

Volume 0
Beginner's Guide

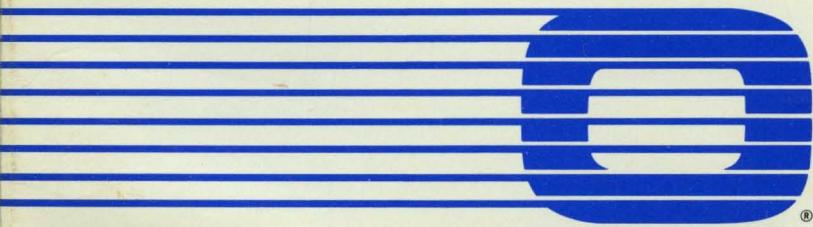

OSBORNETM
COMPUTER CORPORATION

VOLUME 0
**Beginner's
Guide**

OSBORNE
EXECUTIVE
GUIDES

The *Setup & CP/M*, *WordStar*, and *SuperCalc* portions of the *Beginner's Guide* were written by Michael McCarthy. Sharon Rosa Wood and Sue Stanley wrote the Personal Pearl section. Joseph Caggiano was editorial advisor.

Part No. 3F00192-00

All rights to this publication are reserved. No part of this document may be reproduced, transmitted, transcribed, stored in a retrieval system, or translated into any language, in any form or by any means, electronic, mechanical, magnetic, optical, chemical, manual, or in any other manner, without prior permission from OSBORNE COMPUTER CORPORATION, 26538 Danti Court, Hayward, CA 94545.

Copyright © 1983 Osborne Computer Corporation, 26538 Danti Court, Hayward, CA 94545.

Osborne Executive is a registered trademark of Osborne Computer Corporation. WordStar, copyright © 1981, and MailMerge are registered trademarks of MicroPro International Corporation. SuperCalc® and SuperData Interchange are trademarks of Sorcim Corporation. CP/M Plus™ is a trademark of Digital Research Corp. Microsoft BASIC, copyright © 1977-1981, by Microsoft. CBASIC, copyright © by Compiler Software, Inc. UCSD p-System is a trademark of the University of California. Personal Pearl™ is a trademark of Pearlsoft.

Osborne Computer Corporation reserves the right to make changes or improvements to the equipment, software, and documentation herein described at any time and without notice.

Notice: Please be advised that any tampering with the internal hardware of the Osborne Executive Computer may void the warranty.

FCC Notice

This equipment generates and uses radio frequency energy. If not installed and used properly, that is, strictly according to the manufacturer's instructions, the equipment may cause interference with radio and television reception.

This equipment has been type tested and found to comply with the limits for a **Class B** computing device as specified in FCC Rules, Part 15, Subpart J, which is designed to provide reasonable protection against such interference in a residential installation.

If the equipment does cause interference to radio or television reception, which can be determined by turning it ON and OFF, try to correct the interference by doing one or more of the following:

- Reorient the receiving antenna.
- the computer with respect to the receiver.
- Move the computer away from the receiver.
- Plug the computer into a different outlet so the computer and receiver are on different branch circuits.

If necessary, the user should consult the dealer or an experienced radio/television technician for additional suggestions. The user may find the following booklet prepared by the Federal Communications Commission helpful:

"How to Identify and Resolve Radio-TV Interference Problems".

This booklet is available from the U.S. Government Printing Office, Washington, D.C. 20402, Stock No. 004-000-00345-4.

To maintain Class B compliance use properly shielded and grounded cables when connecting this equipment to peripheral devices.

Warning

This equipment has been certified to comply with the limits for a Class B computing device, pursuant to Subpart J of FCC Rules. Only peripherals (computer input/output devices, terminals, printers, etc.) certified to comply with the Class B limits may be attached to this computer. Operation with non-certified peripherals is likely to result in interference to radio and TV reception.

Contents

Introduction **ix**

Lesson 1: Setup and CP/M Plus **2**

What you need to use this Guide	1
How to Use This Beginner's Guide	2
The First Rule of Learning	3
Setting Up the Computer	3
Copy Your Program Disk	6
Formatting Data Disks	10
Ending This Lesson	14

Lesson 2: WordStar **15**

What is WordStar?	15
Special Keys	16
Getting Started	16
The Opening Menu	18
Changing to Drive B	19
Opening a File for Your Letter	19
Saving and Printing the Letter	22
Editing and Correcting Your Letter	25
Deleting Characters	26
Adding Characters	26
Moving Words on a Line	27
Reformatting Line Endings	28

Lesson 3: SuperCalc **31**

What Is SuperCalc?	31
Getting Started	32
The SuperCalc Spreadsheet	33

Loading a Sample Spreadsheet	35
Reviewing the Spreadsheet	37
Using the Sample Spreadsheet	37
Entering More Numbers	39
Making Your Own Spreadsheets	39
Clearing the Screen: ZAP Command	40
Entering Titles and Text	41
Correcting With the BLANK Command	43
Setting Column Widths	44
Days of the Week	45
Dollars and Cents	45
Entering Figures	46
Adding Up a Column	46
Filling in the Spreadsheet	47
Totaling the Week's Expenses	48
The Finished SuperCalc Spreadsheet	49
Storing the Spreadsheet on Disk	50
Reloading the Spreadsheet	50
Printing the Spreadsheet	51
Clearing the Screen	52
Quitting SuperCalc	52
Ending This Lesson	53

Lesson 4: Personal Pearl**54**

What is Personal Pearl?	54
Session 1: Getting Started	55
Using CP/M Plus to Copy Personal Pearl	56
Using Personal Pearl to Copy Programs	63
Personalizing Your Disks	69

Session 2: Using Personal Pearl	73	
Personal Pearl's Demonstration Program		74
The Starter Library	74	
Preparing to Enter Information	74	
Entering Information on the Form	78	
Producing Reports	85	
Editing Stored Information	96	
Summary	101	

Introduction

This Guide will get you **started** using the Osborne Executive.

You don't need to know anything about computers before using it; you'll learn everything as needed.

The Beginner's Guide will:

- **introduce** you to using a computer,
- give you **hands-on experience** with the Osborne Executive,
- teach you enough to begin basic **day-to-day operation** of the computer while learning more,
- make it easier for you to **understand** and use the *Osborne Executive Guides*.

Experienced computer users may skip this Guide and go directly to the *Osborne Executive Guides*.

Each lesson is straightforward and can be completed in one session.

We've included only what you need to use each program; nothing is included that isn't important at this point.

This Guide is divided into Lessons for CP/M Plus, WordStar, SuperCalc and Personal Pearl. **You must do Lesson One: CP/M Plus, first**, in order to prepare disks for use in the other Lessons. WordStar, SuperCalc and Personal Pearl are independent and may be taken in any order.

The first Lesson, **Setup and CP/M Plus**, shows you how to make a working copy of each of your program diskettes. We don't explain CP/M Plus or the details of the COPY program. You'll use CP/M Plus in this Lesson only to make working copies for later use.

The **WordStar** Lesson will teach you how to write a letter using a word processor.

The **SuperCalc** Lesson will show you how to create a business expense report on an "electronic spreadsheet."

In the **Personal Pearl** Lesson, you'll draw up typical business forms and enter data onto them.

Beginner's Guide: Setup and CP/M Plus

Lesson 1: Setup and CP/M Plus

What You Need to Use This Guide:

- A. The Osborne Executive computer
- B. The *Program Disks* supplied with the computer
- C. A *New Blank Disk* for each program disk
- D. A *Printer*, connected to the computer and working properly

Check with your Osborne Dealer about hooking up a printer—it can be a bit intricate.

You can also use the *Beginner's Guide* without a printer but it's less efficient.

How to Use This Guide:

- A. Do Lesson 1, *Setup and CP/M Plus*, *first*. In it you'll prepare working disks for the following lessons.
- B. After finishing Lesson 1, you can go on to the other lessons in any order.
- C. Read the instructions and look at the illustrations.
- D. Perform the numbered steps in sequence.

In Case of Trouble:

*Each lesson has instructions to help you if you push the wrong button, wander off the beaten track, or get an error message. These instructions are labelled **HELP!** If you run into a problem, look at the surrounding text for these **HELP!** instructions.*

The First Rule of Learning:

When in doubt, do SOMETHING.

We designed these lessons to take you from beginning to end with minimal fuss. But it's still possible to push the wrong button or forget a step. If that happens, take a guess — try something and see what it does. If it doesn't work, try another idea. The Osborne Executive is very tolerant.

You might accidentally erase information on screen or disk, but you *CAN'T* break the machine by using the keyboard. You may have to start a lesson over, but that's about the worst that will happen. Fortunately, we made the lessons short!

Setting Up the Computer:

1. Open the power cord compartment as shown in following figure. Plug one end of the power cord into the computer. Plug the other end into an electrical outlet.

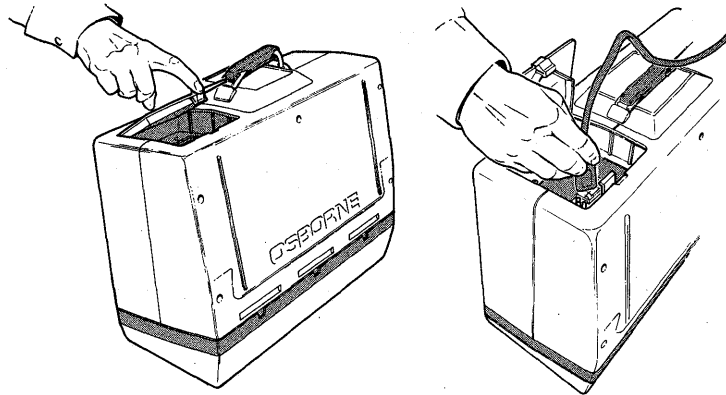

2. Open vent over rear fan panel.
3. Snap open the latches on the front of the computer.

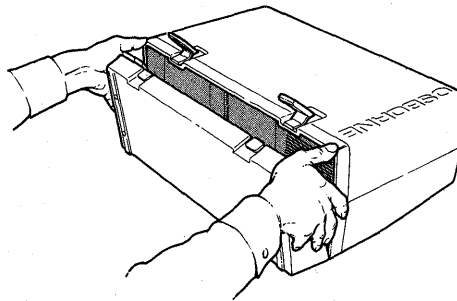

4. Place the front of the computer on the edge of the keyboard for a comfortable viewing angle.

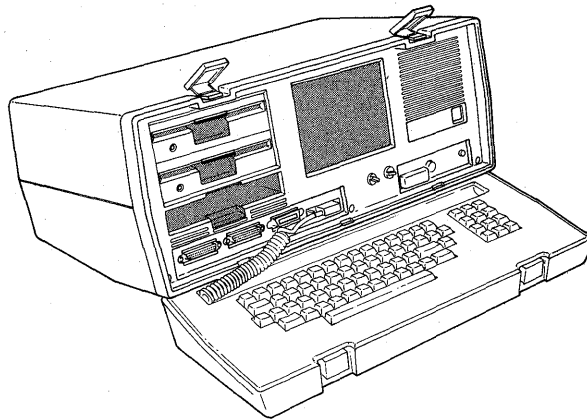

5. Press the ON/OFF button to turn the computer ON. The computer may beep and the screen flash briefly.
6. Adjust the BRT and CONTR knobs on the front of the computer for best screen image. If no image appears at first, these knobs may be turned too low.

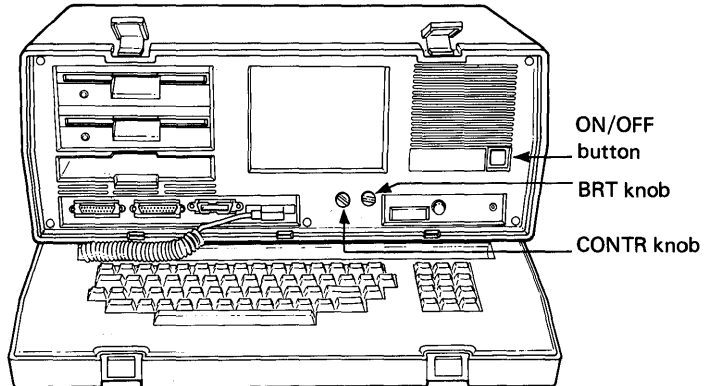

7. The message shown in the figure below appears on screen when the computer is first turned ON or when you press the RESET button.

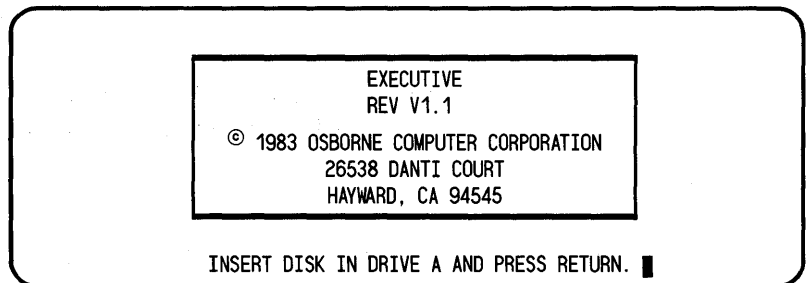

Next we'll make working copies of the program disks supplied with the Osborne Executive. **You MUST make these working copies before proceeding.** We'll explain why in a moment.

The disks you've received with the Osborne Executive are master program disks. They are quite expensive to replace and are factory-protected against overwriting. In these lessons we'll use working **copies** of the master diskettes. If the copies are damaged or lost, you can make new ones from the master disks.

Copy Your Program Disks!

8. The figure below shows how to insert a disk into the computer. Open the drive door. Take the disk labelled **SYSTEM DISK** and insert it into drive **A** exactly as shown in the figure. Gently push the disk into the drive.
9. Carefully close the disk drive door.

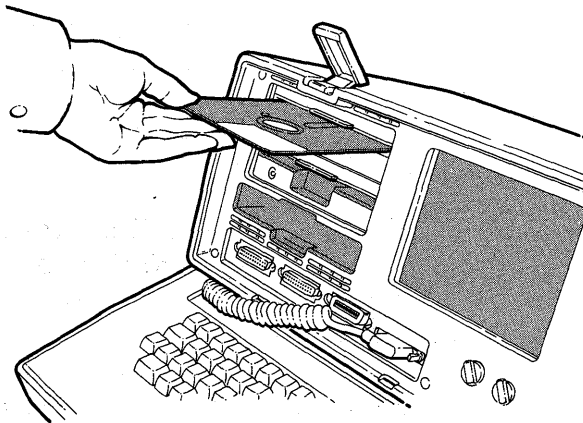

Inserting a disk

WHAT YOU DO

10. Press the **RETURN** key

WHAT THE SCREEN DISPLAYS

A>

When you pressed RETURN, the computer loaded a program from the disk in drive A. The A> symbol is called the "**A prompt**." It appears on screen after the program is loaded.

If there's additional information on your screen, the **A>** should appear below it on the left side of the screen.

Help!

If there's a problem in loading, the screen will display an error message. If this happens, check that you've used the right disk and that it's correctly inserted in the drive. Be sure the drive door is closed, then repeat Step 10.

The **A>** means the computer is ready for instructions. The bright box next to the **A>** is the **CURSOR**. It marks your position on screen. Anything you type will appear at the cursor. You can type capital or lower case characters.

Here's how to copy the program disks.

WHAT YOU DO

11. Type **C O P Y**

WHAT THE SCREEN DISPLAYS

A>COPY

Be sure **COPY** is spelled correctly. To make corrections, press the **LEFT ARROW KEY** on your keyboard. This moves the cursor to the left and erases the letters one by one. Type any corrections needed.

WHAT YOU DO

12. Press the **RETURN** key

WHAT THE SCREEN DISPLAYS

```
Disk Utility Program
Osborne EXECUTIVE Computer System
V1.1
█ Copy Diskettes
  Format Diskettes
  RETURN TO CP/M
```

Use the **ARROW** keys to position the cursor next to the desired choice
or
Press **RETURN** to select a **COPY** option

13. Insert a blank diskette in drive **B** (the bottom drive). The figure on page 6 shows the correct way to insert a disk if you're not sure. Close the drive door.

WHAT YOU DO

WHAT THE SCREEN DISPLAYS

14. Press the **RETURN** key

■ COPY from drive A to drive B
 COPY from drive B to drive A
 RETURN to the Main Menu
 RETURN TO CP/M

Use the **ARROW** keys to position the cursor next to the desired choice
 or
 Insert Diskettes and
 Press **RETURN** to start COPY

15. Press **RETURN** again
 (while copying)
 (then)

Press **Q** and hold to Quit Copying
 Reading Track —
 or Writing Track —
 COPY completed successfully
 Press **RETURN** to continue

16. When you see the message "COPY completed successfully," open the drive doors and remove **BOTH** disks.

Help!

You may see this message on screen:

COPY ERROR - WRITE ERROR - READ ERROR

*This means there's a problem with the disk in drive **B**. Press **RETURN**, then repeat Step 14.*

*If the copy error is repeated, remove the disk and label it **SUSPECT**. Use another blank disk and repeat Steps 13 and 14. If the copy error continues, or you see the message **READ ERROR**, your CP/M Plus disk may be defective. This is very rare. Repeat Steps 13 and 14 several times. If the problem continues, contact your Osborne Dealer.*

Copying your System Disk is an important first step! You'll use the same procedure regularly to copy other disks containing programs and data.

You now have two System Disks — the original and the copy.

17. Write **SYSTEM DISK WORK COPY** on one of the adhesive labels supplied with your disks. Then place the label on the copy you've just made. Set the original System Disk and the copy safely aside.
18. The instructions for copying disks are still in the computer's memory. We'll use them to copy your other program disks.

WHAT YOU DO

19. Insert **WORDSTAR** disk
into drive **A**

Insert **BLANK DISK**
into drive **B**

Close both drive doors.

Press **RETURN**

Press **RETURN**

(while copying)

(then)

Remove both disks.

WHAT THE SCREEN DISPLAYS

■ COPY from drive A to drive B
COPY from drive B to drive A
RETURN to the Main Menu
RETURN TO CP/M

Use the **ARROW** keys to position the
cursor next to the desired choice
or
Insert Diskettes and
Press **RETURN** to start **COPY**

Press **Q** and hold to Quit Copying

Reading Track —
or Writing Track —

COPY completed successfully
Press **RETURN** to continue

19. Label the copy you've just made **WordStar Work Copy**.
20. Insert the **SuperCalc** disk in drive **A** and a blank disk in drive **B**. Repeat Step 18 to copy the SuperCalc disk.

This is a convenient point to copy ALL your master program disks. Insert them one by one into drive **A** and a blank disk into drive **B**. Repeat Step 18 for each program disk.

When you've finished, you'll have a working set of program disks to use with the *Beginner's Guide* and later. If you lose or damage any of the working copies, it's easy to make another from the original.

21. Store your master disks in a cool place—away from dust and electrical or magnetic devices. They'll be available when you need them for more working copies.

There's another important thing to do before we end this lesson. It's called **formatting** disks.

IF YOU WANT TO TAKE A BREAK BEFORE CONTINUING, remove the disks from both drives. Then turn the computer OFF.

When you're ready to resume, start with the following section.

Formatting Data Disks

Formatting is the process of preparing new blank disks for use. You only need to format a disk *once*. If you format it again later, any data on the disk will be erased.

Formatting is part of the COPY program. When you copied the master program disks just now, each blank disk in drive **B** was formatted automatically as the copy was made.

Next, we'll format disks without copying anything onto them. We'll use these formatted blank disks as **data disks** for WordStar text and SuperCalc calculations.

*If you're resuming after a break, then start with **Step 22** below.*

*If you're continuing directly from the COPY program remove the SuperCalc master disk from drive A and insert the working copy of your System Disk, then, start with **Step 27**.*

If You're Resuming After a Break, Start Here:

22. Turn the computer ON. When the SIGN-ON message appears, insert a **copy** of the **System Disk** in drive A.
23. Press the **RETURN** key. The **A>** prompt will appear on screen when CP/M is loaded into the computer.
24. Type **COPY**. If you make a typing error, press the **LEFT ARROW** key on your keyboard. This moves the cursor to the left and erases the letters one by one. Type any corrections.
25. Press the **RETURN** key.
26. Skip to **Step 31**.

If You're Continuing Directly From the Copy Program, Start Here:

27. This message should be at the bottom of your screen:

COPY completed successfully
Press RETURN to continue

WHAT YOU DO

28. Press the **RETURN** key

WHAT THE SCREEN DISPLAYS

■ COPY from drive A to drive B
 COPY from drive B to drive A
 RETURN to the Main Menu
 RETURN to CP/M

Use the arrow keys to position the
 cursor next to the desired choice

or

Insert diskettes and
 Press RETURN to COPY

29. Press the **DOWN ARROW** key to move the cursor to this line: **Return to the Main Menu**

30. Press the **RETURN** key.

31. The screen you see is called the **COPY/FORMAT** menu. It looks like this:

■ Copy Diskettes
 Format Diskettes
 RETURN TO CP/M

Use the **ARROW** keys to position the
 cursor next to the desired choice

or

Press **RETURN** to select a **COPY** option

32. *Remove* the System Disk from drive **A** and *insert* a blank disk in drive **B**.

33. Press the **DOWN ARROW** key to move the cursor to **FORMAT DISKETTES**. This changes the message at the bottom of the screen to:

Press **RETURN** to select a **FORMAT** option

WHAT YOU DO

34. Press the **RETURN** key

WHAT THE SCREEN DISPLAYS

Disk Utility Program
Osborne EXECUTIVE Computer System
V1.1

Format Diskette in Drive A
 Format Diskette in Drive B
 Return to the Main Menu
 Return to CP/M

Use the ARROW keys to position the
cursor next to the desired choice
or

Insert a Diskette in selected drive and
Press RETURN to start FORMAT

Be sure there's a blank disk in drive B.

WHAT YOU DO

35. Press the **RETURN** key

WHAT THE SCREEN DISPLAYS

Disk Utility Program
Osborne EXECUTIVE Computer System
V1.1

Format Diskette in Drive A
 Format Diskette in Drive B
 Return to the Main Menu
 Return to CP/M

Press Q and hold to Quit Formatting

Track Formatted:

0	1	2	3
0123456789012345678901234567890123456789			

*Indicates Good Format E Indicates Format Error

FORMAT completed successfully.
Press RETURN to continue.

HELP!

*If your screen shows the message **FORMAT ERROR**, press ESC key to continue. This repeats the formatting process.*

*If formatting is still unsuccessful after several attempts, use another blank disk in drive **B**. Label the first disk **SUSPECT**.*

This is a convenient point to format more data disks so you'll have a supply ready for use.

36. Remove the disk from drive **B** and label it so you'll know it's formatted.
37. Press the **RETURN** key. This brings you back to the screen in Step 34. The cursor will be at this line:

Format Diskette in Drive B

38. Insert a new, blank disk in drive **B** and press the **RETURN** key. This repeats the formatting process shown in Step 35.

When **FORMAT completed successfully** appears on screen, remove the disk and label it. Then repeat Steps 37 and 38 until you have as many formatted disks as you want.

Ending This Lesson

When you finish formatting, remove any disks from the disk drives. Then turn the computer OFF.

You've learned two important computer operations: copying disks and formatting them. You're ready for any of the other lessons in this book! When you want to continue, go on to the one which interests you most.

Lesson 2: WordStar

What is Wordstar?

WordStar is a word-processing program which uses the computer for various typing tasks. It eliminates the need to retype a document for changes or corrections. With WordStar your writing work will be easier and more productive.

What You Need for This Lesson:

- the Osborne Executive computer
- a **working copy** of the WordStar disk
- a printer. (You can do this lesson without a printer, but it's less efficient).

In This Lesson You Will:

- write a letter
- make revisions
- print a copy

How To Use This Lesson:

- A. **Complete Lesson 1 before starting this one.** You'll need the working copy of the WordStar disk you make in Lesson 1.
- B. **Do the numbered steps in sequence.** Don't be afraid to make mistakes, they won't hurt the computer.
- C. When you do a step, watch what happens on the computer screen.

In this lesson you'll learn basic WordStar commands. When you've finished the lesson, you can go on to more advanced WordStar features in the *Volume 2 — Working With Text and Spreadsheets*.

Special Keys:

Before we start there are three keys you should locate on the keyboard: the **RETURN** key, the **ESC** (Escape) key; and the **CTRL** (Control) key. They're shown below:



In this lesson, we'll refer to these keys and describe what they do.

Getting Started

First, **remove** any disks from the computer's disk drives. If the computer is **ON**, press the **RESET** button on the front of the machine. If the computer isn't **ON**, turn it **ON** now.

This message should appear on your screen:

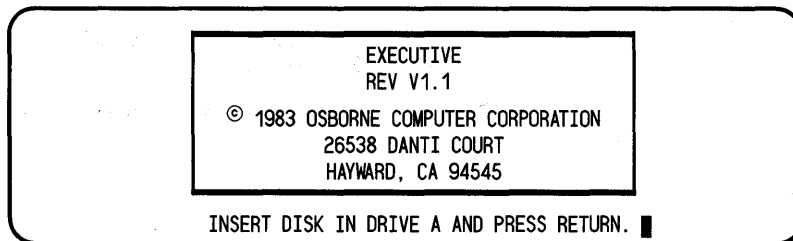

1. Insert the **working copy** of your WordStar disk into Drive **A** and close the drive door. The figure below shows how to insert a disk correctly.

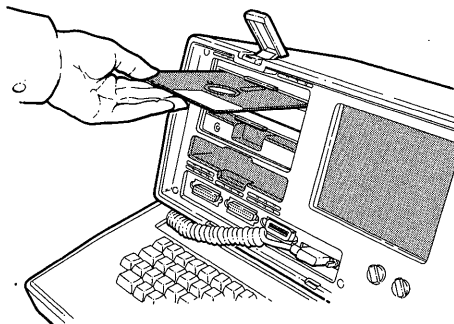

2. Insert a **formatted blank disk** into drive **B**. Close the drive door.

WHAT YOU DO

3. Press the **RETURN** key

WHAT THE SCREEN DISPLAYS

The Opening Menu Screen (see below)

```

not editing
          <<< OPENING MENU >>>
---Preliminary Commands--- | --File Commands-- | -System Commands-
L Change logged disk drive |   | R Run a program
F File directory now ON   | P PRINT a file   | X EXIT to system
H Set help level         |   | -WordStar Options-
---Commands to open a file---| E RENAME a file | I Run StarIndex
D Open a document file   | O COPY a file   | M Run MailMerge
N Open a non-document file| Y DELETE a file | S Run SpellStar

DIRECTORY of disk A:
SAMPLE.TXT   AUTOST.COM   WS.COM
WSMSG5.OVR  WSOLVLY1.OVR
  
```

Opening Menu Screen

Several screens of information — WordStar version number, copyright information — go by until finally the Opening Menu appears on the screen.

The Opening Menu

Look at the screen. The top line says **NOT EDITING** and below that, **OPENING MENU**. This “menu” is the screen you’ll see when you’re not typing or editing a document.

After you file away a document, the Opening Menu always reappears, waiting for instructions. This menu allows you to type a document, revise it, or print a copy.

Check the screen again. It shows a series of letters and the commands they stand for. The letter **D**, for example, is the command to **Open a document file**.

In this lesson, **D**, **L** and **P** are the only commands you’ll need from the Opening Menu.

The screen also shows the **Directory of disk A**. This is a list of files or documents on the disk in drive **A**.

Help!

*If you press a key by accident while the Opening Menu is on screen, press the **ESC** key to cancel the command.*

*If you press the letter **X** on this menu, the **A>** prompt will appear at the bottom of the screen. Type **W** **S** and press **RETURN** to return to WordStar.*

Changing To Drive B

We'll write our sample letter on the data disk in drive B.

WHAT YOU DO

4. Press L

Type B,
then press the RETURN key

WHAT THE SCREEN DISPLAYS

The logged disk drive is now A:
New logged disk drive (letter, RETURN)?

Drive B is now the active drive. The Opening Menu looks the same as before except that it shows the **Directory of Disk B**.

Opening a File for Your Letter:

To the computer, a letter is a document. Look at the screen and find **D= Open a document file**.

WHAT YOU DO

5. Press D

WHAT THE SCREEN DISPLAYS

Name of file to Edit?

WordStar keeps track of documents by name. If you type in a name, it creates file space on the disk under that name. If you type a name already on file, the program gets out that document so you can edit it. We'll use LETTER as our file name.

WHAT YOU DO

6. Type L E T T E R

WHAT THE SCREEN DISPLAYS

Name of file to Edit? LETTER

Help!

If you make an error while typing LETTER, use the LEFT ARROW key to backspace. It will erase the letters one-by-one. Then type the correction.

WHAT YOU DO

WHAT THE SCREEN DISPLAYS

7. Press the **RETURN** key

The Main Menu screen (see below)

```

B:LETTER PAGE 1 LINE 1 COL 01          INSERT ON
      <<<          M A I N  M E N U          >>>
--Cursor Movement--      !-Delete- !      -Miscellaneous- !      -Other Menus-
^S char left ^D char right !^G char ! ^I Tab  ^B Reform ! (from Main only)
^A word left ^F word right !DEL chr lf! ^V INSERT ON/OFF  !^J Help  ^K Block
^E line up  ^X line down  !^T word rt! ^L Find/Replce again! ^Q Quick ^P Print
--Scrolling--           !^Y line  !RETURN End paragraph! ^O Onscreen
^W up line  ^Z down line  !      ! ^N Insert a RETURN !
^R up screen ^C down screen!      ! ^U Stop a command !
L-----|-----|-----|-----|-----|-----|-----|-----|-----R

```

Main Menu Screen

Look at the screen. This is the Main File Menu. You'll see it while typing or editing a document. Like the Opening Menu, this one lists common WordStar editing commands.

In a moment, you'll be typing a sample letter. Read these instructions before you start:

- type as you would with an ordinary typewriter.
- don't try to correct typing errors. You'll do that later.

- press the **RETURN** key *only where indicated* in the sample letter.
 - don't insert a carriage return except to start a new paragraph. WordStar *automatically* inserts carriage returns at the end of each line.
 - use the TAB key or spacebar to indent.
8. Type the following letter. Don't try to correct mistakes. Press RETURN where indicated.

June 15, 1983 **RETURN**

RETURN

Evans Brothers Inc. **RETURN**

Attn: Dan Evans **RETURN**

1225 Beach Drive **RETURN**

Hayward, California 94545 **RETURN**

RETURN

Dear Dan: **RETURN**

RETURN

Thanks for your letter of May 30th. I've researched your request for information on the Delaney project we completed last year. Attached are some brochures and a project-end report that should provide the figures you need. **RETURN**

RETURN

If you want more specific information, I'll be happy to help. Just give me a call. **RETURN**

RETURN

Yours truly, **RETURN**

RETURN

RETURN

RETURN

Robert P. Walkin **RETURN**

Vice President **RETURN**

RETURN

Encl. **RETURN**

CONGRATULATIONS! You've used the computer to type a business letter!

You can see only some of the letter on screen at the moment, but the whole thing is there in the computer.

So far it's not too different from typing on a typewriter.

There should be some typing errors and misplaced words in your letter, unless you're a very good typist indeed! **Don't try to correct them yet**—you'll need them later.

First, though, let's print out a copy of the letter as it looks now. This will be a rough draft for comparison purposes. Later, after making corrections, you'll print a second copy.

Saving and Printing the Letter

Before printing the letter, you need to file it.

WHAT YOU DO

9. Hold down the **CTRL** key and type **K**

WHAT THE SCREEN DISPLAYS

The Block Menu Screen (see below)

```

^K          B:LETTER      PAGE 1 LINE 1 COL 01      INSERT ON

          <<< BLOCK MENU >>>

-Saving Files- | -Block Operations- | -File Operations- | -Other Menus-
S Save & Resume | B Begin K End   |R Read   P Print   | (from Main only)
D Save--done   | H Hide / Display |O Copy   E Rename   | ^J Help ^K Block
X Save & exit   | C Copy   Y Delete|J Delete        | ^Q Quick ^P Print
Q Abandon File | V Move   W Write | -Disk Operations- | ^O Onscreen
  -Place Markers- | N Column now OFF |L Change logged disk|Space bar returns
0-9 set/hide 0-9|                          |F Directory now OFF |you to Main Menu
L-----R

```

The **CTRL** key works like the shift key on a typewriter. To get capitals on a typewriter, you hold down the shift key and type the letter. To issue certain kinds of **CONTROL COMMANDS** on the computer, you hold down the **CTRL** key and type a letter. The principle is the same, except that you get a computer command instead of a capital letter.

CTRL-K is a **PREFIX** for the group of commands shown on screen. You've already entered the **CTRL-K** part of the command. Now you need the second part.

Look at the menu on screen. The command we want is on the upper left: **D Save — done**. Pressing **D** after giving a **CTRL-K** command saves your document on disk. That's what you want to do.

WHAT YOU DO	WHAT THE SCREEN DISPLAYS
10. Press <input type="text" value="D"/>	WAIT
(then)	Savings File B:Letter

The letter you typed is stored on the disk in drive **B**. It's listed as a file called **LETTER** in the Directory of Disk **B** you see on screen. Now that the letter is saved, you can print it.

Check the Opening Menu currently on screen. One of the commands listed is **P = Print a file**.

WHAT YOU DO	WHAT THE SCREEN DISPLAYS
11. Press <input type="text" value="P"/>	Name of file to print? █
12. Type <input type="text" value="LETTER"/>	Name of file to print? LETTER

Help!

Be sure LETTER is spelled correctly. If it isn't, use the LEFT ARROW key to backspace and erase the error(s). Then type the correction(s).

13. Check that your printer is turned ON and properly connected to the computer. Press the **[ESC]** key to start printing.

Printing Help!

1. If you press the RETURN key instead of ESC, you'll display printer options on screen. Slowly press the **[RETURN]** key several more times until you see the message **Ready Printer, press RETURN**. Press the **[RETURN]** key again to start the printer.
2. If the screen says **FILE LETTER NOT FOUND**, you've mistyped the word LETTER in Step 11 or Step 6. Look at the Directory of Disk **B** on screen. Repeat Steps 11 and 12 using the exact spelling shown for the LETTER file.
3. If you wish to stop printing, press **[P]**. The message **Y TO STOP, N TO RESUME, P TO PAUSE** will appear at the top of the screen. Press one of these letters for the corresponding action.
4. If the printer doesn't start, check the cable connections and connect if not connected; on some printers, you may have to repeat the printing process from Step 11. Printer interface is complex: if you still have trouble, skip the printing portion and continue with the lesson. (To do this, you may have to remove the disks, turn the computer off and then on again, and restart WordStar.) Then see your dealer about the printer.

Remove the printed page from the printer and examine it. Notice that WordStar automatically set the margins and the number of lines per page. It also "right-justified" the text so all the lines end evenly.

You can change any of these features when you're more familiar with WordStar. Right now, though, let's go back and make corrections to the letter.

Editing and Correcting Your Letter

First, **mark on your printed copy** any typographical errors, misplaced words, or other corrections you'd like to make.

Note:

In order to make the right margin come out even, WordStar sometimes adds spaces between words. Don't try to delete these extra spaces, since WordStar will just put them back in.

If you have few errors, you may want to insert words or phrases to see how WordStar's editing features work.

WordStar has many ways to modify a document. We'll make the following corrections:

- **deleting** characters
- **adding** characters
- **moving words** on a line
- **reformatting** or fixing line endings after editing.

To edit the letter, you need to reopen the file LETTER.

14. The Opening Menu should be on your screen. Press **D** (for Open a File). Then type **L E T T E R** and press **RETURN**. Your original letter will reappear.

If you misspelled LETTER, a new file will be created although there will be nothing in it. Press **^K Q** to return to the Opening Menu.

The editing commands we'll describe work at the cursor position. When you're ready to delete or add a character, use the ARROW keys to move the cursor into position.

Deleting Characters

WordStar can delete letters, words, lines, or entire paragraphs. For simplicity, you'll delete only one character at a time.

CTRL-G is the **DELETE CHARACTER** command. To use **CTRL-G**, position the cursor over the letter you wish to delete. Then **HOLD DOWN** the **CTRL** key and press **G** once. The character at the cursor position is erased!

When the character disappears, the rest of the word automatically closes up the space.

Select a character to delete. Now use the ARROW keys to move the cursor to the character. When the cursor's in position, hold down the **[CTRL]** key and press **[G]** once.

Don't worry about deleting the wrong character or too many characters. You'll soon see how to insert any characters you need. Don't worry about line endings, either. You'll fix them later.

Adding Characters

To add a character, use the ARROW keys to position the cursor where you want the character. Then, just type the character.

WordStar **inserts** the new character at the cursor position, moving the text to the right to make room for it. Find a place in your letter where you need to add a character. Move the cursor to that position and type the character.

If you make a mistake when adding a character, use **CTRL-G** to delete it. Then type the correction.

Moving Words on a Line

You may need to indent some of the lines in your letter or line up the signature block. The easiest way to do it is by adding or deleting spaces:

- to move a word (or line) **to the right**, position the cursor at the beginning of the word. Press the Spacebar to move the word one space at a time to the right. If you move the word or line too far over, you can move it back.
- to move a word (or line) **to the left**, position the cursor where you want to move the word. Use **CTRL-G** to delete the spaces between the cursor and the word. The word will move one space to the left each time you type **CTRL-G**.

Find a word or line which needs to be moved, then move it by adding or deleting spaces.

Editing Help!

1. *If characters you ADD write over existing ones instead of moving them, you've accidentally turned OFF the Insert feature. To turn it back ON:*

*Hold down the **CTRL** key and press **V** once. Check that the words **INSERT ON** appear at the top of your screen. If they don't, repeat the **CTRL-V** command.*

2. *To move the cursor to the right on a blank line or past the end of a line use the spacebar instead of the **ARROW** keys. The **ARROW** keys won't move the cursor to spaces where no text has been entered.*

15. Now that you've read about deleting, adding, and moving text, GO BACK and EDIT YOUR LETTER until you're satisfied with it. Take your time and refer to the preceding paragraphs as needed. Don't worry about the line endings now.

When you've finished adding and deleting characters, go on to the discussion below.

Reformatting Line Endings

As you made corrections to your letter you probably found that it became a bit ragged, with some lines longer than others. WordStar will quickly even up your text with the right margin.

16. Use the ARROW keys to move the cursor to the first line of the first paragraph. Then hold down the **[CTRL]** key and press **[B]** once. This is the REFORMAT command, **CTRL-B**.

WordStar will fix the line endings in the first paragraph. Reformatting takes only a moment. When it's done, the cursor will appear at the end of the first paragraph.

17. Use the ARROW keys to move the cursor to the first line of the second paragraph. Enter **CTRL-B**, and the second paragraph will reform.

Notice that the paragraph line endings are now even.

Help!

*During reformatting, the cursor may stop in the middle of a word at the end of a line. If so, there'll be a message at the top of your screen asking whether you want to hyphenate the word. For now, enter **CTRL-B** to continue reformatting without hyphenation.*

Congratulations!!

You've used WordStar to edit your letter, make corrections, and justify the line endings.

Before printing the corrected copy, you need to save it on disk again.

18. CTRL-K starts the save process. Hold down the **CTRL** key and press **K**. When the Block Menu appears on screen, press **D**.

This files the corrected version of your letter on disk in place of the old version. Watch the screen. When WordStar has filed the letter, the OPENING MENU and the Directory of Disk B will appear. This means you can print a copy as before.

WHAT YOU DO

19. Press **P** (for Print)

Type **L E T T E R**

WHAT THE SCREEN DISPLAYS

Name of File to print?__

Name of File to print? LETTER

Help!

Be sure LETTER is spelled correctly. If it isn't, use the LEFT ARROW key to backspace and erase the error(s). Then type the correction(s).

The LETTER file contains the corrected version of your letter. The old version is now called LETTER.BAK.

20. Check that your printer is turned ON and connected properly to the computer. Press the **ESC** key to start printing.

Printing Help!

If you accidentally pressed the RETURN key or have a problem with printing, see the PRINTING HELP given when you printed LETTER the first time.

Ending This Lesson

You've completed your first WordStar lesson. The hardest part of WordStar is behind you! While WordStar has many more commands, the ones you've learned are the foundation for the rest.

You can go on to the SuperCalc or Personal Pearl lessons in the *Beginner's Guide*. Or you can proceed to the WordStar chapter in the *Volume 2—Working with Text and Spreadsheets*. There you'll learn WordStar features which make any writing job easy to handle.

If you've finished using the computer for now, remove the disks from the drives and store them safely. Then turn the computer OFF.

Lesson 3: SuperCalc

What Is SuperCalc?

SuperCalc is a program for making numerical calculations and forecasts. You can enter numbers, manipulate them, and see the results on screen immediately. SuperCalc is a powerful tool for handling numbers data quickly and efficiently.

What You Need For This Lesson:

- the Osborne Executive computer
- a **working copy** of the SuperCalc disk
- a formatted blank disk
- a printer (optional)

In This Lesson You Will:

- draw up a spreadsheet
- make calculations on it
- print a copy (optional)
- store the spreadsheet on disk

How To Use This Lesson:

- A. **Complete Lesson 1 before starting this one.** You'll need the working copy of the SuperCalc disk you make in Lesson 1.
- B. **Do the numbered steps in sequence.** Don't be afraid to make mistakes, they won't harm the computer.
- C. When you do a step, watch what happens on the computer screen.

Getting Started

First, **remove** any disks from the Osborne Executive's disk drives. If the computer is ON, press the RESET button on the front of the machine. If the computer isn't ON, turn it ON now.

This message should appear on your screen:

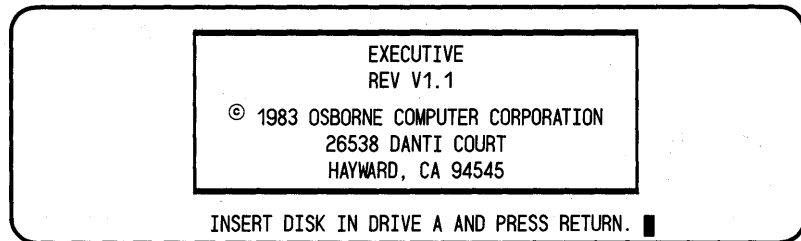

1. Insert the **working copy** of your SuperCalc disk into drive **A** and close the door. The figure below shows how to insert a disk correctly.

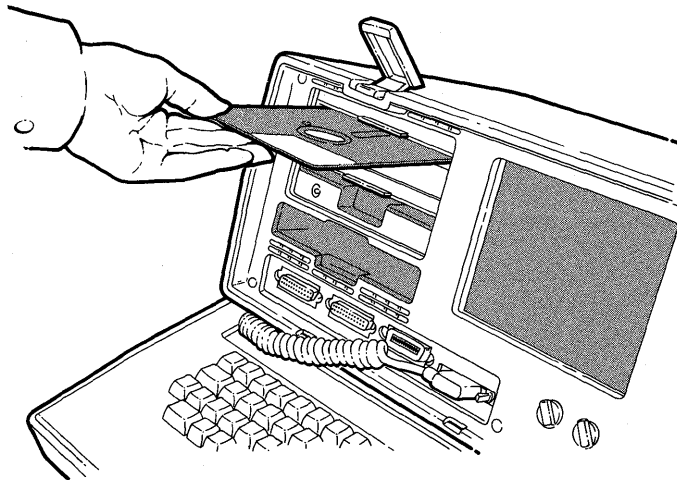

2. Insert a **formatted blank disk** into drive **B**. Close the drive door.

WHAT YOU DO

WHAT THE SCREEN DISPLAYS

(after several moments)

3. Press the **RETURN** key.

Loading SuperCalc

Look at the bottom line on screen. It says **Enter "?" for HELP or "return" to start**. Typing a question mark will display a HELP screen. Pressing the RETURN key will start SuperCalc.

4. Press the **RETURN** key.

The SuperCalc Spreadsheet

Pressing the RETURN key displays the **spreadsheet**:

```
  I  A  B  C  D  E  F  G  H
1: ██████████
2:
3:
4:
5:
6:
7:
8:
9:
10:
11:
12:
13:
14:
15:
16:
17:
18:
19:
20:
21:
>A1
Width: 9 Memory:27 Last Col/Row:A1 ? for Help
1>
```

The spreadsheet is the work area on screen for entering data and making calculations.

The letters **A** through **H** across the top of the spreadsheet designate columns. The numbers down the left side of the screen designate rows.

The highlighted box in the upper left corner of the spreadsheet is the **cursor**. The cursor marks your position on screen. When the blank spreadsheet first appears, the cursor is in column **A**, row **1**. This is called **A1**.

You can move the cursor around the screen by pressing the **ARROW** keys on your keyboard.



Press these keys a few times and watch the cursor move. Try not to move off the right side of the screen or below the bottom. If you do, you'll be in a part of the spreadsheet we're not interested in yet.

You can bring the cursor back to position **A1** using the **ARROW** keys.

Help!

MOVING THE CURSOR

If you move the cursor off the right side of the screen or below the bottom, return to Cell A1 this way. Type:

`= A 1`

Be sure to type an equals sign (=) in front of A1. Then press the `RETURN` key.

Loading a Sample Spreadsheet

`/L` **Load Command**

Before creating your own SuperCalc spreadsheet, we'll load a sample one so you can see how a completed spreadsheet looks. The sample spreadsheet is named **BRKEVN**.

WHAT YOU DO

5. Press the slash key: `/`
(It's on the same key as the question mark (?))

WHAT THE SCREEN DISPLAYS

(near the bottom of the screen)

Enter B,C,D,E,F,G,I,L,M,O,P,
Q,R,S,T,U,W,X,Z,?''

The slash key `/` is the SuperCalc **command prefix**. It notifies SuperCalc that your next entry will be a command.

Help!

If you pressed the SHIFT key before the slash (/), you'll see a screen called the HELP menu. Press any key to return to the spreadsheet. Then repeat Step 5.

WHAT YOU DO

6. Press L

7. Type B R K E V N
then press the RETURN key.

WHAT THE SCREEN DISPLAYS

Enter File Name (or
<RETURN> for directory)
/Load,

A(11) or P(art)?
/Load, BRKEVN,

Help!

TYPING MISTAKES

If you make a typing mistake, use the LEFT ARROW key to backspace the cursor and erase the error OR use the SPACE BAR to delete extra letters. Then repeat Step 7.

*If you misspell **BRKEVN** or this sample spreadsheet isn't on your SuperCalc disk, you'll see the message **File NOT on Disk** after pressing RETURN in Step 7.*

Check your spelling. Then repeat Step 7.

WHAT YOU DO

8. Press A

WHAT THE SCREEN DISPLAYS

(BRKEVN Spreadsheet)

The sample SuperCalc spreadsheet called **BRKEVN** loads into the computer, then appears on screen.

	A	B	C	D	E
1:	Break Even Analysis		Units Sold	Profit or Loss	
2:	Product Name		100	.00	
3:	Retail Price	.00	200	.00	
4:			300	.00	
5:	Fixed Costs	(Totals)	400	.00	
6:	Development	.00	500	.00	
7:	Marketing	.00	600	.00	
8:	Other	.00	700	.00	
9:	TOTAL Fixed Cost	.00	800	.00	
10:			900	.00	
11:	Variable Costs	(Per Unit)	1000	.00	
12:	Labor	.00	1100	.00	
13:	Materials	.00	1200	.00	
14:	Packaging	.00	1300	.00	
15:	Other	.00	1400	.00	
16:	TOTAL Variable Cost	.00	1500	.00	
17:			1600	.00	
18:	Quantity Increment	100	1700	.00	
19:	Discount Rate (%)	50	1800	.00	
20:			1900	.00	
21:			2000	.00	
<A1	P Text=''	Break Even Analysis			
Width:29	Memory:23	Last Col/Row:D32	? for Help		
1>					

BRKEVN Spreadsheet

Reviewing the Spreadsheet

The sample spreadsheet on your screen is called a Break Even Analysis. You enter the retail price, discount, the fixed and variable costs of some item or product. SuperCalc then calculates profit and loss. If you change a number, SuperCalc automatically adjusts the results.

Using the Sample Spreadsheet

We'll use the sample spreadsheet for some SuperCalc practice.

9. Use the ARROW keys to move the cursor to row 3 in column B. This is the first .00 entry in the column.

WHAT YOU DO

10. Type

WHAT THE SCREEN DISPLAYS

>B3 Form=0
Width: 12 Memory: 23 Last Col/Row: D32
2.98

Help!**FIXING TYPING ERRORS**

As you type 2.98, it appears on the bottom line of your screen. Whatever you type will appear here so you can check it before sending it to the spreadsheet.

To correct errors on this line, use the LEFT ARROW key to backspace over the errors. Then type the correction. To erase extra characters, use the .

*To cancel the entire entry, use the LEFT ARROW key to backspace to the left margin. Then back up **one more time**. The entire entry will disappear.*

IF THE CURSOR WON'T MOVE

The cursor won't move if there's something written on the bottom line of the screen. If the cursor seems to be stuck when you try to move it, check the bottom line and delete any characters there.

When you've typed 2.98 correctly, watch column D on screen and press the key. SuperCalc recalculates the values in column D (profits) based on the new entry 2.98 in column B.

Notice that the cursor has also moved from **B3** to a neighboring position. The cursor automatically moves in the same direction it had been going. It's always a good idea to check the screen to make sure of the cursor's position.

Entering More Numbers

11. Move the cursor down column **B**. Repeat Step 10 to enter numbers where there are now zeros. Watch the effect on column **D**.

Tips For Typing Numbers

*Make new entries ONLY where there are zeros, not in the blank spaces. Don't use commas in the numbers. For example, type **1000**, not **1,000**.*

Practice entering numbers a bit. When you're familiar with how to do it, go on to the following.

Making Your Own Spreadsheet

Now that you've seen a sample SuperCalc spreadsheet, it's time to create your own. We'll call it **Expense Report**.

First, we'll clear the sample spreadsheet from the screen.

WHAT YOU DO

12. Press the slash key

WHAT THE SCREEN DISPLAYS

Enter B,C,D,E,F,G,I,L,M,O,P,
Q,R,S,T,U,W,X,Z,?''

Clearing the Screen: ZAP Command

Zap Command

WHAT YOU DO

13. Type Z

14. Type Y

WHAT THE SCREEN DISPLAYS

Y(es) to clear everything, else N(o)
Zap-ENTIRE-Worksheet?

(A blank spreadsheet appears)

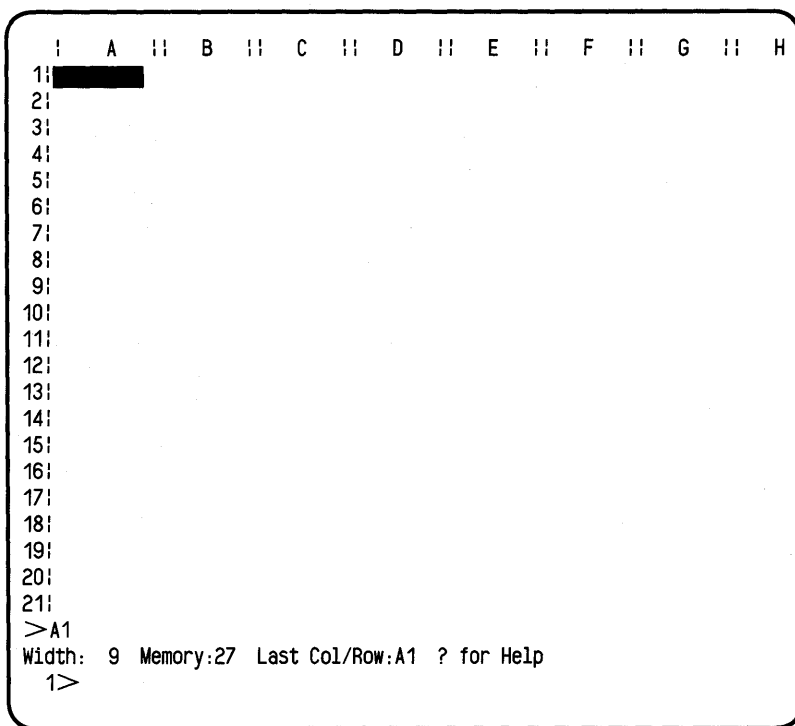

SuperCalc removes the sample spreadsheet contents from the screen. It's still on the SuperCalc disk though. What you are left with is a blank spreadsheet to work with.

Entering Titles and Text

Use the ARROW keys to move the cursor to position **A1** (column **A**, row **1**). To enter text on the spreadsheet:

- position the cursor where you want the text to appear
- type a quotation mark `"`. This signals SuperCalc that the next entry will be text rather than numbers.
- type the word or text
- press the `RETURN` key

Figure 1 below is the text for your SuperCalc spreadsheet. We put quotation marks in Figure 1 **as a reminder** to begin each text entry with a quotation mark. The quotation marks won't appear on screen.

15. Enter all the text shown in Figure 1. After the first entry, **Expense Report**, use the ARROW keys to move the **S** cursor to the next position.

```

1 | A || B || C || D || E || F || G || H |
2 | "EXPENSE REPORT
3 |
4 | "CITY:
5 | "STATE: (Don't forget the quote mark!)
6 | "TRAVEL:
7 | " AIR, RAIL
8 | " CAR RENT: (Use quote, then spacebar to indent.)
9 | " AUTO EXP:
10 | " TAXI:
11 | "MEALS:
12 | "ENTERTAIN:
13 | "MISC:
14 |
15 | "DAILY TOTAL:
16 |
17 | " WEEK'S EXPENSES:
18 |
19 | " ITEMIZE BELOW; ATTACH RECEIPTS
20 |

```

FIGURE 1. Creating a Spreadsheet

Help!

TYPING ERRORS

*Use the ARROW keys to move the cursor for corrections. If you make an incorrect entry, place the cursor on it. Type the correction. Then press the **RETURN** key. The corrected entry will replace the incorrect one.*

QUOTATION MARK PROBLEMS

*If you forget to begin each entry with a quotation mark (very common!), you'll see the message **FORMAT ERROR**. Backspace the cursor to the left margin and retype the entry. Then press **RETURN**.*

Help!

APOSTROPHE INSTEAD OF QUATOATION MARK

If you type an apostrophe (') instead of a quotation mark ("), the word you enter will repeat across the screen. Move the cursor to the entry and erase it with the LEFT ARROW key. Then retype the word beginning with a quotation mark.

Correcting With the BLANK Command

Blank Command

One way to correct an entry on the spreadsheet is to move the cursor to it and then type the correction. SuperCalc also has a command called BLANK which lets you erase an entry entirely. Here's how to use the BLANK command.

First, move the cursor to an empty location on the spreadsheet.

WHAT YOU DO

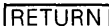

WHAT THE SCREEN DISPLAYS

16. Type your name (start with a quotation mark). Press the  key.

Your name (at the bottom of the screen)
Your name (on the spreadsheet)

17. Place the cursor on your name.

Enter B,C,D,E,F,G,I,L,M,O,P,
Q,R,S,T,U,W,X,Z,?

18. Press the slash key  and type .

Enter Range
/Blank,

19. Press the  key.

Blanking... (the cursor location)

Your name is erased or "blanked" from the spreadsheet. Blanking and retyping are the only ways of correcting errors you need at this point. Retype or blank as many errors as you wish. When you're satisfied, go on to the next section below.

Setting Column Widths

F *Format Command*

Column A on your **Expense Report** needs to be widened to fit the row titles. The **FORMAT** command is the way to do it.

WHAT YOU DO

20. Type **F**

21. Type **C** (for column)

22. Type **A** (for column A)
and press the **RETURN** key.

23. Type **1** **2** and press
the **RETURN** key.

WHAT THE SCREEN DISPLAYS

Enter Level:G(lobal),C(olumn), R(ow), or
E(ntry)
/Format

Enter Column Letter
/Format,Column,

Define Formats: (I,G,E,\$,...)
/Format,Column,A,

(Column A changes from 9 to 12
characters wide)

Help!

If you press the wrong key in one of these steps, you'll see an ERROR MESSAGE near the bottom of your screen. In this case, backspace the cursor over the instruction you've typed to erase the error. Then repeat the step.

The other columns of your **Expense Report** are already the right width and don't need to be changed.

Days of the Week

24. The next step is to add days of the week to the Expense Report. Enter them on your spreadsheet as shown in Figure 2, together with **NAME** and **EMPL. NO.** The quotation marks (") are a reminder. They won't appear on screen.

```

1      A      B      C      D      E      F      G      H
1:EXPENSE REPORT          'NAME:
2:                               'EMPL. NO.
3:                'MON 'TUE 'WED. 'THUR 'FRI 'SAT 'SUN
4:CITY:
5:STATE:
6:TRAVEL:
7: AIR, RAIL

```

FIGURE 2. Entering Days of the Week

Dollars and Cents

Before entering some numbers on the Expense Report, we'll instruct SuperCalc to use dollars and cents format. This means SuperCalc will automatically insert a decimal point between the "dollar" part and the "cents" part of each number.

WHAT YOU DO	WHAT THE SCREEN DISPLAYS
25. Type <input type="checkbox"/> <input type="checkbox"/> (for Format)	Define Formats:I,G,E,\$,R,L...
26. Type <input type="checkbox"/> (for Global)	/Format,Global
27. Type <input type="checkbox"/> (use the SHIFT key) and press the <input type="checkbox"/> key	(Formatting accomplished)

There's no change on screen at the moment. But, in the next step, when you enter numbers under "days of the week," SuperCalc will include decimals.

Entering Figures

Let's enter some sample figures in the "Monday" column.

28. First, move the cursor to location **B4** (column **B**, row **4**) of the **Monday** column. Type the name of a city (begin with a quotation mark (")). Move the cursor down one line and type the state abbreviation. (See Sample Figure 3.)

Notes on Numbers

- you don't need the quotation mark when entering numbers
 - don't include the dollar sign (\$)
 - don't include commas (1,000); just type the number (1000)
 - in the format we're using, SuperCalc rounds off dollars and cents: 90 becomes 90.00 and 9.3 becomes 9.30
29. Stay in column **B**, but move the cursor down to line 7, "AIR, RAIL." Type in some dollar figures on lines 7 through 13 as your Monday expenses.

Adding Up a Column

So far, so good. Now we'll have SuperCalc do some work. Let's add up the figures in column **B**.

30. Move the cursor to line 15, "DAILY TOTAL," in column B. Enter the following, exactly as shown (NO quotation mark!):

S **U** **M** **(** **B** **7** **:** **B** **1** **3** **)**

This is a **formula**, not text. It doesn't need a quotation mark.

Watch line 15 and press the **RETURN** key. SuperCalc adds the numbers you entered in column B and displays the total at B15.

If you change the numbers in column B, the total will change automatically. Try it.

31. Change one or more numbers between B7 and B13. Watch the total in line 15 change.

Filling in the Spreadsheet

Complete the other "days of the week" columns. This will give us some numbers to work with. When you've filled in the week's expenses, it's time to total them up.

You could do it by using the SUM formula in Step 30 for columns C through H. But you'd have to change the column letters each time (C7:C13 in column C, D7:D13 in column D, and so on).

There's a faster way to add the figures with the command called REPLICATE.

⇧ **R** *Replicate Command*

WHAT YOU DO

WHAT THE SCREEN DISPLAYS

32. Type **[] [R]**

From? (Enter Range)
/Replicate,

33. Type **[B] [1] [5]** (the formula you're copying is at B15), then press the **[RETURN]** key.

From? (Enter Range), then
Return; or ' ', ' ' for Options
/Replicate,B15.

34. Type **[C] [1] [5] [:] [H] [1] [5]** (the range over which you're copying the formula), then press the **[RETURN]** key.

(Formula replicated)

SuperCalc fills in the formula across row 15 and calculates the results. It also automatically adjusts the SUM formula to read C7:C13 in the C column, D7:D13 in the D column, etc. If you move the cursor to C15 or D15, you'll see that the formula has been adjusted by the REPLICATE command.

Totaling the Week's Expenses

On the spreadsheet you've created, the Week's Expenses will be the sum of the Daily Totals in row 15.

WHAT YOU DO

WHAT THE SCREEN DISPLAYS

35. Move the cursor to D17.

36. Type **[S] [U] [M] [(] [B] [1] [5] [:] [H] [1] [5] [)]**
(No quotation mark!)

(Sum of Daily Totals appears at D17)

37. Press the **[RETURN]** key.

The Finished SuperCalc Spreadsheet

Congratulations! You've completed your Expense Report using SuperCalc. Figure 3 shows a typical completed example.

	A	B	C	D	E	F	G	H	
1: EXPENSE REPORT	NAME:								
2:									
3:	MON	TUE	WED	THUR	FRI	SAT	SUN		
4: CITY:	SAN FRANCISCO			ALL WEEK		DENVER			
5: STATE:	CA					CO			
6: TRAVEL:									
7: AIR, RAIL	456.00								
8: CAR RENTAL	.00	.00	.00	.00	156.00	.00	.00		
9: AUTO EXPEN.	.00	.00	.00	.00	.00	.00	.00		
10: TAXI, TOLLS	13.00	5.00	5.00	55.00	5.00	30.00	.00		
11: MEALS	34.00	25.00	25.00	25.00	125.00	.00	.00		
12: ENTERTAIN.	5.00	.00	45.00	23.00	100.00	.00	.00		
13: MISC.	13.00	12.00	45.00	34.00	23.00	6.00	.00		
14:									
15: DAILY TOTAL:	521.00	42.00	120.00	137.00	409.00	36.00	.00		
16:									
17:	WEEK'S EXPENSES	1265.00							
18:									
19:	ITEMIZE BELOW; ATTACH RECEIPTS								
20:	TRIP TO SAN FRANCISCO FOR SALES MEETING WITH ALLIED								
21:	RECEIPTS ATTACHED								

FIGURE 3. Completed Expense Report

There's another feature of SuperCalc you should see before printing your spreadsheet.

Change some of the numbers on your spreadsheet. SuperCalc will adjust the totals automatically! You see how easy it will be to update your spreadsheets or see the effect of different figures.

You may be doing more complicated things than expense reports, of course. But SuperCalc handles even complex calculations quickly and efficiently.

Storing the Spreadsheet on Disk

[F][S] *Save Command*

By storing the spreadsheet on disk, you'll save all the data you've entered.

First, be sure there's a formatted work disk in drive **B**.

WHAT YOU DO

42. Type **[F][S]** (for SAVE).

43. Type **[B][:][T][E][S][T]**, then press the **[RETURN]** key.

44. Type **[A]**

WHAT THE SCREEN DISPLAYS

Enter File Name (or <RETURN> for directory)
/Save,

A(11), V(alues), or P(art)?

(SuperCalc stores the spreadsheet on disk **B**)

You've just stored the Expense Report spreadsheet under the name **TEST.CAL**. It's on the disk in drive **B**. SuperCalc adds the suffix **.CAL** automatically when the spreadsheet is stored.

Reloading the Spreadsheet

To use the Expense Report spreadsheet again, you need to load it back into the computer. Follow Steps 5 through 8 at the beginning of this SuperCalc lesson. In Step 7, type **B:TEST** instead of **BRKEVN**.

Always save your spreadsheets on the data disk in drive **B** rather than the SuperCalc disk itself. This will avoid the danger of getting a "disk full" message and losing data.

Printing the Spreadsheet

[/] [O] Output Command

When you're ready to print your Expense Report, first check that your printer is ON and properly connected to the computer.

WHAT YOU DO

38. Type [/] [O]

39. Type [D]

WHAT THE SCREEN DISPLAYS

D(isplay) or C(ontents) report?
/Output,

Enter Range
/Output,Display,

The **range** is the part of the spreadsheet running from the upper left to the lower right corner of the screen. We want to print the Expense Report spreadsheet from **A1** in the upper left to **H21** in the lower right.

WHAT YOU DO

40. Type [A] [1] [:] [H] [2] [1],
then press the [RETURN] key.

41. Type [P] (for Printer).

WHAT THE SCREEN DISPLAYS

Enter Device: P(rinter), S(etup), ...
/Output,Display,A1:H21,

Enter CTRL-Z to STOP print

Your printer should now print the Expense Report you've created. The spreadsheet will remain on screen after it's printed out. You can make changes to it if you wish and print the new versions. When you're ready, you'll store the spreadsheet on disk.

Help!

Printer interface is complex: have your printer hooked up by your dealer to ensure that it runs with SuperCalc. If you have no printer, or the printer won't run, skip to the next step (if the print routine can't be stopped, you may have to remove the disks, turn the computer off and on, and restart SuperCalc.).

Clearing the Screen

Zap Command

After you've stored the data from your Expense Report, the spreadsheet will remain on screen. Here's how to clear the screen and display a new blank spreadsheet.

WHAT YOU DO

45. Type

46. Type (for Yes)

WHAT THE SCREEN DISPLAYS

Y(es) to clear everything, else N(o)
/Zap-ENTIRE-Worksheet?

(Spreadsheet is cleared)

You'll need to clear the screen this way whenever you've stored a spreadsheet and want to start a new one or load one from disk.

Quitting SuperCalc

Quit Command

To exit or QUIT SuperCalc when you've finished:

WHAT YOU DO47. Type 48. Type (for Yes)**WHAT THE SCREEN DISPLAYS**EXIT SuperCalc? Y(es) or N(o)
/Quit,

A> (Screen Clears)

The A> prompt means that you've left SuperCalc. Remove the disks from both drives and store them safely. Then turn the computer OFF.

Ending this Lesson

You've completed your first SuperCalc lesson and learned to create, use, and print a spreadsheet.

SuperCalc has many individual applications, but you've done the basic operations for any of them. That includes: loading a spreadsheet, entering text and numbers, making calculations, then printing and storing the results.

You can go on to the SuperCalc chapter in the *Osborne Executive Guides, Volume 2—Working With Text and Spreadsheets*. It has additional instructions for putting all of SuperCalc's power to work for you.

Or you can continue with the WordStar or Personal Pearl lessons in this *Beginner's Guide*.

Lesson 4: Personal Pearl

What is Personal Pearl?

Personal Pearl is a data management system. You can use it to manage mailing lists, inventory and personnel records, appointment schedules, and many other kinds of business or personal information. With Personal Pearl you can:

- design forms on the screen and store them on disk
- enter and change data on screen and store it on disk
- print forms and reports.

What You Need for This Lesson:

- the Osborne Executive computer
- the **working copy** of the CP/M Plus **System Disk** disk
- the Personal Pearl master disks including the Personal Pearl WELCOME disk
- ten blank disks
- a printer (optional).

In This Lesson You Will:

- make working copies of the Personal Pearl programs using Personal Pearl's copying feature
- enter information and store it on disk
- print reports from the stored information
- change the information you've stored

How To Use This Lesson:

- A. **Complete Lesson 1 before starting this one.** You'll need to use the COPY program described there.
- B. **Review WordStar's editing commands in Lesson 2.** Personal Pearl uses some of these commands.
- C. **Do the numbered steps in sequence.** Don't be afraid to make mistakes. The worst that can happen is that you'll lose some information—that's not serious in this practice lesson.
- D. Watch what happens on screen when you do a step.

This lesson is divided into two sessions. In Session 1 you'll copy the Personal Pearl programs onto formatted disks. In Session 2, you'll use PEARL (short for Personal Pearl) to enter, change, and print data.

Session 1: Getting Started

In this session you'll copy the Personal Pearl disks and prepare the copies for use. This process is simple, but it takes a bit of time. You only need to do it once, then the copies will be ready to use.

Once you start preparing the disks, you'll find it easier have to complete the entire sequence at one sitting. So, **please set aside about an hour for this session.**

First, **remove** any disks from the Osborne Executive's disk drives. If the computer is ON, press the RESET button on the front of the machine. If the computer isn't ON, turn it ON now.

Using CP/M Plus To Copy Personal Pearl

1. Insert the **working copy** of the CP/M Plus **System Disk** in drive **A**.
 2. Insert a **formatted blank disk** in drive **B**. (Formatting instructions are contained in *Lesson 1 — Setup and CP/M Plus*.)
-

WHAT YOU DO

3. Press **RETURN**.

Type **COPYSYS**.

WHAT THE SCREEN DISPLAYS

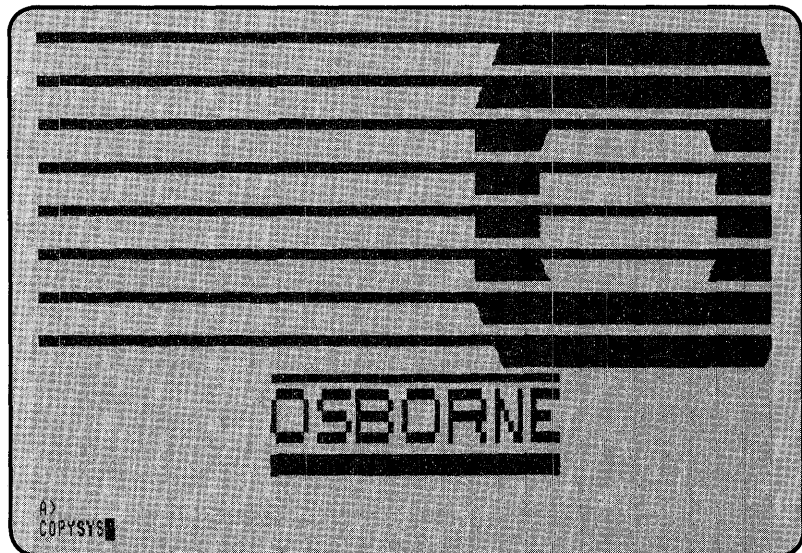

Help!

*If you make a typing error, press the **left arrow key** to backspace the cursor over it. Then type the correction.*

COPYSYS is the program that places CP/M Plus onto disks. You'll need it on **each** of the ten working blank disks that you are creating.

WHAT YOU DO

4. Press **RETURN**.

WHAT THE SCREEN DISPLAYS

Operating System Copy Program
Osborne EXECUTIVE Computer System
V1.1

■ Get System from Drive A
Get System from Drive B
Return to CP/M

Use the **ARROW KEYS** to position the cursor next to the desired choice.

or

Insert diskette in Drive A and
Press **RETURN** to **READ SYSTEM**

Copyright (c) 1983 Osborne Computer Corporation,
26538 Danti Court, Hayward, CA 94545.

WHAT YOU DO

5. Press **RETURN** to copy the system from drive **A**.

WHAT THE SCREEN DISPLAYS

Operating System Copy Program
Osborne EXECUTIVE Computer System
V1.1

Get System from Drive A
Get System from Drive B
Return to CP/M

System read successfully.

Press **RETURN** to select save option. ■

WHAT YOU DO

6. Press .

WHAT THE SCREEN DISPLAYS

Operating System Copy Program
Osborne EXECUTIVE Computer System
V1.1

Save System on Drive A
 Save System on Drive B
Return to CP/M

Use the ARROW KEYS to position the
cursor next to the desired choice.

or
Insert diskette in Drive B and
Press RETURN to SAVE SYSTEM

WHAT YOU DO

7. Press .

WHAT THE SCREEN DISPLAYS

Operating System Copy Program
Osborne EXECUTIVE Computer System
V1.1

Save System on Drive A
Save System on Drive B
Return to CP/M

System copied successfully.
Press RETURN to continue.

Help!

The following message may appear on your screen:

**CPM3.SYS is already on drive B.
Do you want to overwrite it (y/n)?**

*It indicates that the diskette in drive **B** already contains the
CP/M Plus Operating System. If this message appears, simply
press to continue.*

WHAT YOU DO

8. Press **RETURN**.

WHAT THE SCREEN DISPLAYS

Operating System Copy Program
Osborne EXECUTIVE Computer System
V1.1

Save System on Drive A
■ Save System on Drive B
Return to CP/M

Use the **ARROW KEYS** to position the
cursor next to the desired choice.

or
Insert diskette in Drive B and
Press **RETURN** to **SAVE SYSTEM**

WHAT YOU DO

9. Press the **down arrow key**
to select the "Return to
CP/M" option.

10. Press **RETURN**.

WHAT THE SCREEN DISPLAYS

A>

WHAT YOU DO

11. Type **COPY**.
12. Press **RETURN**.

WHAT THE SCREEN DISPLAYS

Disk Utility Program
Osborne EXECUTIVE Computer System
V1.1

■ Copy Diskettes
Format Diskettes
RETURN TO CP/M

Use the **ARROW** keys to position the
cursor next to the desired choice
or

Press **RETURN** to select a **COPY** option

Copyright (c) 1983 Osborne Computer Corporation,
26538 Danti Court, Hayward, CA 94545.

13. Remove the CP/M Plus Systems diskette from drive **A** and replace it with the diskette from drive **B** onto which you just copied the CP/M Plus Operating System.
14. Place a blank diskette in drive **B**. In the following steps, you're going to make 9 copies of the diskette in drive **A**. As a result, you'll have 10 formatted diskettes, all with system tracks. These will be used in the next section to make copies of your Personal Pearl master diskettes.

WHAT YOU DO

15. Press **RETURN** to select the "Copy Diskettes" option.

WHAT THE SCREEN DISPLAYS

```

Disk Utility Program
Osborne EXECUTIVE Computer System
Rev X3.056 (c) 1983 OCC
    
```

- █ Copy from Drive A to Drive B
- Copy from Drive B to Drive A
- Return to the Main Menu
- Return to CP/M

```

Use the ARROW keys to position the
cursor next to the desired choice
or
Insert Diskettes and
Press RETURN to COPY
    
```

Copyright (c) 1983 Osborne Computer Corporation,
26538 Danti Court, Hayward, CA 94545.

WHAT YOU DO

16. Press **RETURN** to copy from drive **A** to drive **B**.

WHAT THE SCREEN DISPLAYS

Disk Utility Program
Osborne EXECUTIVE Computer System
Rev X3.056 (c) 1983 OCC

Copy from Drive A to Drive B
Copy from Drive B to Drive A
Return to the Main Menu
Return to CP/M

Press Q to Quit Copying

Reading/Writing Tracks 1-39

COPY completed successfully.
Press RETURN to continue. ■

Warning!

The following message may appear on your screen:

**Diskette in Drive B contains information.
Is it OK to overwrite (y/n)?**

*It indicates that information is stored on the diskette in drive B.
Make sure that the diskette in drive B does not contain
information that you want to keep, then press to continue.*

Help!

Under certain conditions an error may be encountered during the copy process and the following message is displayed:

COPY ERROR

If this message appears, try copying the diskette a second time. If the error occurs again, you will have to use another diskette in drive B.

WHAT YOU DO

17. Press **RETURN** to continue.

WHAT THE SCREEN DISPLAYS

Disk Utility Program
Osborne EXECUTIVE Computer System
Rev X3.056 (c) 1983 OCC

- Copy from Drive A to Drive B
- Copy from Drive B to Drive A
- Return to the Main Menu
- Return to CP/M

Use the ARROW keys to position the cursor next to the desired choice
or

Insert Diskettes and
Press RETURN to COPY

18. Remove the diskette from drive **B**, replace it with another blank diskette, and repeat steps 16 through 18 until you have copied the CP/M Plus Operating System to all ten diskettes. Each diskette is formatted automatically during this process. When you are through, follow step 19 below to leave the COPY program.

WHAT YOU DO

19. Press the **down arrow key** until the cursor is next to the "Return to CP/M" option, and then press **RETURN**.

WHAT THE SCREEN DISPLAYS

A>

Using Personal Pearl To Copy Programs

While you may have used the CP/M Plus COPY utility to copy other master diskettes, the *only* way you can copy Personal Pearl's programs correctly is with the personalizing program on the Personal Pearl WELCOME diskette.

Remove the CP/M Plus diskette from drive A and put Personal Pearl's WELCOME diskette in its place (labeled "WELCOME DISK, 1st MASTER DISK").

WHAT YOU DO

1. Type `WELCOME` at the A> prompt.
2. Press `RETURN`.

WHAT THE SCREEN DISPLAYS

```

Welcome to Personal Computing.

Welcome to data base management using PERSONAL PEARL.

WELCOME SERVICES

Demonstration will take you through a demonstration of PERSONAL PEARL
to familiarize you with the services provided by PERSONAL PEARL.
It will also provide a description of the Starter Library.

Personalize will get you underway by setting up your PERSONAL PEARL
working disks and personalize them for your own private use. You
will also be able to verify the integrity of your copy of
PERSONAL PEARL and have the capability to change over to another
terminal sometime later.

----- WELCOME SELECTION -----
ENTER YOUR SELECTION (D or P) █

Press ESC to EXIT to CP/M.

Welcome Disk, (c) 1982 by PEARLSOFT, All rights reserved.
```

Help!

*If you make a typing error, press the **left arrow key** to backspace the cursor over it. Then type over your mistake.*

This menu gives you a choice between a demonstration of how Personal Pearl works and the Personalize program. As always with Personal Pearl, the cursor is where you need to enter information. Right now the cursor is on the question line:

ENTER YOUR SELECTION (D or P) █

You may want a demonstration right now, but it is important to get your working diskettes set up before you do anything else.

We'll select P (for Personalize) because that is the program you need to use to copy the master diskettes.

WHAT YOU DO

3. Press **P**.
4. Press **RETURN**.

WHAT THE SCREEN DISPLAYS

Step 1: Make Working Copies

Step 2: Personalize Your Working Copy

Optional Step 3: Verify Program Files

Optional Step 4: Change Terminal of System Configuration

----- GETTING UNDERWAY -----

ENTER A STEP NUMBER █

Press ESC to EXIT

WHAT YOU DO

5. Press **1**.
6. Press **RETURN**.

WHAT THE SCREEN DISPLAYS

SET UP WORKING COPY OF MASTER DISKETTES

Your PERSONAL PEARL system is provided on six MASTER diskettes. You may configure your working system to use one of the following configurations:

	configurations	disk capacity	diskettes required
1.	standard	160 K	10
2.	hard disk		

Please enter your selection. █

PEARL is asking you to specify your system configuration to determine how many diskettes you will need. The "standard" configuration is usually used for the Osborne Executive, unless you have a hard disk.

WHAT YOU DO

7. Press **1**.
8. Press **RETURN**.

WHAT THE SCREEN DISPLAYS

Before making working copies, be sure that the diskettes you are going to use for PEARL are formatted, and that you have placed a copy of the CP/M operating system on each diskette. The procedure used to format and place a copy of CP/M varies from one computer to another. If you are not sure of the procedure for your computer, refer to your user manual or contact your dealer for support.

■

Press RETURN to continue

WHAT YOU DO

9. Press **RETURN**.

WHAT THE SCREEN DISPLAYS

Label each of your working diskettes as follows:

1. WELCOME
2. STARTER LIBRARY-CALENDR programs
3. STARTER LIBRARY-PEOPLE programs
4. STARTER LIBRARY-CASH programs
5. SORT
6. DESIGN REPORTS
7. DESIGN FORMS
8. FILE MAINTENANCE
9. ENTER DATA
10. PRODUCE REPORTS

Press ESC to EXIT, or RETURN to continue making your working copies. ■

PEARL is asking you to label your working diskettes as shown on the screen. You should stop and do that now.

Help!

This message is at the bottom of several screens you've seen:

PRESS ESC to EXIT

You can leave Personal Pearl at almost any time by pressing ESC once or several times. ESC returns you to previous screens within a program until finally you exit to CP/M Plus. At this point you'll see the A> prompt on the screen.

After you have labeled your working diskettes, continue to the next step.

WHAT YOU DO

10. Press **RETURN**.

WHAT THE SCREEN DISPLAYS

As each file is copied, the message 'verified' or 'copy successful' should appear. If the message 'file not found' or 'verify error' appears, this indicates that you have a defective MASTER disk. In this case, contact your dealer and ask for a replacement.

The SOURCE drive for the copy operation will always be the logged in drive (normally drive A). You will be requested to place your MASTER diskettes on this drive.

The DESTINATION drive may be any drive on your system. If you are using a standard configuration, this will be drive B.

ENTER DESTINATION DRIVE █

PEARL has to know into which drive you are going to insert the destination diskettes (diskettes onto which you will copy the programs).

WHAT YOU DO

11. Place the **working copy** of the WELCOME diskette in drive **B**. This is the diskette you just labeled "1.WELCOME".

12. Press **[B]**.

13. Press **[RETURN]**.

WHAT THE SCREEN DISPLAYS

The screen periodically displays instructions about when to insert new working copy diskettes and master diskettes.

PEARL now instructs you when to place each labelled working (destination) diskette in drive **B** and when to place each master diskette in drive **A**.

The copying process proceeds. Change diskettes whenever an instruction to do so appears on the screen. Bear in mind that the new working copy diskettes always go in drive **B** and the master diskettes go in drive **A**.

Warning:

*If an error occurs while you are copying the master diskettes, you **must** begin the entire process from the beginning.*

When you have successfully copied all your master diskettes onto your working copy diskettes, continue to step 14.

WHAT TO DO

14. Place your first master diskette (WELCOME) in drive **A**.

15. Press **[RETURN]**.

WHAT THE SCREEN DISPLAYS

If all of the files were copied successfully, you should now place your MASTER DISKETTES in a place for safe keeping as you should save them purely for backup copies (in case you spill coffee on your working diskettes).

In order to use the working copy of your PERSONAL PEARL system, proceed as follows:

1. Place your WORKING copy of the WELCOME disk in the logged-in drive (this will normally be drive A) or if you have placed PERSONAL PEARL on your hard disk, log on to the drive which contains the PERSONAL PEARL programs.
2. Enter WELCOME and press RETURN.
3. Select 'Personalize' on the first WELCOME selection screen.
4. Select Step 2 on the following menu, GETTING UNDERWAY, to personalize your working copy of PERSONAL PEARL. ■

Press RETURN to continue

-
16. Remove your diskettes from both disk drives and put your master diskettes in a safe, cool, dry place. From this point on, you will use only your ten working diskettes for Personal Pearl.
 17. Press the RESET button on the front of your Osborne Executive, insert the WELCOME diskette in drive A, and press **RETURN**. You are now ready to personalize your Personal Pearl diskettes.

Personalizing Your Disks

Now you can personalize several of your diskettes. The personalization tells to whom your copy of Personal Pearl has been licensed.

You are back at the WELCOME menu. We'll need to use the Personalize program again.

WHAT YOU DO

1. After the A> prompt appears, type **W E L C O M E**.
2. Press **RETURN**.

WHAT THE SCREEN DISPLAYS

```

Welcome to Personal Computing.

Welcome to data base management using PERSONAL PEARL.

WELCOME SERVICES

Demonstration will take you through a demonstration of PERSONAL PEARL
to familiarize you with the services provided by PERSONAL PEARL.
It will also provide a description of the Starter Library.

Personalize will get you underway by setting up your PERSONAL PEARL
working disks and personalize them for your own private use. You
will also be able to verify the integrity of your copy of
PERSONAL PEARL and have the capability to change over to another
terminal sometime later.

----- WELCOME SELECTION -----
ENTER YOUR SELECTION (D or P) █

Press ESC to EXIT to CP/M.

Welcome Disk, (c) 1982 by PEARLSOFT, All rights reserved.
```

WHAT YOU DO

3. Press **P**.
 4. Press **RETURN**.
-

WHAT THE SCREEN DISPLAYS

Step 1: Make Working Copies

Step 2: Personalize Your Working Copy

Optional Step 3: Verify Program Files

Optional Step 4: Change Terminal of System Configuration

----- GETTING UNDERWAY -----

ENTER A STEP NUMBER █

Press ESC to EXIT

WHAT TO DO

5. Press **2**.

6. Press **RETURN**.

7. Read the message on the screen and Press **RETURN**.

WHAT THE SCREEN DISPLAYS

In order to personalize PERSONAL PEARL, you must have used option 1 on the WELCOME MENU to create a working copy of your system. If you have done this, press RETURN to continue. If not, press ESCAPE to return to the WELCOME MENU.

PERSONAL PEARL SYSTEM CONFIGURATION

The TPA size on your system is 62,212 or 60.7 K.

The Transient Program Area (TPA) size is the amount of memory available in your computer to run programs.

In order to use PERSONAL PEARL we recommend a 51K TPA.

Insert DESIGN FORMS disk in drive: A
Then press RETURN to continue. █

WHAT YOU DO

8. Insert the requested working diskette.
9. Press **RETURN**.

WHAT THE SCREEN DISPLAYS

```
PROCESSING - PEARLDF.COM

Enter USER NAME _____

*****
Last chance to verify or change user name
*****

USER NAME is set as:

Is the current value OK? (Y/N) █
```

-
10. When you are asked to "Enter USER NAME", enter the name of the company or person to whom your diskettes have been licensed. The system will give you a chance to change your mind and enter another name if you made an error. Once you tell the system to accept the name you've entered, it will give you instructions for personalizing other diskettes.

Continue to follow the directions on the screen until all the requested diskettes are personalized. (Not all diskettes will be personalized.)

Session 2: Using Personal Pearl

Personal Pearl's Demonstration Program

The WELCOME diskette contains a demonstration of how PEARL works. If you wish to see this demonstration right now, continue reading this section. If you want to start using Personal Pearl immediately, skip to the next section. You can come back to the demonstration later.

To see PEARL demonstrated, put the WELCOME diskette in drive A and press **[RETURN]**. Type **W E L C O M E** and a **[RETURN]**. When the Demonstration/Personalize screen is displayed, select **[D]** and press **[RETURN]**.

Now PEARL lets you watch as an imaginary person designs a form and reports, enters data, and prepares a report for display. An explanation of what is happening appears on each screen display. Simply press **[RETURN]** again and again to move through the demonstration.

The Starter Library

Personal Pearl includes a Starter Library that consists of three programs:

- an appointment calendar named CALENDR,
- a people information form named PEOPLE, and
- a cash disbursement journal named CASH.

These programs are on your second, third and fourth working diskettes. When you use one of these programs, you do not have to design a form or the reports that go with it. PEARL has predesigned them for you already. All you have to do is enter information and produce the reports.

The remainder of this session will be devoted to showing you how to use Personal Pearl with the CALENDR program from the Starter Library.

Preparing To Enter Information

We are going to prepare to use PEARL's CALENDR program from the Starter Library and the ENTER DATA diskette to enter appointment information on a predesigned form.

Follow the instructions below:

1. Push the RESET button on the front of the machine.
2. Insert the ENTER DATA diskette in drive A.
3. Insert the STARTER LIBRARY—CALENDR diskette in drive B.
3. Press **RETURN**.

Now you will enter PEARL's Edit Data program.

WHAT YOU DO

5. When the A> prompt appears, type **P E A R L E D**.
6. Press **RETURN**.

WHAT THE SCREEN DISPLAYS

```

                P E R S O N A L   P E A R L
                Copyright 1982 by PEARLSOFT
                All rights reserved

0000000  000  00  00000000  0000000  0000000
00      0000 00      00      00      00  00
0000    00 00 00      00      0000    0000000
00      00 0000      00      00      00  00
0000000  00  000      00      0000000  00  00

                0000000      0000      00000000      0000
00  00  00  00      00      00  00
00  00  00000000      00      00000000
00  00  00  00      00      00  00
0000000  00  00      00      00  00

```

LICENSED EXCLUSIVELY TO:

YOUR SERIAL NUMBER IS:

Press RETURN to continue, ? for HELP, or ESC to EXIT █

Your personalization information appears on the screen.

Help!

The message line at the bottom of the screen says:

Press RETURN to continue, ? for HELP, or ESC to EXIT

If you press RETURN you will go to the next step in the program—a new screen display. In almost all cases, pressing RETURN steps you through a program and moves you from screen to screen in a predetermined sequence.

Help!

PEARL provides you with on-line help. Any time you type a question mark (?) or CTRL-Q you will receive an explanation concerning the display that is currently on your screen. To leave HELP, press RETURN. If you wish, get HELP right now by pressing ? and then return to the screen you are on by pressing RETURN.

Press ESC to return to the previous screen, or press ESC repeatedly to leave Personal Pearl.

We proceed to the Form Directory which tells you which forms are on your CALENDR program diskette.

WHAT YOU DO

7. Press **RETURN**.

WHAT THE SCREEN DISPLAYS

FORM	DESCRIPTION
CALENDR	APPOINTMENT CALENDAR

----- FORM DIRECTORY -----

GIVE PEARL YOUR NEW OR PREVIOUSLY DEFINED FORM NAME:

Press RETURN to continue, ? for HELP, or ESC to EXIT

Right now this form directory has only one form in it, CALENDR. As you learn more about PEARL, you will add other forms.

Entering information on a form is the way you place information into a file associated with that form. The file is stored on the diskette in drive B. So now, we are going to tell PEARL which form we want to use.

WHAT YOU DO

8. Type **C A L E N D R**.

9. Press **RETURN**.

WHAT THE SCREEN DISPLAYS

```

APPOINTMENT CALENDAR =====( PEARL Starter Library )

DATE: █ _____ ( format dates mm/dd/yy or mm dd yy )
TIME: ____ _ (AM/PM) ( format times hh.mm AM or hh.mm PM )
PERSON: _____
PURPOSE: _____
DIARY:
_____
_____
_____

----- ENTER DATA - CONTROL KEY COMMANDS -----
U - Save/Replace record   B - Switch ADD/EDIT   Z - Get next record
N - Duplicate last item   E - Move cursor up   W - Get previous record
P - Print current record  X - Move cursor down  O - Delete current record
Q - HELP                  I - Tab forward      ESC - EXIT

ADD

```

This is the CALENDR input form. We'll use it to enter our appointment information.

The lower left corner of the screen says ADD. That means that you can enter information on the form right now.

Help!

The bottom of the screen tells you which control keys are valid with this screen. The keys that you will need right now are:

***CTRL-U** stores the information (record) you have entered on the form.*

***CTRL-Q** displays HELP information associated with this screen. Press RETURN to return to the form.*

***CTRL-E** moves the cursor into the data area above.*

***CTRL-X** moves the cursor into the data area below.*

Some other keys you need to know about are:

***TAB** moves the cursor to the beginning of the next data area.*

***RETURN** moves the cursor to the beginning of the next data area.*

***ESC** returns you to the previous screen.*

Entering Information on the Form

The CALENDR form contains five data areas. You *must* enter information in the first four data areas. PEARL will only store the record (the entire set of information on the screen) if you have filled in these data areas. The last area is optional.

When you are finished entering information in a data area, move to the next area by pressing RETURN, TAB, or CTRL-X. If you fill a data area entirely, the system will automatically move you to the next area. If you make a typographical error, use CTRL-E, CTRL-X, and the arrow keys to find and correct the error.

The cursor is at DATE. The screen should look like the one below when you are finished entering your data. Below the screen, we explain the rules for entering data into each data area.

WHAT YOU DO

1. Enter appointment information.

WHAT THE SCREEN DISPLAYS

APPOINTMENT CALENDAR =====(PEARL Starter Library)

DATE: 4/15/83 (format dates mm/dd/yy or mm dd yy)

TIME: 10.30 AM (AM/PM) (format times hh.mm AM or hh.mm PM)

PERSON: ACME TILE CO. - J. JONES_____

PURPOSE: DEMONSTRATION_____

DIARY:

BRING MODEL A AND MODEL B FOR DEMONSTRATION.█_____

----- ENTER DATA - CONTROL KEY COMMANDS -----

U - Save/Replace record	B - Switch ADD/EDIT	Z - Get next record
N - Duplicate last item	E - Move cursor up	W - Get previous record
P - Print current record	X - Move cursor down	O - Delete current record
Q - HELP	I - Tab forward	ESC - EXIT

ADD

DATE: (Required) This area is indexed; i.e., you can use it to look up individual calendar records and to produce chronological reports. You can use any format you like (2/6/83, 2-6-83, 020683), provided that you always enter the month first, then the day, then the year.

TIME: (Required) Unlike the DATE area, there is only *one* acceptable way to enter the TIME — exactly as shown above. A period separates the hour and minutes (a colon won't work), and then there is a space followed by a capitalized AM or PM.

PERSON: (Required) You can enter a person's or company's name here. Because this data area is indexed, you can use it to report on all appointments with a particular person or company.

PURPOSE: (Required) This area lets you record the purpose of the appointment. This area is indexed just like PERSON and DATE. You can see that there might be several ways to use this data area. For example, you could enter CLIENT or LUNCH. When you want to find out what your luncheon or sales or client appointment schedule is for the next week, you will have a key to let CALENDR know which appointment records you want to see.

DIARY: (Optional) You can enter up to three lines of information in this data area. Not only can you enter information before the appointment, you can edit it after the appointment to record the result of the meeting. That way, CALENDR can be even more useful to you.

Now that the form is filled in you need to save the information in the appointment calendar on the diskette in drive B. When you have saved the entry, the message RECORD ADDED appears at the lower right of your screen.

2. Type **CTRL U** to save the record. A new blank screen will appear to allow you to add more records. Enter two more records as shown below exactly the way you added the first record.

WHAT YOU DO

3. Enter information for the second appointment and type **CTRL U**.

WHAT THE SCREEN DISPLAYS

APPOINTMENT CALENDAR -----(PEARL Starter Library)

DATE: 4/15/83 (format dates mm/dd/yy or mm dd yy)

TIME: 2.00 PM (AM/PM) (format times hh.mm AM or hh.mm PM)

PERSON: STAR INDUSTRIES - B. SMITH_____

PURPOSE: SIGN SALES ORDER_____

DIARY:

BRING BOTH A RENTAL AND A LEASE AGREEMENT SO BILL CAN DECIDE
WHICH HE WANTS TO USE. _____

----- ENTER DATA - CONTROL KEY COMMANDS -----

U - Save/Replace record	B - Switch ADD/EDIT	Z - Get next record
N - Duplicate last item	E - Move cursor up	W - Get previous record
P - Print current record	X - Move cursor down	O - Delete current record
Q - HELP	I - Tab forward	ESC - EXIT

ADD 183 K

WHAT YOU DO

4. Enter information for the third appointment and type **CTRL U**.

WHAT THE SCREEN DISPLAYS

```

APPOINTMENT CALENDAR -----( PEARL Starter Library )

DATE: 4/13/83          ( format dates mm/dd/yy or mm dd yy )

TIME: 9.30 AM (AM/PM)  ( format times hh.mm AM or hh.mm PM )

PERSON: STANLEY PRODUCTS - L. STANLEY_

PURPOSE: INITIAL VISIT_____

DIARY:

BRING SALES LITERATURE AND PRICE SHEET - WANTS TO SEE_____
QUANTITY DISCOUNTS, TOO. _____
█_____

----- ENTER DATA - CONTROL KEY COMMANDS -----

U - Save/Replace record   B - Switch ADD/EDIT   Z - Get next record
N - Duplicate last item   E - Move cursor up   W - Get previous record
P - Print current record  X - Move cursor down O - Delete current record
Q - HELP                  I - Tab forward     ESC - EXIT

ADD          183 K
    
```

You now have three records stored in your appointment calendar file on the diskette in drive B.

Now we will leave the CALENDR form and return to the Form Directory.

WHAT YOU DO

5. Press **[ESC]**.

WHAT THE SCREEN DISPLAYS

EXIT?

WHAT YOU DO

6. Press **[Y]**.

WHAT THE SCREEN DISPLAYS

FORM	DESCRIPTION
CALENDR	APPOINTMENT CALENDAR

----- FORM DIRECTORY -----

GIVE PEARL YOUR NEW OR PREVIOUSLY DEFINED FORM NAME: █ _____

Press RETURN to continue, ? for HELP, or ESC to EXIT

You now have three choices: You can press ESC one more time and PEARL will display the Service Directory. You can press ESC enough times to bring you back to CP/M Plus and turn off the Executive. Or, if you want to produce a report right now, you can continue to step 7.

WHAT YOU DO

7. Press **[ESC]**.

WHAT THE SCREEN DISPLAYS

```
Service 1: ENTER DATA

Service 2: PRODUCE REPORTS

----- SERVICE DIRECTORY -----

ENTER A SERVICE NUMBER: █

Press RETURN to continue, ? for HELP, or ESC to EXIT
```

The Service Directory gives you a choice of entering data or producing a report. We've already entered data, so we want to produce a report.

WHAT YOU DO

8. Press **2**.
9. Press **RETURN**.

WHAT THE SCREEN DISPLAYS

```
Place PRODUCE REPORTS program disk on drive A.
Then press RETURN, OR,
press ESCAPE, to terminate request.

█
```

Producing Reports

PEARL produces reports from information you have entered on the video screen form and then stored on a diskette. We will use two of the predesigned reports that come with CALENDR. First we'll produce an appointment calendar that shows all the appointment records that you have stored. Then we'll select a specific record by specifying a range of dates into which the displayed record must fall.

CALENDR has three reports. PEARL designed these reports for you because they are the most common and useful types for appointment calendars.

1. The DAILY APPOINTMENT CALENDAR is a chronological summary of scheduled events. It contains all information you entered except the DIARY information.
2. The DIARY REPORT is just like the DAILY APPOINTMENT CALENDAR except that it also contains the DIARY entry.
3. The HISTORY REPORT is a log of contacts with people. It shows the stored information grouped by PERSON in chronological order for each person (or company if you entered company names).

During report production, you will be asked to change diskettes. You will have to replace the Produce Reports diskette with the SORT diskette for a minute or two. PEARL tells you exactly when to do this. Be careful, however, that you do not change diskettes until the disk drive has stopped running.

If you have come directly from step 9 in the previous section, go directly to step 1 below.

If the machine has been turned off, turn it on and insert the Produce Reports diskette in drive **A** and the CALENDR diskette in drive **B**. Press **RETURN** and then enter **P E A R L P R** at the **A>** prompt. Follow the directions on the screen until you reach the CALENDR Report Directory. Start at step 3 below.

WHAT YOU DO

1. Insert the Produce Reports diskette in drive **A**.
2. Press **RETURN**.

WHAT THE SCREEN DISPLAYS

REPORT	DESCRIPTION
DAILY	DAILY APPOINTMENT CALENDAR
DIARY	PERSONAL DIARY
HISTORY	HISTORY OF PEOPLE CONTACTS

----- REPORT DIRECTORY -----

Form Name: CALENDR
 GIVE PEARL THE NAME OF THE REPORT: █ _____

Press RETURN to continue, ? for HELP, or ESC to EXIT

Three reports names — **DAILY**, **DIARY**, and **HISTORY** — are displayed along with a brief description of each report. You choose a report by entering its name.

We are going to want to produce the Daily Appointment Calendar.

WHAT YOU DO

3. Type **DAILY**.

4. Press **RETURN**.

WHAT THE SCREEN DISPLAYS

Optional Step 1: SELECTION VALUES

Optional Step 2: PRINTOUT DETAILS

Step 3: FINAL REPORT

----- PRODUCE REPORTS -----

Form Name: CALENDR

Report Name: DAILY

ENTER A STEP NUMBER: █

Press RETURN to continue, ? for HELP, or ESC to EXIT

Optional Step 1 lets you enter top and bottom values for DATE, PERSON, and PURPOSE. PEARL then prints only the records that fall within those values.

Optional Step 2 lets you give the report a name and specify how the report is to be printed or displayed on the screen.

Step 3 lets you print the report.

We want to see *all* the appointment records, so we'll skip step 1 on the screen and go directly to step 2.

WHAT YOU DO

5. Press **2**.
6. Press **RETURN**.

WHAT THE SCREEN DISPLAYS

```
TITLE: █ _____
NUMBER OF REPORT LINES PER PAGE  58_
TOTAL LINES PER PAGE              0_   (0 = use form feed)
FILE NAME FOR REPORT _____ (blank - printer, CON: - Console )
MULTIPLE FORMS ON ONE PAGE:      (Fixed reports only)
NUMBER OF FORMS ACROSS: NA      SINGLE FORM WIDTH: NA_ (columns)

----- PRINTOUT DETAILS -----

Form Name:  CALENDR              Report Name:  DAILY

You may make changes above by typing a new value.

Press RETURN to continue, ? for HELP, or ESC to EXIT
```

This form tells PEARL how to print the DAILY report. Notice that the name of the form and the report name are listed under **PRINTOUT DETAILS**. Whatever you enter for this specific report remains the same until you change it. That means that you do not have to use this option every time you print this report.

Fill in this form using the same method you used for filling in the CALENDR form. If you have a printer with automatic form feed, that prints 6 lines per inch, and is using 8-1/2-by-11-inch paper (the most common situation), fill in the form as shown in step 7. If you have no printer right now and what to display the report on your screen, fill in the form as shown in step 8.

An explanation about filling in each data area appears below the two screens shown.

WHAT YOU DO

7. Fill in the **Printout Details** screen for a standard printer.

WHAT THE SCREEN DISPLAYS

```

TITLE:  DAILY CALENDAR FOR WEEK OF 4/11/83_____

NUMBER OF REPORT LINES PER PAGE  55_

TOTAL LINES PER PAGE              66_   (0 = use form feed)

FILE NAME FOR REPORT  _____   (blank - printer, CON: - Console )

MULTIPLE FORMS ON ONE PAGE:      (Fixed reports only)
NUMBER OF FORMS ACROSS: NA      SINGLE FORM WIDTH: NA_ (columns)

----- PRINTOUT DETAILS -----

Form Name:  CALENDR              Report Name:  DAILY

You may make changes above by typing a new value.

Press RETURN to continue, ? for HELP, or ESC to EXIT

```

WHAT YOU DO

8. Alternatively, fill in the **Printout Details** screen for a screen display.

WHAT THE SCREEN DISPLAYS

```

TITLE:  DAILY CALENDAR FOR WEEK OF 4/11/83_____

NUMBER OF REPORT LINES PER PAGE  20_

TOTAL LINES PER PAGE              24_  (0 = use form feed)

FILE NAME FOR REPORT  CON:_____  (blank - printer, CON: - Console )

MULTIPLE FORMS ON ONE PAGE:      (Fixed reports only)
NUMBER OF FORMS ACROSS: NA      SINGLE FORM WIDTH: NA_ (columns)

----- PRINTOUT DETAILS -----

Form Name:  CALENDR              Report Name:  DAILY

You may make changes above by typing a new value.

Press RETURN to continue, ? for HELP, or ESC to EXIT

```

TITLE: This is the title that will appear at the top of each page of the report.

NUMBER OF REPORT LINES PER PAGE: This is the number of lines (including blank lines) that will be printed before the paper moves to the next page. If you don't have a printer yet, enter for displaying the report on the screen. Your screen displays 24 lines, but we want to leave the bottom four lines for messages and instructions from PEARL.

TOTAL LINES PER PAGE: This is the total number of lines you could get onto the page if every line were printed from top to bottom. Enter if your printer has automatic form feed. If it does not, enter . Press . If you don't have a printer, type which is the number of lines on your video screen.

FILE NAME FOR REPORT: Pressing RETURN with no entry tells PEARL that the report is to be printed on the printer. To display the report on the screen instead of printing it, type and press .

You are now finished with the printout details. The rest of the lines on the screen are irrelevant to this report.

Now you're ready to print your appointment calendar (or display it on the screen).

9. If you're going to print your report, turn on the printer and adjust the paper.
10. Type and on the Produce Reports menu, and report generation begins.

Remember that PEARL will ask you to insert the SORT diskette in drive A at some point before the report is produced. Then you will be asked to reinsert the Produce Reports diskette.

We have decided to display the final report on the screen. This is the report you should have:

DAILY CALENDAR -----(PEARL Starter Library			
DATE	TIME	PERSON	PURPOSE
4/13/83	9.30 AM	STANLEY PRODUCTS - L. STANLE	INITIAL VISIT
***** 1 APPOINTMENTS ON 4/13/83 *****			
4/15/83	10.30 AM	ACME TILE CO. - J. JONES	DEMONSTRATION
4/15/83	2.00 PM	STAR INDUSTRIES - B. SMITH .	SIGN SALES ORDER
***** 2 APPOINTMENTS ON 4/15/83 *****			
			----- Page 1 -----
			Press RETURN ?

When the report is finished, press **RETURN**, and the Report Directory is again displayed.

Now let's suppose that you cannot remember what you are supposed to talk to J. Jones or B. Smith about. The best way to find out is to display the DIARY report, specifying the earliest and latest dates to be included in the report.

1. Type DIARY on the Report Directory menu. PEARL displays the Produce Reports menu.

This time you are going to want to limit the number of records displayed, so you will select Optional Step 1: SELECTION VALUES.

WHAT YOU DO

2. Press **1**.
3. Press **RETURN**.

WHAT THE SCREEN DISPLAYS

APPOINTMENT CALENDAR -----(PEARL Starter Library)

DATE: █ _____ (format dates mm/dd/yy or mm dd yy)

TIME: ____ (AM/PM) (format times hh.mm AM or hh.mm PM)

PERSON: _____

PURPOSE: _____

DIARY:

ENTER LOW SELECTION VALUES

This is the same form that you used to enter your information. You use it for a different purpose, however. At the lower left on the screen it says:

ENTER LOW SELECTION VALUES

You enter data in an indexed data area that tells PEARL to select only records that contain information with this value or a higher value.

WHAT YOU DO

4. Type .
5. Press .
6. Press .

WHAT THE SCREEN DISPLAYS

EDITS COMPLETE?

WHAT YOU DO

7. Press **[Y]**.

WHAT THE SCREEN DISPLAYS

APPOINTMENT CALENDAR =====(PEARL Starter Library)

DATE: █ _____ (format dates mm/dd/yy or mm dd yy)

TIME: ____ _ (AM/PM) (format times hh.mm AM or hh.mm PM)

PERSON: _____

PURPOSE: _____

DIARY:

ENTER HIGH SELECTION VALUES

Now you have a blank form again. At the bottom it says:

ENTER HIGH SELECTION VALUES

You enter data in same indexed data area (DATE) as you did above to tell PEARL to select only records that contain information with this value or lower.

WHAT YOU DO**WHAT THE SCREEN DISPLAYS**

8. Type .

9. Press .

10. Press .

EDITS COMPLETE?

11. Press .

WHAT THE SCREEN DISPLAYS

Optional Step 1: SELECTION VALUES

Optional Step 2: PRINTOUT DETAILS

Step 3: FINAL REPORT

----- PRODUCE REPORTS -----

Form Name: CALENDR

Report Name: DIARY

ENTER A STEP NUMBER: █

Press RETURN to continue, ? for HELP, or ESC to EXIT

12. Select Optional Step 2 and enter the same values you entered for the DAILY report. Press to again return to the Produce Reports menu.
13. When you're returned to the Produce Reports menu, press and to generate the report, as shown below.

DATE	TIME	PERSON	PURPOSE
4/15/83	10.30 AM	ACME TILE CO. - J. JONES	DEMONSTRATION BRING MODEL A AND MODEL B FOR DEMONSTRATION
4/15/83	2.00 PM	STAR INDUSTRIES - B. SMITH	SIGN SALES ORDER BRING BOTH A RENTAL AND A LEASE AGREEMENT SO BILL CAN DECIDE WHICH HE WANTS TO USE.

----- Page 1 -----

Press RETURN ?

When the report is finished, press **RETURN** to return to the Report Directory.

14. Press **ESC** twice to return to the Service Directory.

Editing Stored Information

You can change the information you have stored. You can make changes during an ADD session or at a separate time.

In this sample EDIT session, we will find the Stanley Products appointment record and make a change to the DIARY data area.

1. Press **1** on the Service Directory to select Enter Data.
2. Place the ENTER DATA diskette in drive A if it is not already there. Press **RETURN**.

You are in the ADD mode right now. (If you wanted to, you could add another record to your appointment calendar at this point.) But now we need to be in the EDIT mode.

WHAT YOU DO

3. Press **CTRL** **B**.

WHAT THE SCREEN DISPLAYS

```

APPOINTMENT CALENDAR =====( PEARL Starter Library )

DATE: █ _____ ( format dates mm/dd/yy or mm dd yy )

TIME: ____ _ (AM/PM) ( format times hh.mm AM or hh.mm PM )

PERSON: _____

PURPOSE: _____

DIARY:

_____
_____
_____

----- ENTER DATA - CONTROL KEY COMMANDS -----

U - Save/Replace record   B - Switch ADD/EDIT   Z - Get next record
N - Duplicate last item   E - Move cursor up   W - Get previous record
P - Print current record  X - Move cursor down O - Delete current record
Q - HELP                  I - Tab forward      ESC - EXIT

EDIT                               ENTER KEY

```

Notice that the ADD at the bottom left of the screen has been changed to EDIT. This means that you can now edit existing stored information. At the bottom right of the screen it says:

ENTER KEY

This is a request to enter something in an indexed data area. The program looks for a matching entry in the stored records. If it finds a matching entry, it displays the record that contains that entry.

Help!

The bottom of the screen tells you which control keys are valid with this screen. The keys that you need to use in the EDIT mode are the same as those used in the ADD mode. The only additions or changes relevant to this screen are:

CTRL-U replaces the information (record) you have already stored with the information that is currently on the screen.

CTRL-B switches you between ADD and EDIT.

CTRL-Z displays the next record in the file.

CTRL-W displays the previous record in the file.

First, find the record you want by tabbing to the appropriate indexed area and typing a value in that area.

WHAT YOU DO

4. Type **S T A N L E Y** on the PERSON line.
5. Press **RETURN**.

WHAT THE SCREEN DISPLAYS

```

APPOINTMENT CALENDAR -----( PEARL Starter Library )

DATE: 4/13/83          ( format dates mm/dd/yy or mm dd yy )

TIME: 9.30 AM (AM/PM)  ( format times hh.mm AM or hh.mm PM )

PERSON: STANLEY PRODUCTS - L. STANLEY_

PURPOSE: INITIAL VISIT_____

DIARY:

BRING SALES LITERATURE AND PRICE SHEET - WANTS TO SEE_____
QUANTITY DISCOUNTS, TOO._____
█_____

----- ENTER DATA - CONTROL KEY COMMANDS -----

U - Save/Replace record   B - Switch ADD/EDIT   Z - Get next record
N - Duplicate last item   E - Move cursor up   W - Get previous record
P - Print current record  X - Move cursor down O - Delete current record
Q - HELP                  I - Tab forward      ESC - EXIT

EDIT

```

The Stanley Products appointment is displayed because your entry matched one in the stored file. Notice that we had to type just enough of the name to uniquely the record.

Another way to find an appointment record is to use CTRL-Z and CTRL-W to search through the file sequentially.

You could, if you wanted to, change any or all the information in this record at this time.

We are only going to change the information on the DIARY line. Position the cursor at the DIARY data area.

WHAT YOU DO

6. Type ASKED ME TO BRING A SALES ORDER FORM ALONG IN CASE WE HAVE WHAT HE WANTS.

WHAT THE SCREEN DISPLAYS

```

APPOINTMENT CALENDAR =====( PEARL Starter Library )

      DATE: 4/13/83           ( format dates mm/dd/yy or mm dd yy )

      TIME:  9.30 AM  (AM/PM)  ( format times hh.mm AM or hh.mm PM )

PERSON: STANLEY PRODUCTS - L. STANLEY_

PURPOSE: INITIAL VISIT_____

DIARY:

      BRING SALES LITERATURE AND PRICE SHEET - WANTS TO SEE_____
      QUANTITY DISCOUNTS, TOO. ASKED ME TO BRING A SALES ORDER__
      FORM ALONG IN CASE WE HAVE WHAT HE WANTS.█_____

----- ENTER DATA - CONTROL KEY COMMANDS -----

U - Save/Replace record   B - Switch ADD/EDIT   Z - Get next record
N - Duplicate last item   E - Move cursor up   W - Get previous record
P - Print current record  X - Move cursor down  O - Delete current record
Q - HELP                  I - Tab forward      ESC - EXIT

EDIT
    
```

6. Press **CTRL U** to replace the old DIARY entry with the new entry.
7. Press **ESC** and press **Y** to return to the Form Directory. Press **ESC** repeatedly to exit from the program.

Summary

You have used Personal Pearl's WELCOME diskette to make working copies of the Personal Pearl programs.

You have learned how to enter information onto a form, and you have learned how to produce reports in various formats and sorting sequences using the information you entered. In addition, you have learned how to edit records that you have stored.

You might use another program from the Starter Library to do the same things you did in this chapter. By that time you will have everything that was presented in this chapter well in mind. And, of course, you will want to experiment a little the second time around. After that, you'll find that it's easy to design forms and reports.

When you have finished the lesson, you'll be ready to go on to the Personal Pearl Easy Tutorial User's Guide. In that book and the two that follow it, you will find out how to create your own input forms and reports, and you will learn about numerous advanced features.

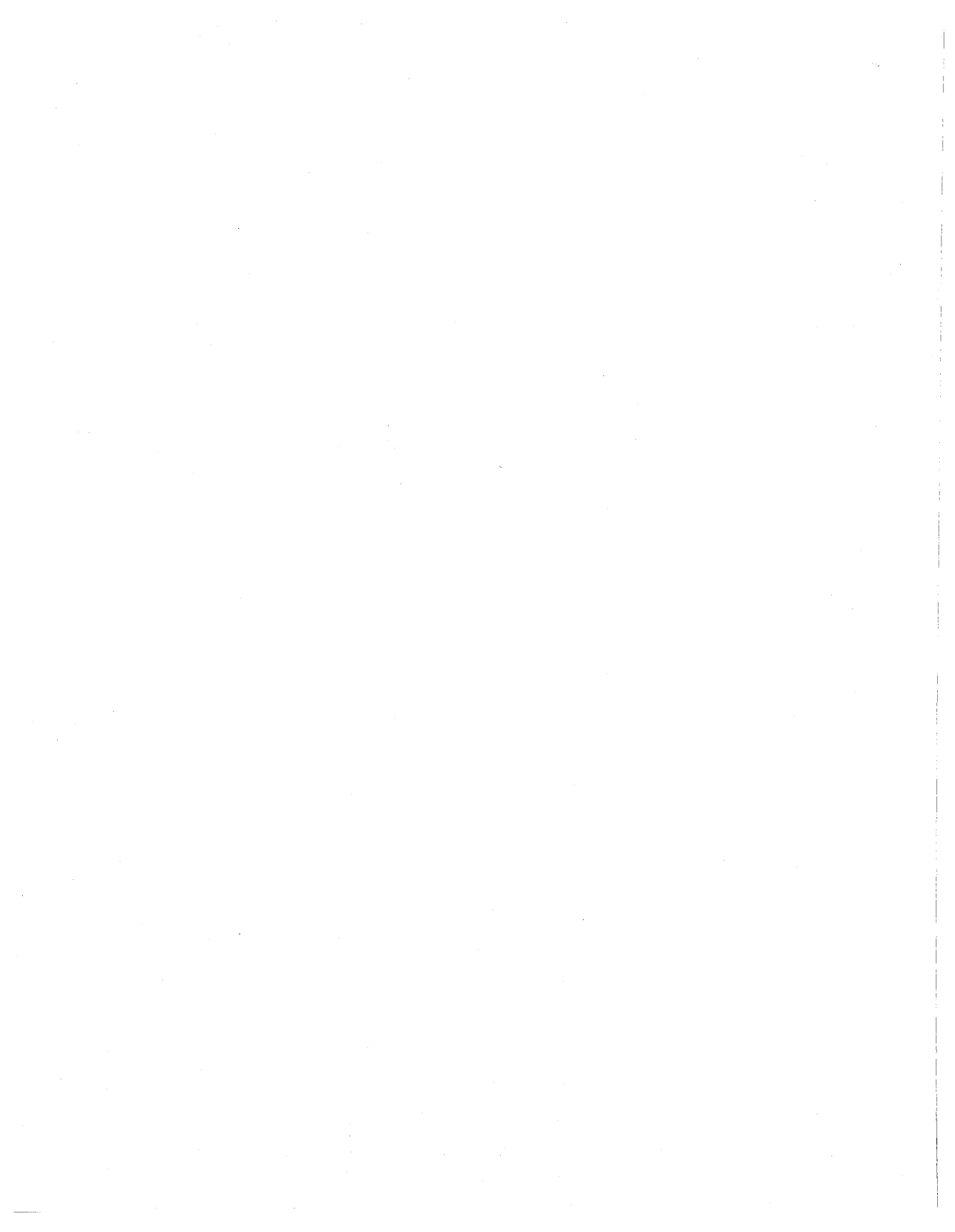



OSBORNE™
COMPUTER CORPORATION