

# Honeywell

## DSS190 AND DSS190B DISK STORAGE SUBSYSTEM REFERENCE MANUAL

SERIES 6000

SUBJECT:

General Description, Functional Description, and Operating Instructions for the DSS190 and DSS190B Disk Storage Subsystems.

SPECIAL INSTRUCTIONS:

This manual supersedes the previous edition, Revision 2, dated May 1974. This edition includes Series 6000 disk storage equipment only. Since the contents of the manual have been extensively revised, change bars and asterisks have not been used.

DATE:

January 1975

ORDER NUMBER:

DB37, Rev. 3

## PREFACE

This manual is a reference document providing hardware-oriented descriptive and instructive material for users of the DSS190 and DSS190B Disk Storage Subsystems and for others concerned with their technical aspects, application, or operation. The basic difference between DSS190 and DSS190B is the use of different disk pack drives. A physical description of each type of disk pack drive is located in Section I.

The manual is divided into three sections: Section I contains a general description of the hardware used in the subsystem, including its performance specifications, capabilities, and optional features. Section II contains a description of the specific functions performed by the subsystem, including data formats, instructions, and status conditions. Section III contains a description of the operator-accessible controls, switches, and indicators, and the procedures necessary to enable personnel to operate the subsystem.

The following manuals supplement the information contained in this manual:

Series 600/6000 Macro Assembler Program (GMAP), Order Number BN86

Series 600/6000 DATANET 355 Communications Processor, Order Number BS03

Series 6000 System Startup and Operation, Order Number DA06

Series 6000 Equipment Operator's Manual, Order Number DA33

## CONTENTS

|            |  | Page   |
|------------|--|--------|
| Section I  | General Description .....                          | 1-1    |
|            | Subsystem Configuration .....                      | 1-1    |
|            | Subsystem Components .....                         | 1-3    |
|            | Disk Storage Control (DSC) .....                   | 1-3    |
|            | Disk Pack Drives .....                             | 1-4    |
|            | Disk Pack .....                                    | 1-5    |
| Section II | Functional Description .....                       | 2-1    |
|            | Component Functions .....                          | 2-1    |
|            | Link Adapter (LA) .....                            | 2-4    |
|            | Disk Storage Control (DSC) .....                   | 2-4    |
|            | Disk Control Adapter (DCA) .....                   | 2-4    |
|            | Disk Storage Unit (DSU) .....                      | 2-4    |
|            | Disk Pack .....                                    | 2-5    |
|            | Basic Track Format .....                           | 2-6    |
|            | Disk Pack Capacity .....                           | 2-7    |
|            | Increased Capacity Format (ICF) .....              | 2-10.1 |
|            | Instruction Set .....                              | 2-11   |
|            | Instructions .....                                 | 2-11   |
|            | Seek .....   | 2-11   |
|            | Special Seek .....                                 | 2-13   |
|            | Preseek .....                                      | 2-13   |
|            | Restore .....                                      | 2-13   |
|            | Read .....   | 2-13   |
|            | Read ASCII .....                                   | 2-13   |
|            | Write .....  | 2-13   |
|            | Write ASCII .....                                  | 2-14   |
|            | Write and Compare .....                            | 2-14   |
|            | Read Nonstandard Size Sector .....                 | 2-14   |
|            | Read Track Header .....                            | 2-14   |
|            | Format Track .....                                 | 2-15   |
|            | Request Status .....                               | 2-15   |
|            | Reset Status .....                                 | 2-15   |
|            | Write Control Register .....                       | 2-15   |
|            | Read Control Register .....                        | 2-16   |
|            | Read Status Register .....                         | 2-16   |
|            | Release .....                                      | 2-16   |
|            | Read EDAC Register .....                           | 2-17   |
|            | Reserve Device .....                               | 2-17   |
|            | Set Standby .....                                  | 2-17   |
|            | Bootload Control Store .....                       | 2-17   |
|            | ITR Boot .....                                     | 2-17   |
|            | Execute Device .....                               | 2-17   |
|            | Execute Microcoded Device (MD) Routine .....       | 2-17   |
|            | Write Control Main Memory, Binary or ASCII .....   | 2-17   |
|            | Read Control Main Memory, Binary or ASCII .....    | 2-17   |
|            | Conditional Write Lock Byte, Write Lock Byte ..... | 2-18   |

CONTENTS (cont)

|  | Page |
|--|------|
| Section II (cont)                                |      |
| Read Lock Byte .....                             | 2-18 |
| Suspend Control .....                            | 2-18 |
| Release Control .....                            | 2-18 |
| Send Special Interrupt .....                     | 2-18 |
| Read Logical Channel Number.....                 | 2-18 |
| Major Status and Substatus .....                 | 2-18 |
| Channel Ready .....                              | 2-18 |
| No Substatus .....                               | 2-18 |
| Retries .....                                    | 2-20 |
| Device in T&D Mode .....                         | 2-20 |
| Data Corrected .....                             | 2-20 |
| Device Busy .....                                | 2-20 |
| Device Positioning .....                         | 2-21 |
| Alternate Channel in Control .....               | 2-21 |
| Attention .....                                  | 2-21 |
| Write Inhibit .....                              | 2-21 |
| Seek Incomplete .....                            | 2-21 |
| Device Inoperable.....                           | 2-21 |
| Device in Standby .....                          | 2-21 |
| Device Offline .....                             | 2-21 |
| Data Alert .....                                 | 2-21 |
| Transfer Timing Alert .....                      | 2-22 |
| Transmission Parity Alert .....                  | 2-22 |
| Invalid Seek Address .....                       | 2-22 |
| Header Verification Failure.....                 | 2-22 |
| Check Character Alert .....                      | 2-22 |
| Compare Alert .....                              | 2-22 |
| End of File .....                                | 2-22 |
| Good Track Detected .....                        | 2-23 |
| Last Consecutive Block .....                     | 2-23 |
| Block Count Limit .....                          | 2-23 |
| Defective Track Detected, Alternate Assigned ..  | 2-23 |
| Defective Track Detected, No Alternate Assigned. | 2-23 |
| Alternate Track Detected .....                   | 2-23 |
| Instruction Rejected .....                       | 2-23 |
| Invalid Operation Code .....                     | 2-23 |
| Invalid Device Code .....                        | 2-24 |
| Parity Alert on IDCW .....                       | 2-24 |
| Invalid Instruction Sequence .....               | 2-24 |
| MPC Device Attention .....                       | 2-24 |
| Configuration Error.....                         | 2-24 |
| Multiple Devices .....                           | 2-24 |
| Device Number Error .....                        | 2-24 |
| CA Error .....                                   | 2-24 |
| Alert EN-1 .....                                 | 2-24 |
| CA EN-1 Error .....                              | 2-25 |
| CA Alert No EN-1 .....                           | 2-25 |
| MPC Device Data Alert .....                      | 2-25 |
| Transmission Parity Error .....                  | 2-25 |
| Inconsistent Command .....                       | 2-25 |
| Checksum Error .....                             | 2-25 |
| Byte Lockout .....                               | 2-25 |
| EDAC Parity Error .....                          | 2-25 |
| Sector Size Error .....                          | 2-25 |
| Nonstandard Sector Size .....                    | 2-25 |
| Search Alert "First Search" .....                | 2-26 |
| Cyclic Code Error "Not First Search" .....       | 2-26 |

CONTENTS (cont)

|   | Page  |
|---|-------|
| Section II (cont)                               |       |
| Search Alert "Not First Search" .....           | 2-26  |
| Sync Byte Error .....                           | 2-26  |
| Alternate Track Error .....                     | 2-26  |
| EDAC Correction - Last Sector .....             | 2-26  |
| EDAC Correction - Not Last Sector .....         | 2-26  |
| EDAC Correction - Block Count Limit .....       | 2-26  |
| EDAC Uncorrectable .....                        | 2-26  |
| EDAC Correction - Short Block .....             | 2-26  |
| MPC Command Reject .....                        | 2-26  |
| Illegal Procedure .....                         | 2-26  |
| Illegal Logical Channel Number .....            | 2-27  |
| Illegal Suspend .....                           | 2-27  |
| Continue Bit Not Set .....                      | 2-27  |
| Section III                                     |       |
| Operating Instructions .....                    | 3-1   |
| Subsystem Considerations .....                  | 3-1   |
| Subsystem Controls and Indicators .....         | 3-2   |
| DSC Operating Controls and Indicators .....     | 3-2   |
| AC Breaker On .....                             | 3-3   |
| Power On .....                                  | 3-3   |
| Power Off .....                                 | 3-3   |
| Normal/Test .....                               | 3-4   |
| Ready/Trouble .....                             | 3-4   |
| Over Temp/Alarm Reset .....                     | 3-4   |
| Start .....                                     | 3-4   |
| Automatic/Manual .....                          | 3-4   |
| Int/Ext/Cont Store .....                        | 3-4   |
| Operator Interrupt .....                        | 3-5   |
| Halted .....                                    | 3-5   |
| Initialize .....                                | 3-5   |
| Address/Simulate .....                          | 3-5   |
| Control Configuration Switches .....            | 3-5   |
| DSU190 Operating Controls and Indicators .....  | 3-5.2 |
| DSU190B Operating Controls and Indicators ..... | 3-5.2 |
| Subsystem Operation .....                       | 3-7   |
| DSC Operation .....                             | 3-8   |
| DSU Operation .....                             | 3-8   |
| DSU190 Initialization .....                     | 3-8   |
| DSU190 Disk Pack Installation .....             | 3-8   |
| DSU190 Disk Pack Removal .....                  | 3-9   |
| DSU190B Initialization .....                    | 3-9   |
| DSU190B Disk Pack Installation .....            | 3-10  |
| DSU190B Disk Pack Removal .....                 | 3-10  |
| Emergency Operation .....                       | 3-11  |
| Subsystem Maintenance .....                     | 3-11  |
| DSC/DSU Maintenance .....                       | 3-11  |
| Disk Pack Maintenance .....                     | 3-11  |
| Handling the Disk Pack .....                    | 3-11  |
| Storing the Disk Pack .....                     | 3-12  |

\*

## ILLUSTRATIONS

|               |   | Page   |
|---------------|---|--------|
| Figure 1-1.   | Basic Subsystem .....   | 1-1    |
| Figure 1-2.   | 16-Device Subsystem .....   | 1-1    |
| Figure 1-3.   | Dual Control Subsystem .....  | 1-2    |
| Figure 1-4.   | Dual Subsystem with Four Simultaneous Channels .....                                | 1-2    |
| Figure 1-5.   | Disk Storage Control (DSC) .....  | 1-3    |
| Figure 1-6A.  | Disk Pack Drive DSU190 .....  | 1-4    |
| Figure 1-6B.  | Disk Pack Drive DSU190B .....   | 1-5    |
| Figure 1-7.   | Disk Pack .....   | 1-6    |
| Figure 2-1.   | DSS190 or DSS190B with Six Additional Devices and a<br>Switched Channel .....       | 2-2    |
| Figure 2-2.   | DSS190 or DSS190B with 14 Additional Devices and Two<br>Simultaneous Channels ..... | 2-2    |
| Figure 2-3.   | Dual Control (Two Single Channels) Crossbarred<br>Subsystem (DCX) .....             | 2-3    |
| Figure 2-4.   | Two Control Dual Channel Crossbarred Subsystem .....                                | 2-3    |
| Figure 2-5.   | Disk Pack Recording Surfaces .....  | 2-6    |
| Figure 2-6.   | Basic Track Format .....  | 2-7    |
| Figure 2-7.   | Home Address Field .....  | 2-8    |
| Figure 2-8.   | R0 Field .....  | 2-9    |
| Figure 2-9.   | R1 Field .....  | 2-10   |
| Figure 2-10A. | Increased Capacity Format (ICF) .....   | 2-10.1 |
| Figure 2-10B. | CO Count Field .....  | 2-10.2 |
| Figure 2-10C. | Data Fields .....   | 2-10.3 |
| Figure 2-10D. | CN Count Field .....  | 2-10.4 |
| Figure 2-11.  | Seek Instruction Format .....   | 2-11   |
| Figure 2-12.  | Track Header Format .....   | 2-14   |
| Figure 2-13.  | Format Track Data Format .....  | 2-15   |
| Figure 2-14.  | Read Control Register Format .....  | 2-16   |
| Figure 3-1.   | DSC Operating Controls and Indicators (Freestanding<br>Control) .....               | 3-3    |
| Figure 3-2.   | Operating Controls and Indicators (Control Integrated<br>in ICU) .....              | 3-3    |
| Figure 3-3.   | Control Configuration Switches .....  | 3-5.1  |
| Figure 3-4.   | DSU190 Operating Control and Indicators .....                                       | 3-5.2  |
| Figure 3-5.   | DSU190B Operating Controls and Indicators .....                                     | 3-5.2  |

## TABLES

|            |   |       |
|------------|---|-------|
| Table 2-1  | Functional Characteristics of the Disk Storage Unit ..... | 2-5   |
| Table 2-2. | Disk Pack Capacity (Basic Track Format) .....             | 2-7   |
| Table 2-3. | Instruction Set .....                                     | 2-12  |
| Table 2-4. | Special Instruction Set .....                             | 2-13  |
| Table 2-5. | Major Status and Substatus Codes .....                    | 2-19  |
| Table 3-1. | Control Configuration Switches .....                      | 3-5.1 |
| Table 3-2. | DSU190 Controls and Indicators .....                      | 3-5.2 |
| Table 3-3. | DSU190B Controls and Indicators .....                     | 3-7   |

SECTION I  
GENERAL DESCRIPTION

The Type DSS190 and Type DSS190B Disk Storage Subsystems are high-capacity disk storage subsystems with advanced microprogrammed control and operating features that improve time and throughput. This subsystem provides fast access and large capacity storage for remote access, multiprocessing, and time sharing in medium to large data base systems.

SUBSYSTEM CONFIGURATION

The basic subsystem consists of a disk storage control (DSC) and two disk pack drives using removable and interchangeable disk packs (see Figure 1-1). Storage capacity is 117,903,360 six-bit characters or 78,602,240 eight-bit bytes per disk pack (or 91,375,104 six-bit characters or 68,531,328 eight-bit bytes using a basic track format). This capacity can be expanded by the addition of up to 16 devices (see Figure 1-2), or 32 devices for maximum online capacity using a single or dual subsystem (see Figure 1-3). Figure 1-4 presents a further expansion making use of a dual control subsystem with four simultaneous channels.

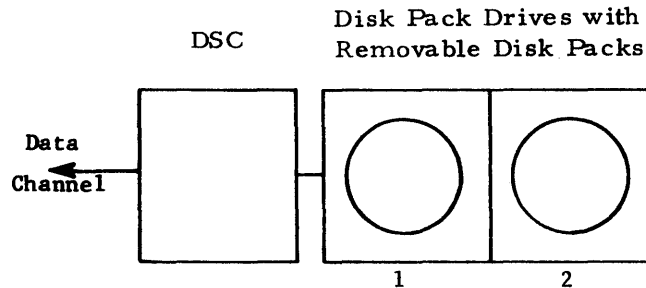

Figure 1-1. Basic Subsystem

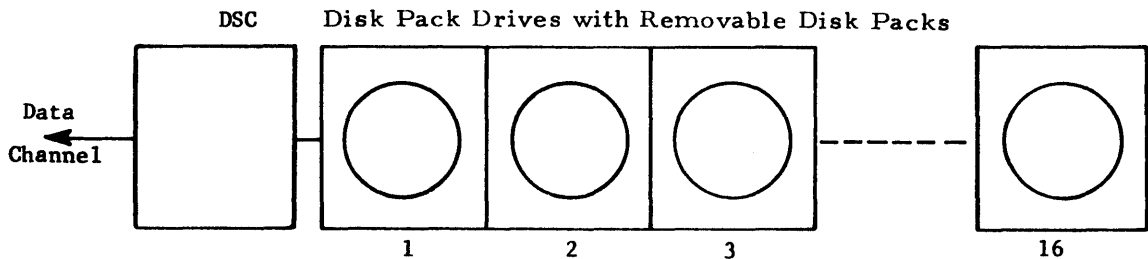

Figure 1-2. 16-Device Subsystem

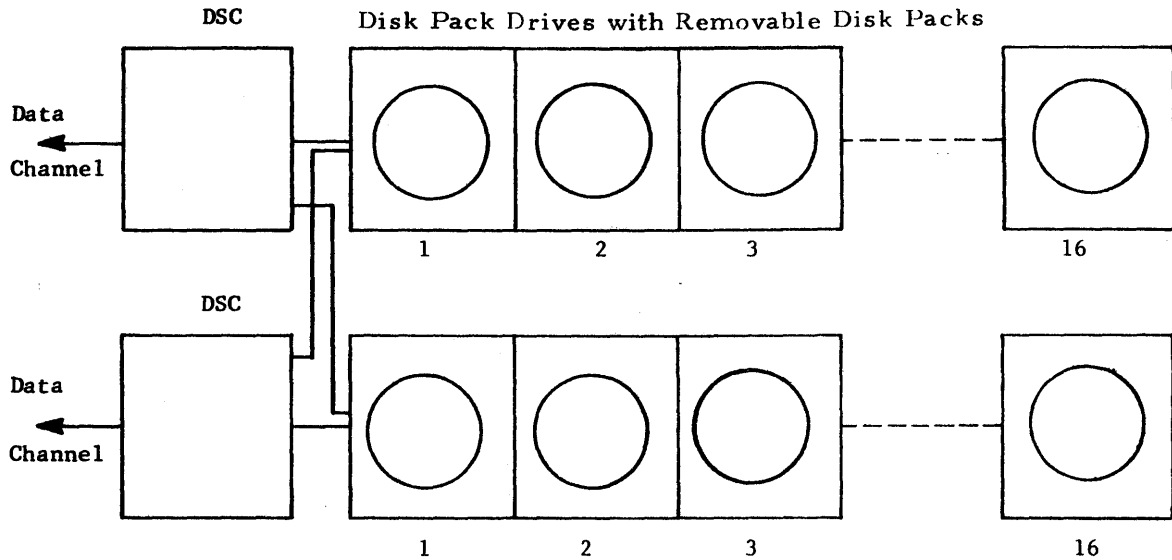
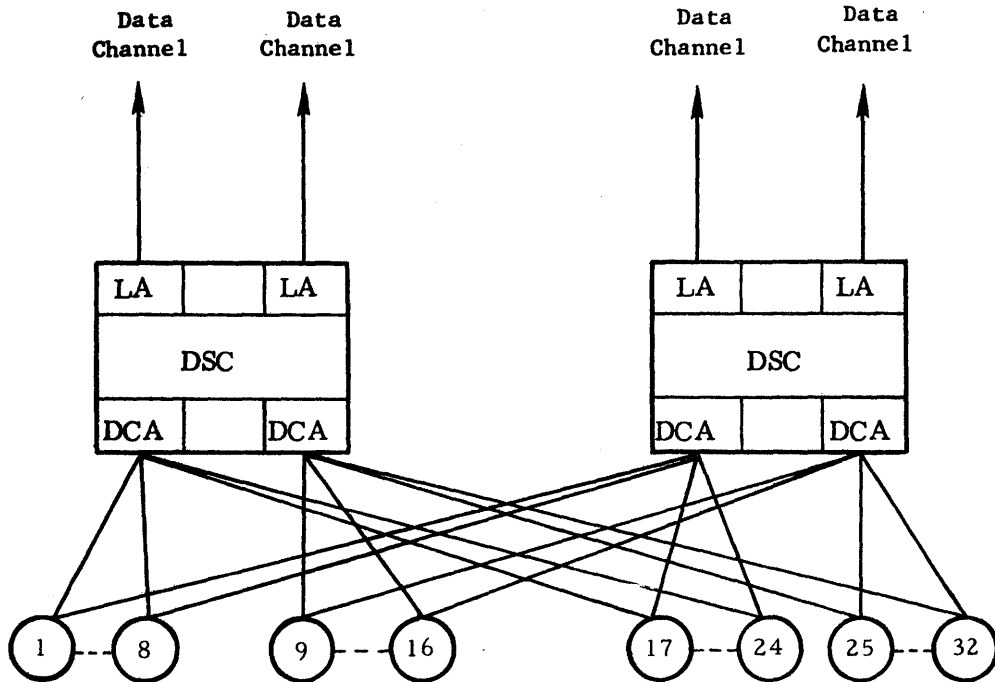

Figure 1-3. Dual Control Subsystem



NOTE:  
 LA - Link Adapter  
 DSC - Disk Storage Control  
 DCA - Disk Control Adapter

Figure 1-4. Dual Subsystem with Four Simultaneous Channels



Subsystems can be easily upgraded in the field by adding the various optional components available. This modularity makes it possible to provide backup components for every module in the subsystem with a maximum of versatility.

## SUBSYSTEM COMPONENTS

### Disk Storage Control (DSC)

The DSC is a general purpose microinstruction processor housed in a single low-profile cabinet with an easily accessible operator panel (see Figure 1-5), or in the Integrated Control Unit (ICU). The modular design of the DSC allows expansion and enhancement of basic subsystem capacity simply by installing optional hardware.

In addition to the operator panel, the DSC includes:

- A maintenance/configuration panel
- Forced-air cabinet cooling system
- Power supply and power control modules
- A basic disk channel with a link adapter interface to the external user system (EUS)
- An Additional Drive Electronics, ADE190, with a disk interface to the disk pack drives. The disk interface can connect up to four disk pack drives to the DSC

## PHYSICAL SPECIFICATIONS

### Dimensions

51 in. high  
55 in. wide  
28 in. deep

### Installed Weight

500 lb

### Square Footage (including door swing)

30.5 sq. ft

## OPERATING ENVIRONMENT

Temperature 50° - 100° F (10° - 38°C)  
Humidity 10% - 85%

## POWER REQUIREMENTS

120/208 V, 60 Hz  
1.83 kVA

## AIR CONDITIONING

4650 Btu/hr

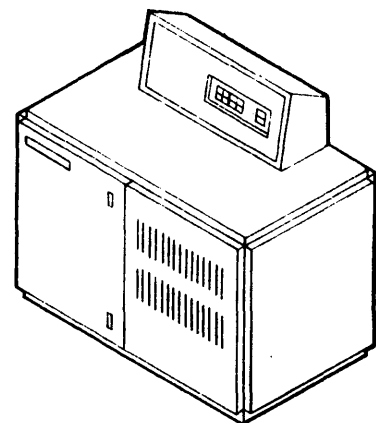

Figure 1-5. Disk Storage Control (DSC)

Options to the DSC include:

- A Dual Simultaneous Channel, DCH190 and DCH190B, consisting of one basic disk channel, one Additional Drive Electronics (ADE190 and ADE190B) and one data recovery module, for dual-channel crossbar operation in which data can be transferred between the DSC and two disk pack drives simultaneously.
- An Additional Data Channel, ADC190 and ADC190B, provides a second link adapter interface to the external user system (EUS) for transferring data between the DSC and EUS on both interfaces, but not simultaneously. One ADC190 or ADC190B may be applied to the DSC and one to the optional Dual Simultaneous Channel, DCH190 or DCH190B.
- For two controls with single channels, a Dual Control Crossbar, DCX190 and DCX190B, and a disk Control Adapter, CCA190 and CCA190B, are required to provide crossbarring to all drives.
- For two controls with dual channels, DCH190 and DCH190B, crossbarring is provided to all drives. (DCX190 or DCX190B is not required.)

### Disk Pack Drives

The disk pack drive used by the subsystem is either the DSU190 or the compatible DSU190B Disk Storage Unit. The DSU190 (Figure 1-6A) is an electromechanical disk pack drive with a single mounting spindle housed in a low-profile cabinet. The DSU190B (Figure 1-6B) is a single-spindle, moving-head disk pack drive, with associated Device Oriented Electronics (DOE) housed in a single low-profile cabinet. Both disk pack drives include easily accessible chambers for mounting the disk pack and convenient operator control panels.

### PHYSICAL SPECIFICATIONS

#### Dimensions

38 in. high  
22 in. wide  
49 in. deep

#### Installed Weight

700 lb

#### Square Footage (including door swing)

12 sq. ft

### OPERATING ENVIRONMENT

Temperature 60° - 90° F (15° - 32° C)  
Humidity 20% - 80%

### POWER REQUIREMENTS

208 V, 60 Hz/220 V, 50 Hz  
1.5 kVA

### AIR CONDITIONING

4425 Btu/hr

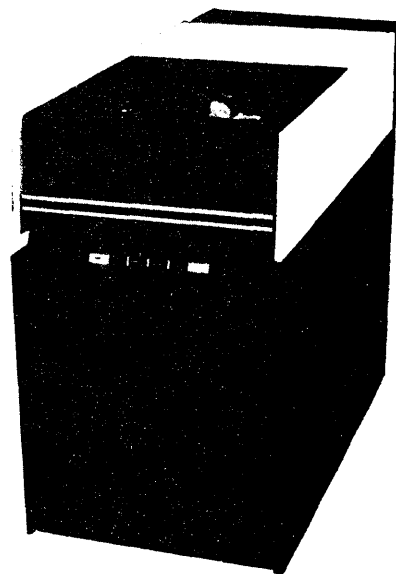

Figure 1-6A. Disk Pack Drive (DSU190)

## PHYSICAL SPECIFICATIONS

### Dimensions

42.25 in. high  
35 in. wide  
30 in. deep

### Installed Weight

850 lb

### Square Footage

15 sq ft

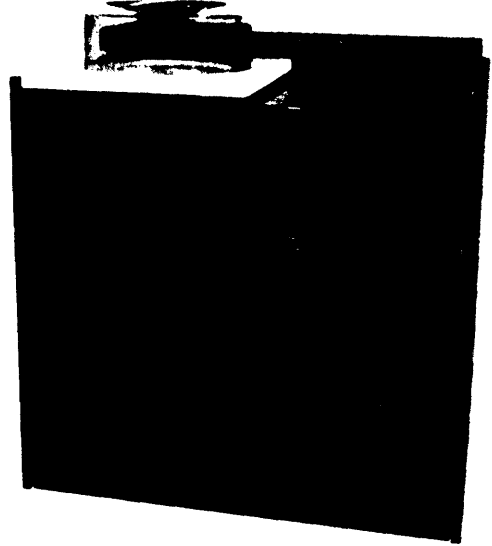

## OPERATING ENVIRONMENT

Temperature 60° - 90° F (15° - 32° C)  
Humidity 20% - 80%

## POWER REQUIREMENTS

208 V, 60 Hz  
2.0 kVA

Figure 1-6B. Disk Pack Drive DSU190B

In addition to the disk pack chamber and operator control panel, the disk pack drive includes:

- The disk pack rotating mechanism
- The mechanism that positions the read/write heads with respect to the disk recording surfaces
- The brush mechanism that cleans the disk recording surfaces during each power-up sequence
- Two ports that permit the disk pack drive to be connected for simultaneous dual-channel crossbar operation
- Direct current power supplies and power supply controls

### Disk Pack

The Disk Storage Subsystem uses an M4050 Disk Pack or an equivalent removable disk pack (see Figure 1-7). The disk pack includes ten 14-inch storage disks and two protective disks mounted on a common hub, and an easy-to-handle plastic carrying storage case.

The disk pack can be removed conveniently for offline storage, and may be remounted readily for online processing.

## PHYSICAL SPECIFICATIONS

### Disk Dimensions

14 in. diameter

### Number of Disks

12 Storage Disks (spaced 0.3 in.  
apart on a common hub)

2 protective disks (on same hub)

### Number of Storage Surfaces

19 Data

1 Servo

### Weight

20 lb (with carrying case)

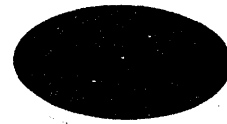
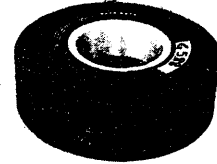

## OPERATING ENVIRONMENT

Temperature 15° - 32° C

Humidity 20% - 80%

## STORAGE CAPACITY

91,375,104 six-bit characters

68,531,328 eight-bit characters

Figure 1-7. Disk Pack

SECTION II  
FUNCTIONAL DESCRIPTION

COMPONENT FUNCTIONS

The Disk Storage Subsystem may be configured in many different ways to obtain data availability and throughput requirements. Versatility, especially adaptability to new requirements, is significantly increased by the use of a microprogrammed peripheral control as the disk storage control (DSC) for the subsystem. The disk storage units (disk pack drives and disk packs) communicate with the DSC across a radial interface that permits a DSU to be removed from service without interfering with the operation of other DSU's in the subsystem.

Four of various subsystem configurations that may be used in a computer system are shown in Figures 2-1 through 2-4. The abbreviations used are:

|           |  |
|-----------|--|
| ADE       | – Additional Drive Electronics   |
| CCA or CA | – Control Adapter  |
| DCA       | – Disk Control Adapter   |
| DCX       | – Dual Control Crossbar (includes associated cables and additional EDE electronics)                                |
| DSC       | – Disk Storage Control (refers to the complete control)  |
| DSS       | – Disk Storage Subsystem   |
| DSU       | – Disk Storage Unit (refers to the DSU190 and DSU190B Disk Storage Units unless noted otherwise)                   |
| EDAC      | – Error Detection and Correction   |
| EDE       | – Extended Drive Electronics   |
| EUS       | – External User System (refers to any Series 6000 Central System or DATANET 355 Front-End Network Processor)       |
| IDCW      | – Instruction Data Control Word  |
| LA        | – Link Adapter   |
| OPI       | – Operational In (a status line from the device to the controller indicating the operational status of the device) |

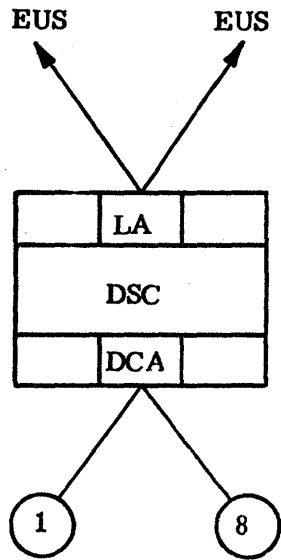

Figure 2-1. DSS190 or DSS190B with Six Additional Devices and a Switched Channel

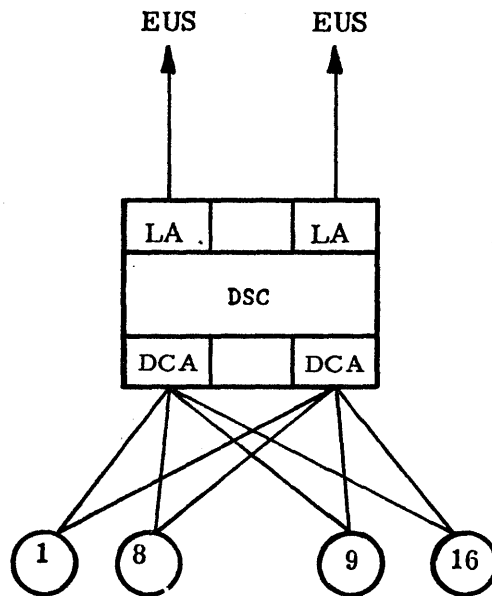
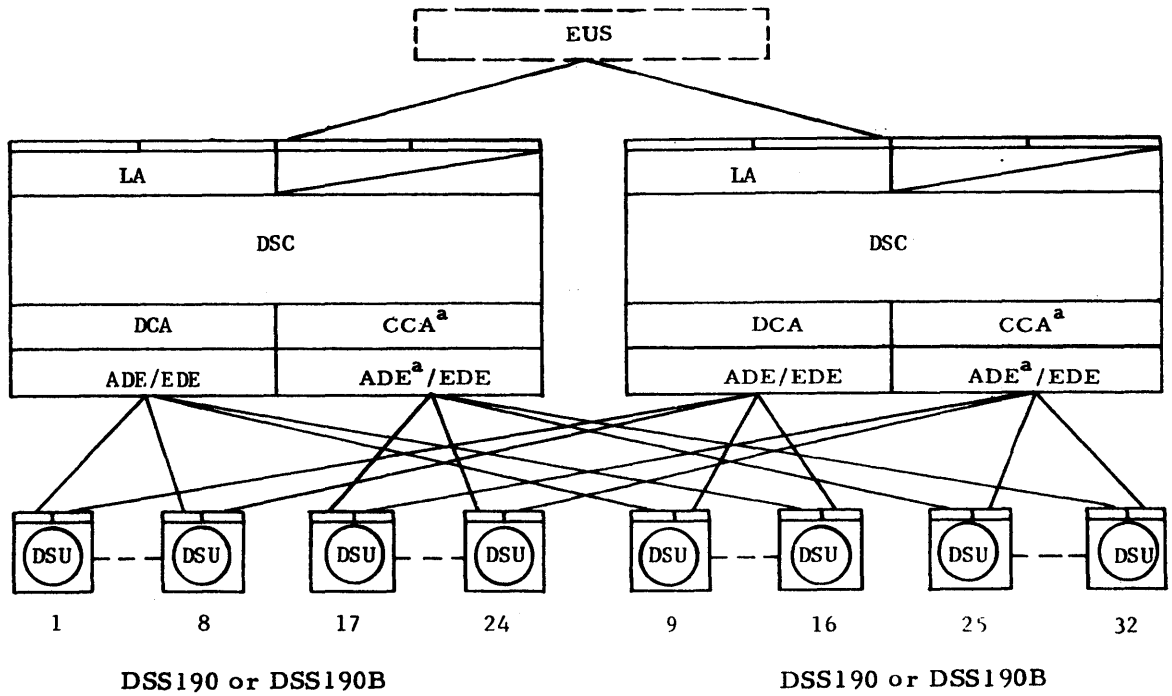

Figure 2-2. DSS190 or DSS190B with 14 Additional Devices and Two Simultaneous Channels



<sup>a</sup>Required with 17 or more drives

Figure 2-3. Dual Control (Two Single Channels) Crossbarred Subsystem (DCX)

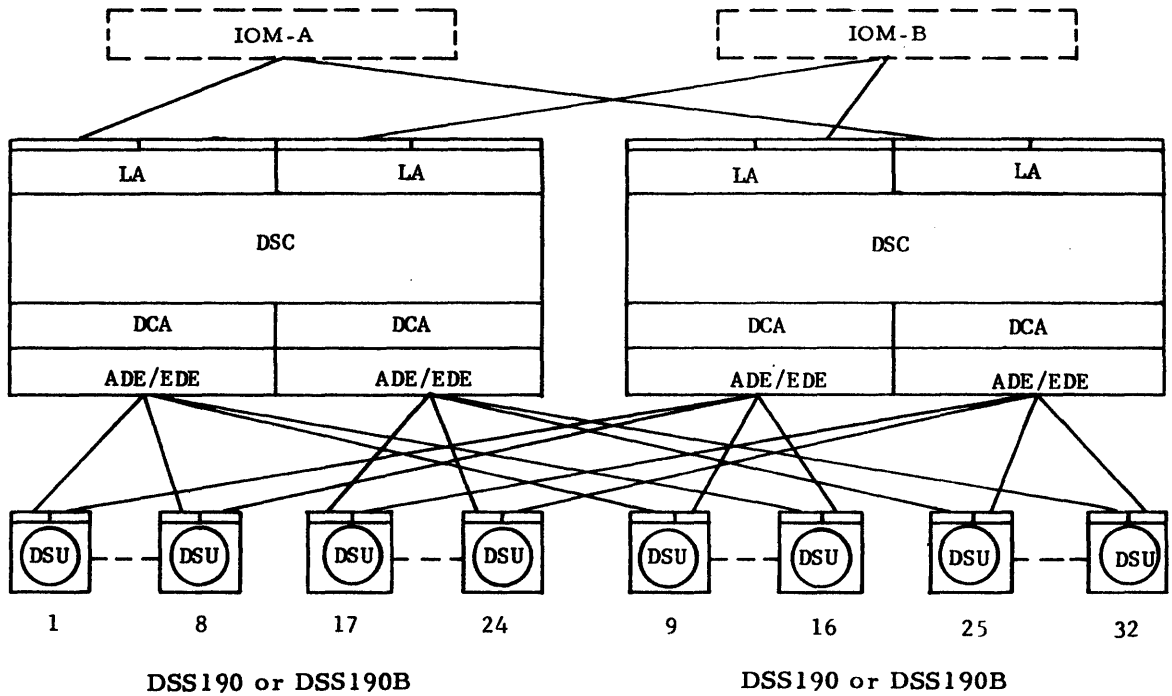

Figure 2-4. Two Control Dual Channel Crossbarred Subsystem

### Link Adapter (LA)

The LA connects the DSC to the EUS as shown in Figure 2-1 through 2-4. Each LA has two ports, providing the ability for the LA to be shared by two physical interface channels for nonsimultaneous transfer of data between the EUS and the DSC. Channel switching is controlled by the DSC microprograms.

### Disk Storage Control (DSC)

The DSC is a general purpose, register-to-register microinstruction processor that performs the control functions for the subsystem. The DSC accepts macro instructions from the EUS and issues the necessary machine instructions to the DSU's via the DCA. The DSC also obtains status from the DSU's and returns the appropriate status to the EUS. Four ports are provided in the DSC for connecting as many as two LA's and two DCA's.

### Disk Control Adapter(DCA)

The DCA connects the DSC to the DSU's through the Additional Drive Electronics (ADE/EDE) as shown in Figures 2-1 through 2-4. The DCA synchronizes, buffers, and converts information to be transferred between the DSC and the DSU's. Information is transferred by the DCA to or from only one DSU at a time. Two independent DCA's each can transfer information to or from different DSU's simultaneously.

### Disk Storage Unit (DSU)

The DSU is a disk pack drive capable of reading from or writing in bit serial form on any of the tracks of a 19-recording surface, 411-track removable disk pack. To be interchangeable, all disk packs must be aligned with the same master alignment pack. Two channels in the DSU permit the DSU to be connected to two DCA's for simultaneous data transfer operations between the DSU and the EUS. DSU functional characteristics are listed in Table 2-1.



Table 2-1. Functional Characteristics of the Disk Storage Unit

| <u>Characteristic</u>   | <u>Description</u>                                    |
|---|---|
| Removable Disk Pack   | M4050 (or equivalent)                                 |
| Spindle Rotation  | 3600 rpm  |
| Disk Latency Time   | 8.3 ms (average)<br>16.7 ms (maximum)                 |
| <b>Heads</b>  |   |
| R/W Heads   | 19  |
| Loading Mechanism   | Ramp  |
| Servo Heads   | 1   |
| <b>Recording</b>  |   |
| Mode  | Modified Frequency Modulation (MFM)                   |
| Data Rate   | 806,000 bytes per second                              |
| Density – outer track   | 2684 bpi  |
| Density – inner track   | 4040 bpi  |
| Head Positioning Times <sup>a</sup><br>(Track-to-Track)   | 55 ms (maximum)<br>30 ms (average)<br>10 ms (minimum) |
| <sup>a</sup> Does not include disk latency time or time to read data. Average head selection time = 6 $\mu$ s |   |

Disk Pack

The disk pack used with the DSU is a removable, interchangeable disk with 19 magnetic recording surfaces numbered 0 - 18 (see Figure 2-5). Each recording surface has 411 concentric tracks for a maximum total of 7809 tracks. The tracks on each recording surface are numbered 000 - 410, track number 410 being the innermost. A group of 19 tracks (tracks with the same number for each of the 19 recording surfaces) constitutes a cylinder, i. e., tracks numbered 001 for each of the 19 recording surfaces comprise cylinder 001. So, there are 411 cylinders for each disk pack. Cylinders 000 through 409 (7790 tracks) are allocated to user data, system labels, catalogs, alternate tracks, and other information; cylinder 410 (19 tracks) is reserved for T & D use only. Of the 410 cylinders available, 404 cylinders are addressable, three cylinders are reserved as alternate cylinders, and three additional cylinders are addressable to offset any tracks that are deallocated.

## BASIC TRACK FORMAT

The basic track format contains a home address area, a track descriptor sector, and from one to 31 user data sectors per track as shown in Figure 2-6. Portions of the track format are described in more detail in Figures 2-7, 2-8, and 2-9 (cross-referenced in Figure 2-6).

- Home Address Field — Figure 2-7
- R0 Field — Figure 2-8
- R1 Field — Figure 2-9

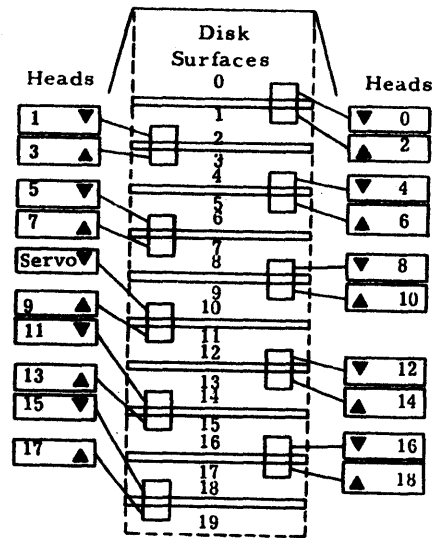

Figure 2-5. Disk Pack Recording Surfaces

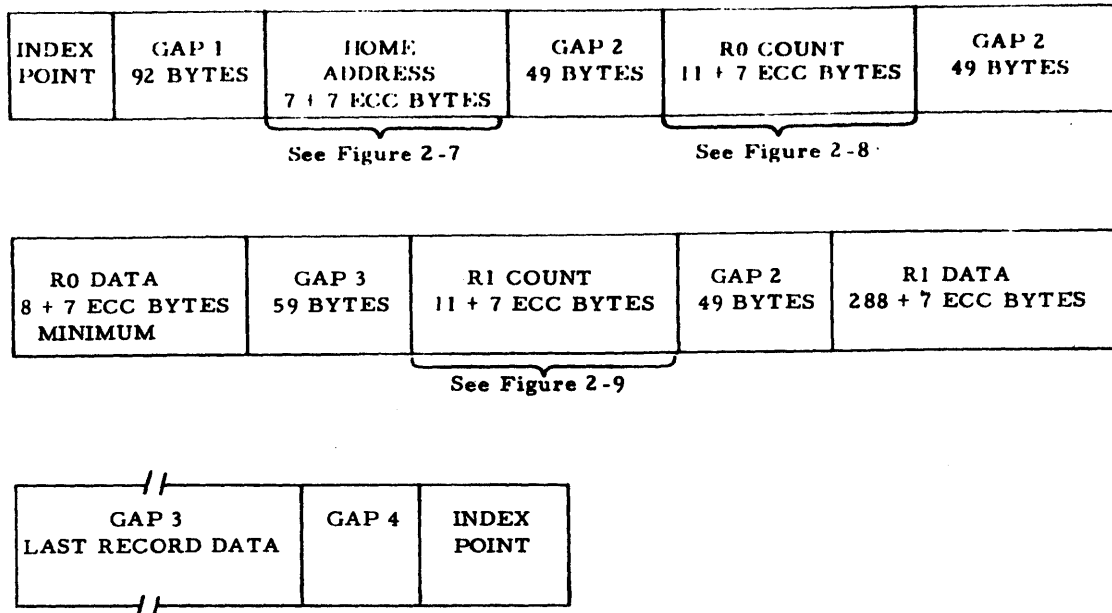

Figure 2-6. Basic Track Format

#### DISK PACK CAPACITY

The storage capacity of a disk pack and of the track format are shown in Table 2-2. Capacity measurements include lengths of fields measured in bytes (8 bits), in words (36 bits), and characters (6 bits).

Table 2-2. Disk Pack Capacity (Basic Track Format)

| Bytes/<br>Sector | Sector/<br>Track | Bytes/<br>Track | Words/<br>Sector | 288-Byte<br>Fields/Track | Bytes/Disk Pack<br>$\times 10^6$ | Formatted<br>Characters/<br>Disk Packs<br>$\times 10^6$ |
|------------------|------------------|-----------------|------------------|--------------------------|----------------------------------|---|
| 288              | 31               | 8928            | 64               | 31                       | 68.5                             | 91.3 <sup>a</sup>                                       |

<sup>a</sup>Based on 404 cylinders

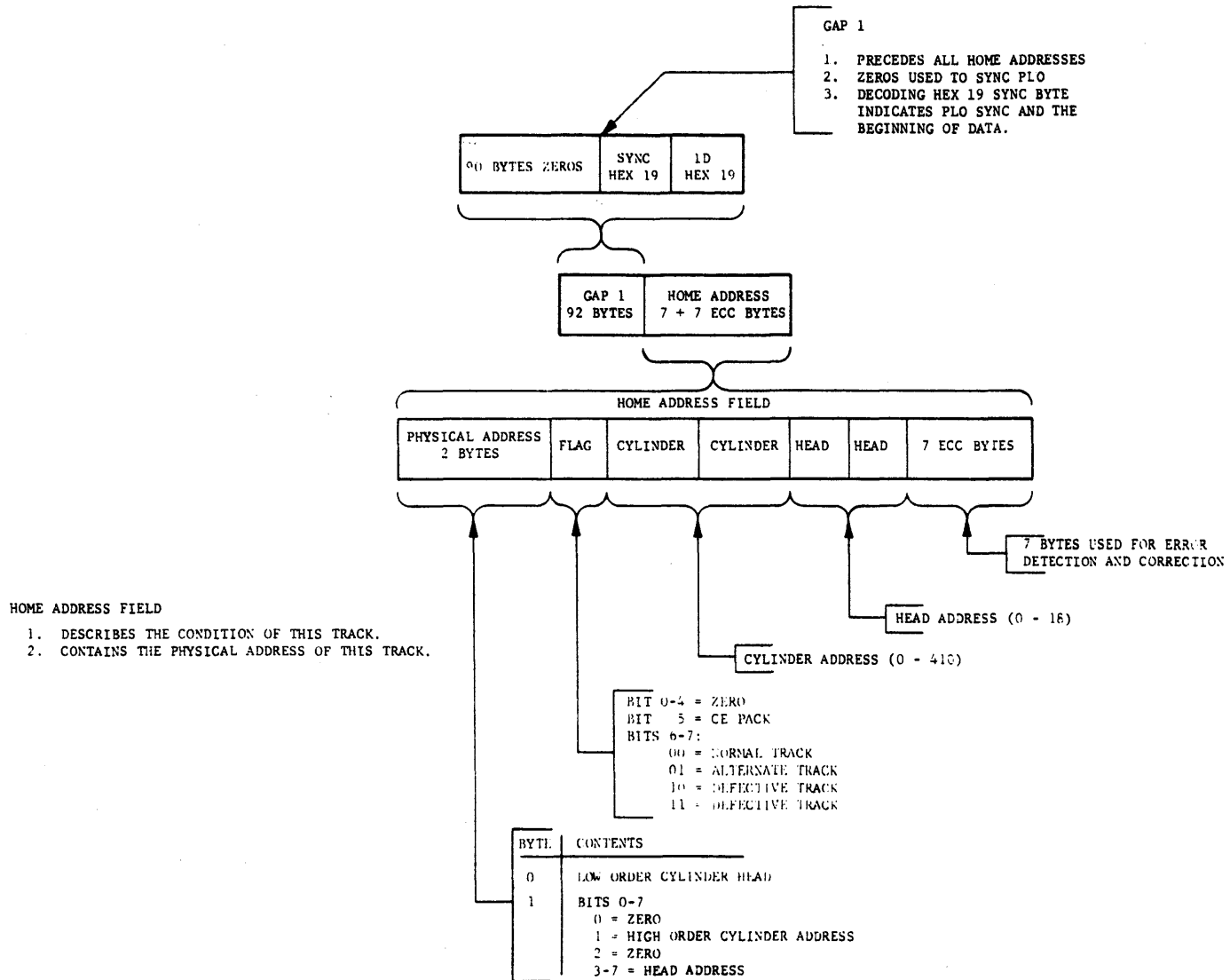
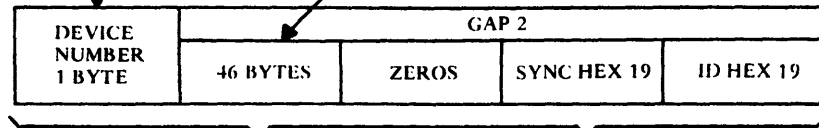

Figure 2-7. Home Address Field

THIS BYTE WRITTEN AT THE END OF HOME ADDRESS. COUNT, AND DATA FIELDS TO IDENTIFY THE DEVICE AND CHANNEL NUMBER USED WHEN THIS BYTE WAS WRITTEN ON THE TRACK

ALL SPLICES MADE IN THIS AREA



RO FIELD: USED BY OPERATING SYSTEM FOR ADDRESS OF ALTERNATE TRACK OR DEFECTIVE TRACK.

- GAPS ALLOW TIME TO CHANGE FROM READ TO WRITE STATE OR WRITE TO READ STATE.
- SYNC AND ID HEX 19 SAME AS GAP 1.

RO DATA FIELD: 8 BYTES

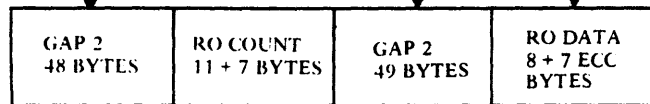

RO COUNT FIELD HAS THE SAME CCHH AS HOME ADDRESS EXCEPT WHEN USED FOR ALTERNATE OR DEFECTIVE TRACK ADDRESS

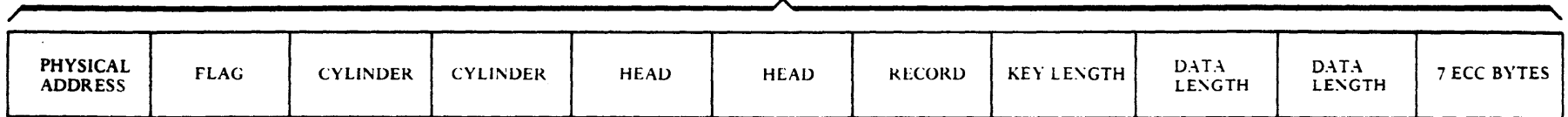

SAME AS HOME ADDRESS

CYLINDER ADDRESS  
(0-410)

HEAD ADDRESS  
(0-18)

DEFECTIVE TRACK = USE CCHH OF ALTERNATE TRACK  
ALTERNATE TRACK = USE CCHH OF DEFECTIVE TRACK

NUMBER OF BYTES IN THE DATA FIELD 8

7 BYTES USED FOR ERROR DETECTION AND CORRECTION

NUMBER OF THIS RECORD (ZERO)

NUMBER OF BYTES IN THE KEY FIELD (ZERO)

DEFINES THE CONDITION OF THE TRACK.

BITS 0-5 = UNUSED AND WRITTEN AS ZEROS

BITS 6-7 = INDICATES CONDITION OF TRACK

- 00 = NORMAL TRACK
- 01 = ALTERNATE TRACK
- 10 = DEFECTIVE TRACK

Figure 2-8. RO Field

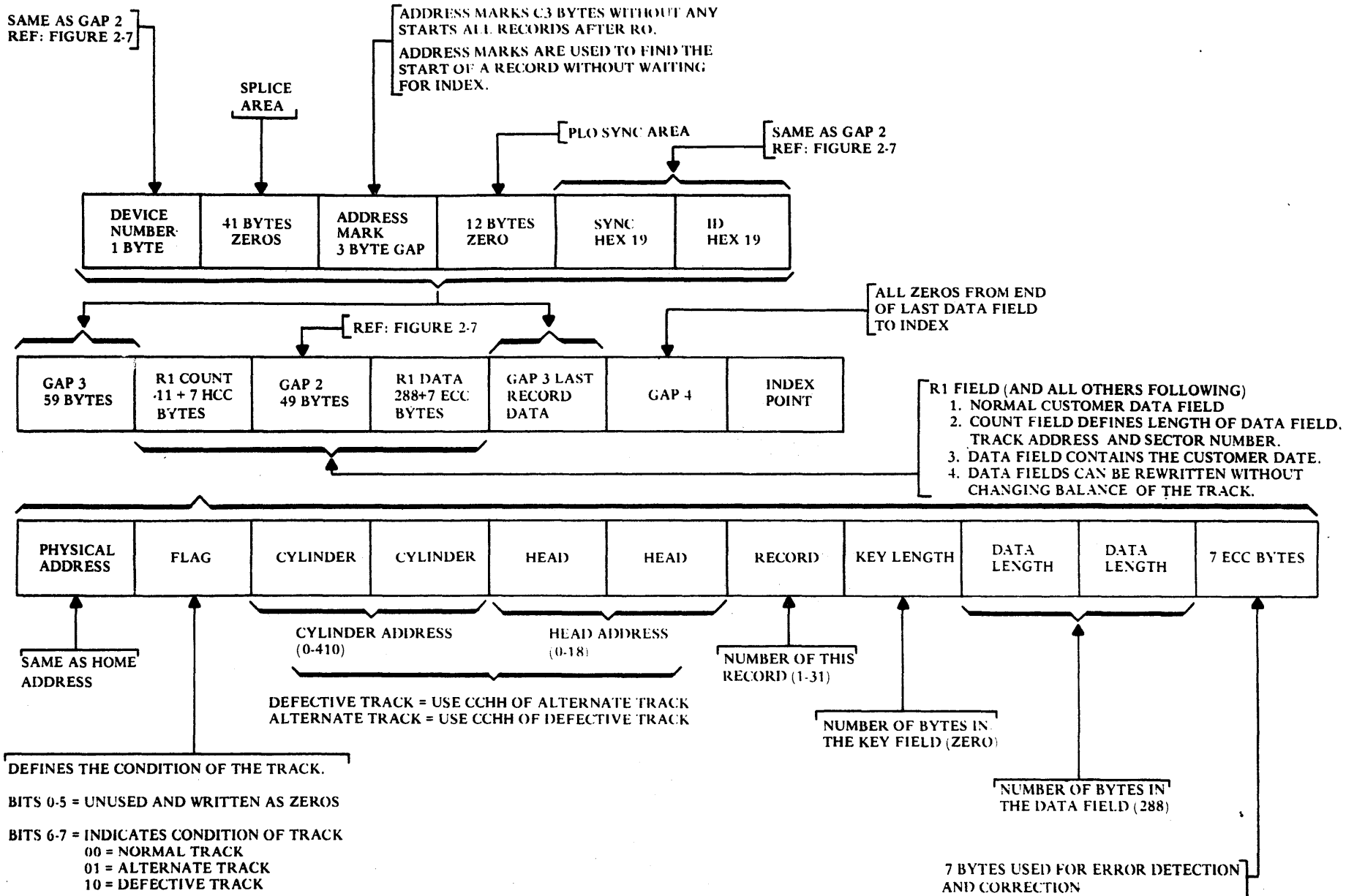
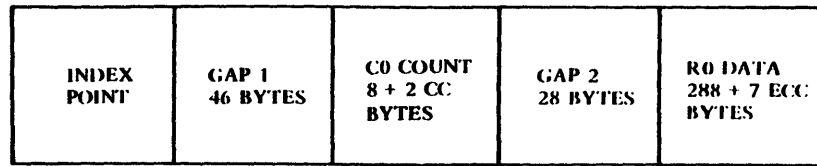

Figure 2-9. R1 Field

**INCREASED CAPACITY FORMAT (ICF)**

The ICF track format contains 40 user data sectors per track as shown in Figure 2-10. The C0 count field, data fields, and CN count field are described in detail in Figures 2-10A through 2-10D.



SEE FIGURE 2-10B

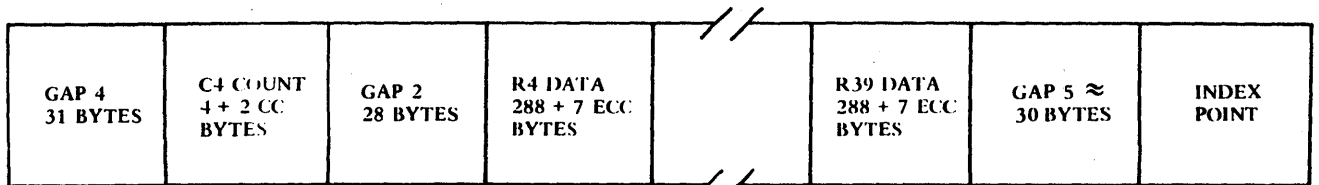
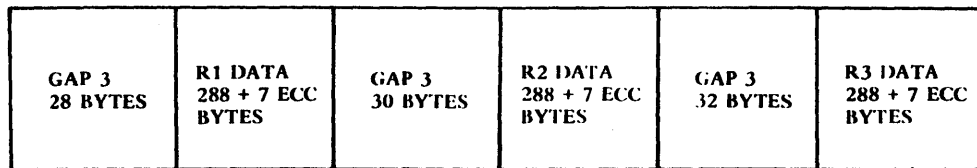

**Figure 2-10A. Increased Capacity Format (ICF)**

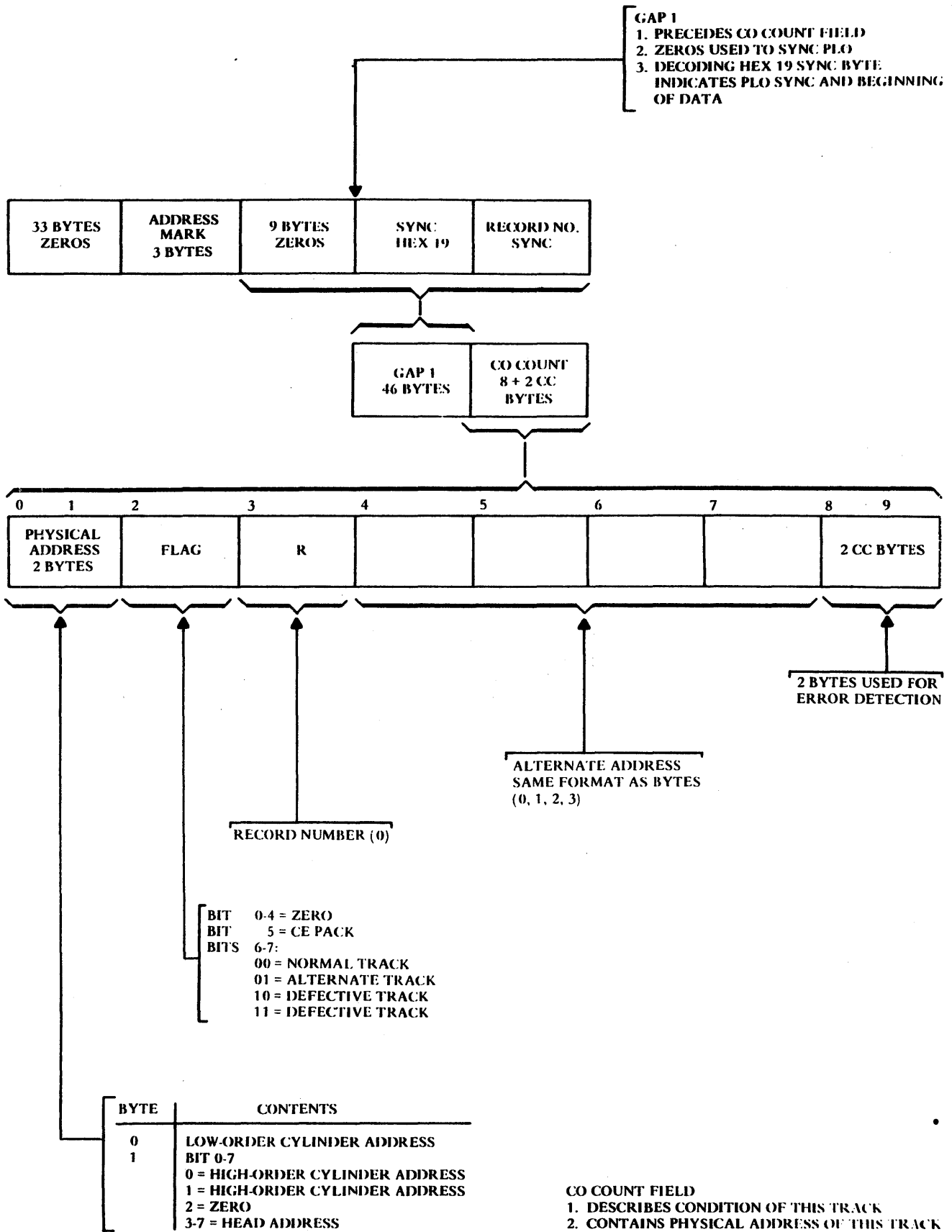
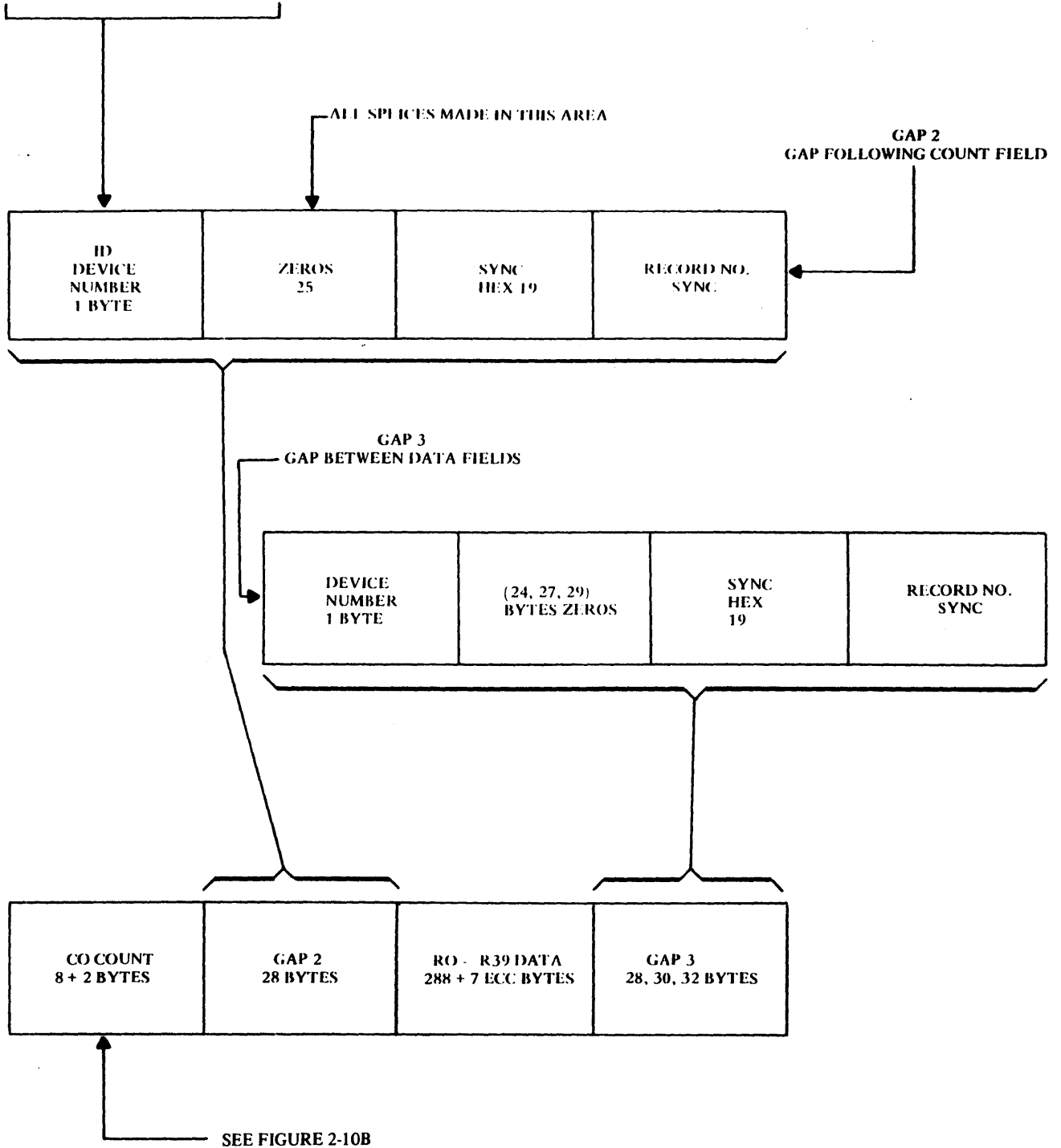

Figure 2-10B. C0 Count Field



THIS BYTE WRITTEN AT  
END OF AU COUNT AND DATA  
FIELDS TO IDENTIFY  
DEVICE AND CHANNEL NUMBER  
USED WHEN THIS BYTE WAS  
WRITTEN ON TRACK



- GAPS ALLOW TIME TO CHANGE FROM READ TO WRITE STATE OR WRITE TO READ STATE
- SYNC HEX 19 SAME AS GAP 1

Figure 2-10C. Data Fields

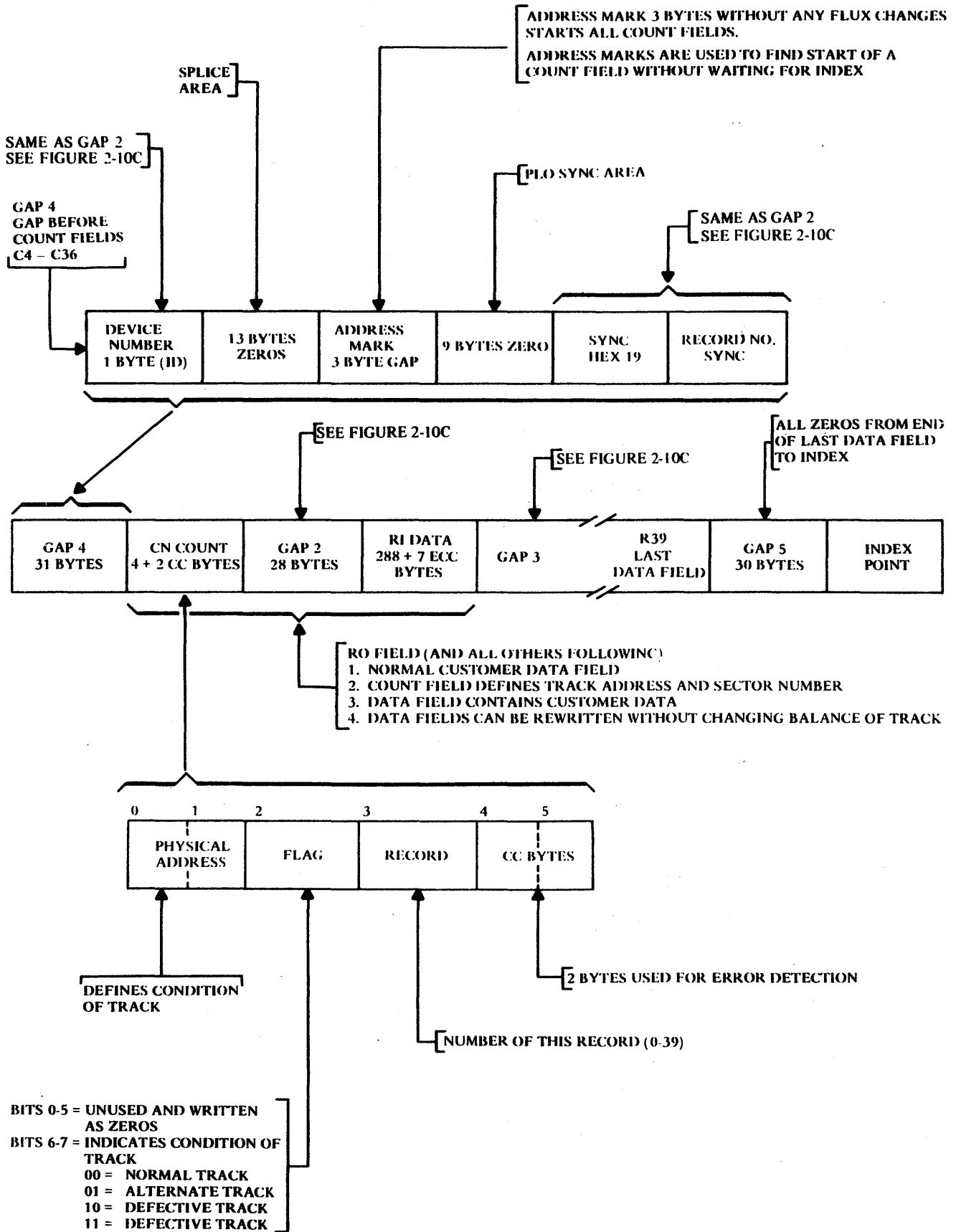

Figure 2-10D. CN Count Field

INSTRUCTION SET

The instruction set used with the DSS190 and DSS190B subsystem is shown in Table 2-3. The instruction codes are sent by the EUS to the DSC on the interface lines. Instructions special to the DSC are shown in Table 2-4. The special DSC instructions cannot be mixed with the normal instructions in the same channel program.

Instructions

SEEK

This instruction acquires the addressed disk pack cylinder for the logical channel issuing the instruction.

The Seek instruction format is five bytes (shown in Figure 2-11).

Sector Count Limit, Bits 0-11

These bits define the binary sector count. Bit position 11 is the least significant bit  $2^0$ . All zeros is a maximum count of 4096.

Track Indicator (TI), Bits 12-13

These bits indicate a complete track as good, defective, or alternate.

00 = Primary Track – Good

01 = Alternate Track – Good

10 = Defective Track – Alternate Track Assigned

11 = Defective Track – No Alternate Track Assigned

Sector Address, Bits 16-35

These bits define the specific binary sector address to be located on the addressed DSU. Bit position 35 is the least significant bit  $2^0$ .

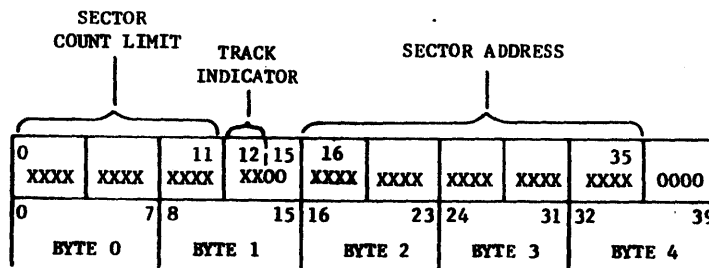

Figure 2-11. Seek Instruction Format

Table 2-3. Instruction Set

| FUNCTION  | BINARY CODE | VALID DEVICE CODE |
|---|-------------|-------------------|
| Seek  | 011100      | DSU Only          |
| Special Seek (T&D) <sup>a</sup>   | 011110      |                   |
| Preseek <sup>a</sup>  | 011111      |                   |
| Restore <sup>a</sup>  | 100010      |                   |
| Read  | 010101      |                   |
| Read ASCII  | 010011      |                   |
| Write   | 011001      |                   |
| Write ASCII   | 011010      |                   |
| Write and Compare   | 011011      |                   |
| Read Nonstandard Size   | 000100      |                   |
| Read Track Header <sup>a</sup>  | 010111      |                   |
| Format Track <sup>a</sup>   | 001111      |                   |
| Write Control Register <sup>a</sup>   | 001110      |                   |
| Release Device <sup>a</sup>   | 111110      |                   |
| Reserve Device <sup>a</sup>   | 111111      |                   |
| Set Standby <sup>a</sup>  | 111010      |                   |
| Execute Device <sup>a</sup>   | 011000      |                   |
| Execute MD Routine  | 110000      |                   |
| Read EDAC Register <sup>a</sup>   | 010001      |                   |
| Request Status  | 000000      | DSU or DSC        |
| Reset Status  | 100000      |                   |
| Read Control Register <sup>a</sup>  | 010110      |                   |
| Read Status Register <sup>a</sup>   | 010010      |                   |
| Bootload Control Store <sup>a</sup>   | 001000      | DSC Only          |
| ITR Boot <sup>a</sup>   | 001001      |                   |
| <sup>a</sup> Master Mode Instructions only; restricted to privileged users. |             |                   |

Table 2-4. Special Instruction Set

| INSTRUCTIONS  | BINARY CODE |
|---|-------------|
| Write Control Main Memory (BIN) <sup>a</sup>                                | 011010      |
| Write Control Main Memory (ASCII) <sup>a</sup>                              | 001010      |
| Conditional Write Lock Byte <sup>a</sup>                                    | 011100      |
| Write Lock Byte <sup>a</sup>  | 001100      |
| Read Control Main Memory (BIN) <sup>a</sup>                                 | 010010      |
| Read Control Main Memory (ASCII) <sup>a</sup>                               | 000010      |
| Read Lock Byte <sup>a</sup>   | 000100      |
| Initiate Write Data Transfer <sup>a</sup>                                   | 001110      |
| Initiate Read Data Transfer <sup>a</sup>                                    | 000110      |
| Suspend Control <sup>a</sup>  | 000000      |
| Release Control <sup>a</sup>  | 010000      |
| Send Special Interrupt <sup>a</sup>   | 001000      |
| Read Logical Channel Number <sup>a</sup>                                    | 011000      |
| <sup>a</sup> Master Mode Instructions only; restricted to privileged users. |             |

SPECIAL SEEK

This instruction is used for T & D. It is identical to the Seek instruction except that the sector address must reference a sector on cylinder 410.

PRESEEK

This instruction is like a Seek instruction except that it may not be followed by a data transfer instruction.

RESFCRE

This instruction reestablishes the seek reference point by returning the read/write heads of the selected DSU to cylinder zero.

READ

This instruction accesses data stored in the DSU and transfers it to the EUS.

READ ASCII

This instruction is the same as the Read instruction except that it indicates the American Standard Code for Information Interchange (ASCII) mode.

WRITE

This instruction transfers data from the EUS to the DSU for storage on the disk pack.

**WRITE ASCII**

This instruction is the same as the Write instruction except that it indicates the ASCII mode.

**WRITE AND COMPARE**

This instruction verifies the writing of data at the device.

**READ NONSTANDARD SIZE SECTOR**

This instruction is used to read all the fields on a sector of nonstandard size. The track format must be the same as for the DSU190/DSU190B format.

**READ TRACK HEADER**

This instruction transfers the home address and the record zero (R0) count and data fields of the required track to the EUS. The format of the data sent to the EUS is shown in Figure 2-12.

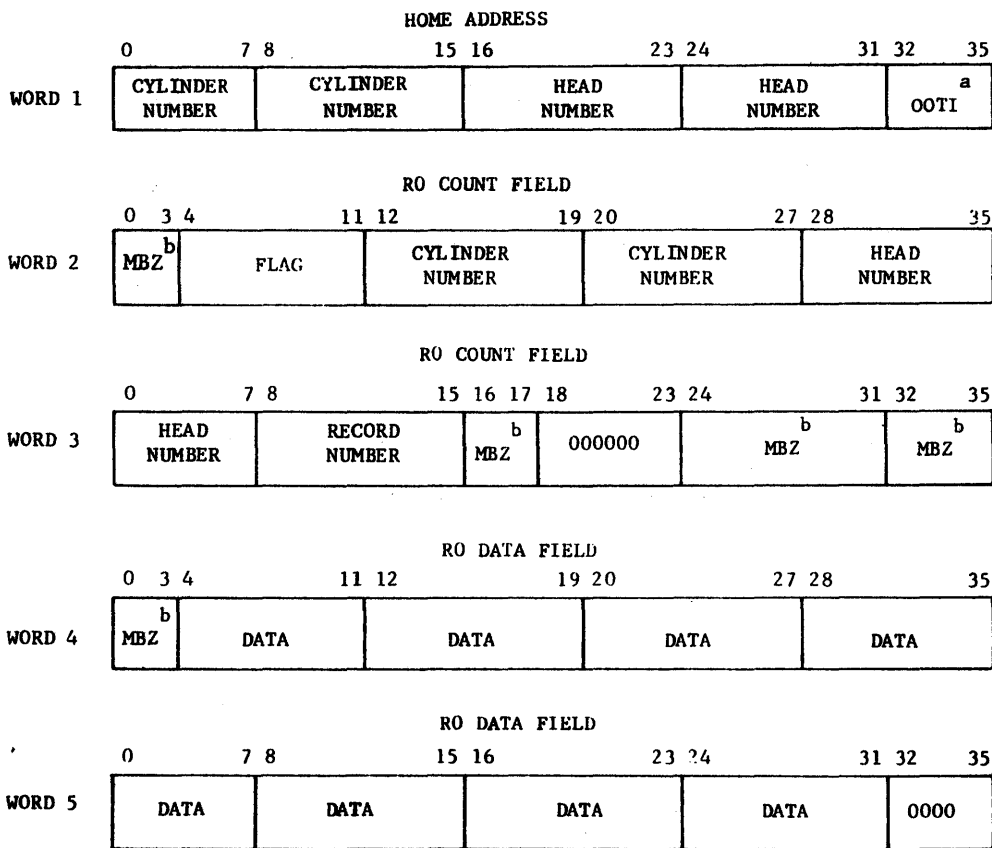

<sup>a</sup> Track Indicator  
<sup>b</sup> Must be zero

Figure 2-12. Track Header Format

## FORMAT TRACK

This instruction designates a complete track as good, defective, or alternate. It records all headers, address marks, gaps, and data fields on a given track, beginning at the index mark. The format of the data sent to the control is shown in Figure 2-13.

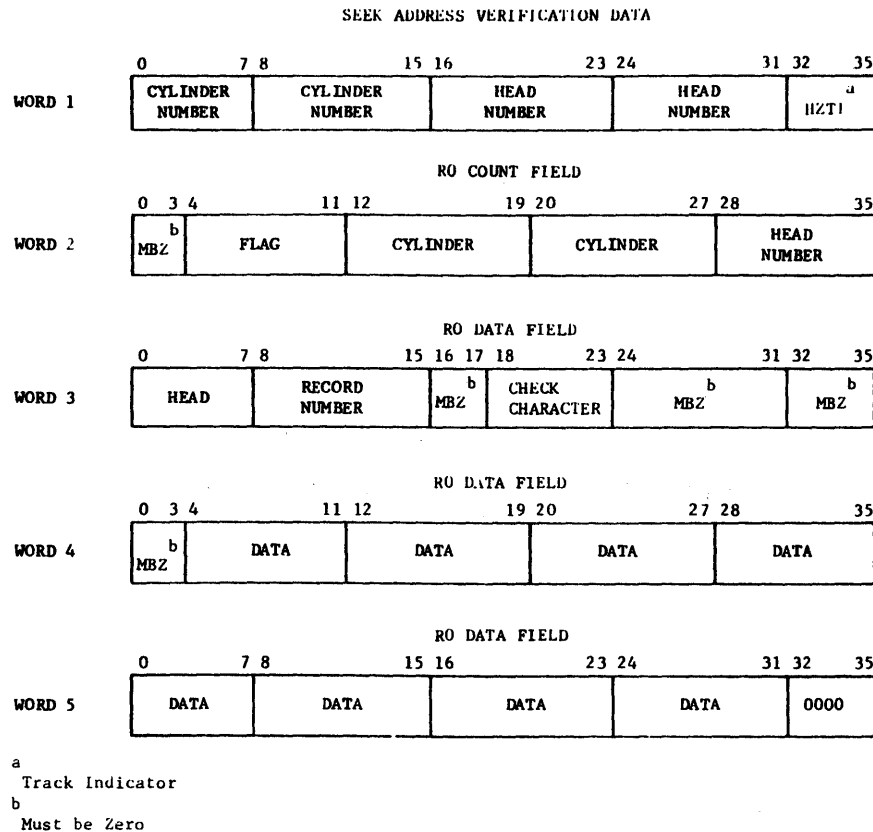

Figure 2-13. Format Track Data Format

## REQUEST STATUS

This instruction results in sending the control-held status (or the device-held status) for the last activity on the given logical channel to the EUS.

## RESET STATUS

This instruction resets any existing Data Alert, MPC Device Data Alert, and End-of-File major status held in the control for the given logical channel and returns to device-held status to the EUS. The invalid instruction sequence substatus also is reset.

## WRITE CONTROL REGISTER

This instruction allows clearing the statistics tallies or presetting some value into the tallies.

READ CONTROL REGISTER

This instruction supplies seek complete, seek incomplete, or device operation statistics to the EUS, and can be addressed to any legal device. If the instruction is addressed to the control (device zero), two 36-bit words are transferred to the EUS. The format for each word, depending on the subsystem configuration, is shown in Figure 2-14.

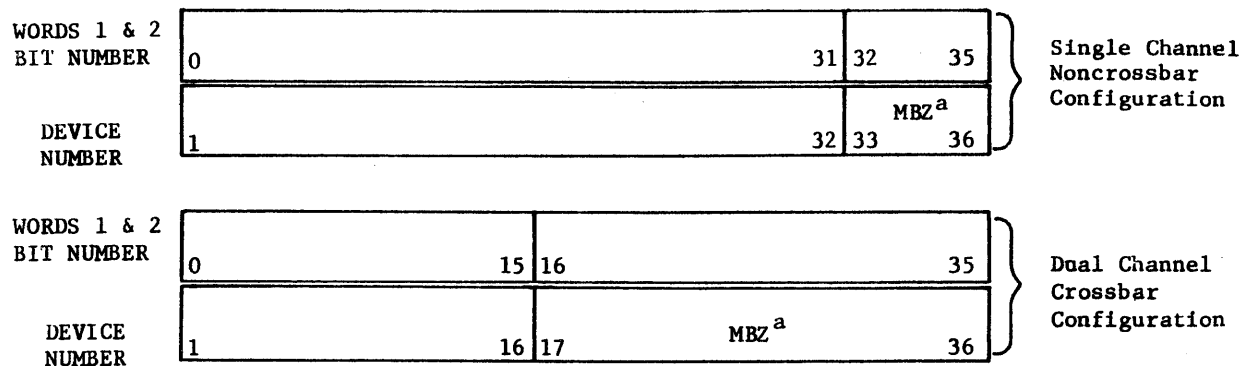

<sup>a</sup>  
Must be Zero

Figure 2-14. Read Control Register Format

For each device, by device number, word 1 provides seek complete information and word 2 provides device available information by the combination of corresponding bits in words 1 and 2:

| <u>Word 1</u> | <u>Word 2</u> |  |
|---------------|---------------|--|
| 0             | 0             | Device available; no information about seek complete.                  |
| 1             | 0             | Device available; seek complete.                                       |
| 0             | 1             | Device not available; busy positioning.                                |
| 1             | 1             | Device not available; seek incomplete, standby, offline, or attention. |

READ STATUS REGISTER

This instruction supplies the control status or the device status to the EUS.

RELEASE

This instruction releases a reserved device to the given logical channel.



#### READ EDAC REGISTER

This instruction is used to retrieve the error correction data, displacement, and sector number in error.

#### RESERVE DEVICE

This instruction explicitly reserves a device to a logical channel.

#### SET STANDBY

This instruction causes a device to go into a standby state.

#### BOOTLOAD CONTROL STORE

This instruction loads the microinstructions into the DSC control store.

#### ITR BOOT

This instruction loads the isolation test routine microprograms into the DSC control store.

#### EXECUTE DEVICE

This instruction transfers instructions, one instruction for each Execute Device instruction, directly from the EUS to the addressed device.

#### EXECUTE MICROCODED DEVICE (MD) ROUTINE

This instruction executes the MD routine in the control main memory.

NOTE: The instructions in the following paragraphs are special control instructions addressed to device zero. These instructions cannot be mixed with normal instructions in the same channel program.

#### WRITE CONTROL MAIN MEMORY, BINARY OR ASCII

These instructions are used to write either binary or ASCII format data from the EUS into the DSC memory.

#### READ CONTROL MAIN MEMORY, BINARY OR ASCII

These instructions are used to transfer binary or ASCII format data from the DSC to the EUS.

## CONDITIONAL WRITE LOCK BYTE, WRITE LOCK BYTE

These instructions provide a software lock capability in the DSC when the DSC is shared between two EUS.

## READ LOCK BYTE

This instruction reads the content of any one of the 256 lock bytes contained in the DSC memory.

## SUSPEND CONTROL

This instruction is used to seize the DSC by one EUS when the DSC is connected to more than one EUS via two or more physical channels.

## RELEASE CONTROL

This instruction resets the condition set by the Suspend Control instruction.

## SEND SPECIAL INTERRUPT

This instruction obtains data from the issuing EUS and uses this data for a special interrupt to be sent to all connected EUS, including the issuing EUS.

## READ LOGICAL CHANNEL NUMBER

This instruction sends the logical channel number, LA number, and the peripheral subsystem interface number to the EUS.

## Major Status and Substatus

Table 2-5 lists the possible status returns to the various instruction terminations. The major statuses and substatuses are described in detail.

## CHANNEL READY

The Channel Ready status indicates that the last instruction received has been completed and no detectable errors occurred.

## No Substatus

This status indicates that the controller or device is online and ready, and no detectable error conditions exist. When received at termination of a seek-type instruction, this substatus indicates that the online portion has been successfully completed. The controller is free to receive another instruction for that channel.

Table 2-5. Major Status and Substatus Codes

| STATUS                            | CODE   |
|-----------------------------------|--------|
| CHANNEL READY                     | 0000   |
| No Substatus                      | 000000 |
| Retries                           | 0000XX |
| Device in T&D                     | 0010XX |
| Data Corrected                    | 010000 |
| DEVICE BUSY                       | 0001   |
| Device Positioning                | 000000 |
| Alternate Channel in Control      | 100000 |
| ATTENTION                         | 0010   |
| Write Inhibit                     | 000001 |
| Seek Incomplete                   | 000010 |
| Device Inoperable                 | 001000 |
| Device in Standby                 | 010000 |
| Device Offline                    | 100000 |
| DATA ALERT                        | 0011   |
| Transfer Timing Alert             | 000001 |
| Transmission Parity Alert         | 000010 |
| Invalid Seek Address              | 000100 |
| Header Verification Failure       | 0X1000 |
| Check Character Alert             | X1X000 |
| Compare Alert                     | 1X0000 |
| END OF FILE                       | 0100   |
| Good Track Detected               | 000000 |
| Last Consecutive Block            | 0000X1 |
| Block Count Limit                 | 00001X |
| Defective Track, Alt. Assigned    | 000100 |
| Defective Track, No Alt. Assigned | 001000 |
| Alt. Track Detected               | 010000 |
| INSTRUCTION REJECTED              | 0101   |
| Invalid Operation Code            | 000001 |
| Invalid Device Code               | 000010 |
| Parity Alert on IDCW              | 000100 |
| Invalid Inst. Sequence            | 001000 |
| MPC DEVICE ATTENTION              | 1010   |
| Configuration Error               | 000001 |
| Multiple Devices                  | 000010 |
| Device Number Error               | 000011 |
| CA Error                          | 001011 |
| Alert EN-1                        | 001100 |
| CA EN-1 Error                     | 001101 |
| CA Alert No EN-1                  | 001110 |

Table 2-5 (cont). Major Status and Substatus Codes

| STATUS                         | CODE   |
|--------------------------------|--------|
| MPC DEVICE DATA ALERT          | 1011   |
| Transmission Parity Error      | 000001 |
| Inconsistent Command           | 000010 |
| Checksum Error                 | 000011 |
| Byte Lockout                   | 000100 |
| EDAC Parity Error              | 001110 |
| Sector Size Error              | 010001 |
| Nonstandard Sector Size        | 010010 |
| Search Alert "First"           | 010011 |
| Cyclic Code Error "Not First"  | 010100 |
| Search Alert "Not First"       | 010101 |
| Sync Byte Error                | 010110 |
| Alternate Track Error          | 010111 |
| EDAC Corr. - Last Sector       | 011001 |
| EDAC Corr. - Not Last Sector   | 011010 |
| EDAC Corr. - Block Count Limit | 011011 |
| EDAC Uncorrectable             | 011100 |
| EDAC Corr. Short Block         | 011101 |
| MPC COMMAND REJECT             | 1101   |
| Illegal Procedure              | 000001 |
| Illegal Logical Channel Number | 000010 |
| Illegal Suspend                | 000011 |
| Continue Bit Not Set           | 000100 |

**Retries**

When Automatic Retry is performed by the controller, the binary number coded in the substatus is the number of times the retry was performed:

Once (00X001)  
 Twice (00X010)  
 Three Times (00X011)

**Device in T & D Mode**

This substatus indicates that the device addressed was in the T&D mode.

**Data Corrected**

This substatus indicates that the control corrected data on the previous read instruction.

**DEVICE BUSY**

In response to an instruction, the Device Busy status indicates that the addressed storage unit temporarily is not available.

## Device Positioning

The addressed device was busy positioning. This substatus will be returned only for Request Status and Reset Status instructions.

## Alternate Channel in Control

This substatus is sent to the EUS attempting to gain control of the device or to a Release, Reserve Device, or Set Standby instruction directed to a device reserved by a different channel (dual channel operation).

## ATTENTION

The Attention status indicates a condition that may require manual intervention.

## Write Inhibit

This substatus is sent to the EUS when a write-type instruction is issued to a file that is write inhibited.

## Seek Incomplete

The access mechanism of the addressed device has failed to position after a determined period of time. The controller has attempted to correct the condition three times with Restore and Seek sequences.

## Device Inoperable

The device is online but is operating in a fault condition and must be investigated. The fault condition indicates the illegal combination of conditions within the device.

## Device in Standby

The device is in a standby state; that is, the spindle motor has been turned off and heads retracted.

## Device Offline

The addressed device is offline (power off) or not connected to the subsystem. The OPI line is down from the device.

## DATA ALERT

An error was detected during execution of the last instruction on that I/O channel. Any new instruction, except Request Status, will reset the Data Alert status.

### Transfer Timing Alert

A Transfer Timing Alert occurs when data is lost during data transfer because some hardware stage of the data transfer logic cannot keep up the transfer rate.

### Transmission Parity Alert

A parity error was detected by the MPC during the transmission of data bytes from the EUS, or transmission to or from the device.

### Invalid Seek Address

This substatus will occur if:

- A Special Seek was issued to a user cylinder
- A normal Seek instruction was issued to the T & D cylinder
- The Seek address exceeds the limit of one device
- The Format Track verification data does not match the Seek address
- Fewer than five bytes or more than five bytes are transferred as Seek data

This status also can occur when the check character test on the format instruction has a compare mismatch.

### Header Verification Failure

This status will be returned if the physical address bytes read from a count field do not match the address in the previous Seek address, or if an error occurs during the Format Track or Read Track Header instructions.

### Check Character Alert

The field cyclic check character generated in the CA did not match the one recorded on the media. This status will be set for check character failures, whether on a data field or the home address. If the cyclic check occurs on the data field, the status returned will be (010000). For Write and Compare operations, the status will be (110000) if, in addition to the cyclic check error on the data field, the compare operation failed, as well.

### Compare Alert

This substatus results from a Write and Compare instruction. It indicates that the data recorded does not match data received from the EUS.

### END OF FILE

The data transfer for the last instruction tried to exceed some defined boundary. This boundary may be a physical limit, the last block of an alternate track, or a program-imposed limit (for example, sector count limit).

#### Good Track Detected

The sector address in the count field is correct but the controller detected a "good" track indicator when it was expecting an alternate or defective track. This will occur only when the EUS has issued a Seek instruction to a track with "good" track indicators when it was expecting something else.

#### Last Consecutive Block

The last consecutive block of the addressed actuator position has been reached, the operation being executed has not been completed, and the channel instruction inhibits end-of-cylinder processing.

#### Block Count Limit

The total number of data sectors specified in the sector count limit were accessed, but the processing system has not issued a Terminate Out signal.

#### Defective Track Detected, Alternate Assigned

A read- or write-type instruction is attempted on a defective track, or overflow is assigned to a defective track and the channel instruction inhibits alternate track processing.

#### Defective Track Detected, No Alternate Assigned

This status is similar to the other Defective Track status, except that the track indicators are binary 11. This indicates that no alternate has been assigned to the defective track.

#### Alternate Track Detected

The sector address in the count field is correct but the controller detected an alternate track when a good or defective track was expected.

#### INSTRUCTION REJECTED

The Instruction Rejected status indicates that the instruction just received is not acceptable to the subsystem. The status is reset when any new instruction is received.

#### Invalid Operation Code

An operation code invalid for this subsystem was received.

### Invalid Device Code

No device with the given address is connected to the subsystem. If the device is connected but does not have power on, the status will be Attention Device Offline or a controller-only command (Bootload, Control Store, or ITR Boot) was received with a non-zero device code.

### Parity Alert on IDCW

A parity error was detected by the LA on the IDCW.

### Invalid Instruction Sequence

This condition occurs when the subsystem receives a data transfer instruction without a prior valid seek-type instruction on the same logical channel. Restore and Preseek are not valid instructions for data transfer.

### MPC DEVICE ATTENTION

MPC Device Attention status is an extension of the Attention status for all MPC controllers. It indicates an error condition that may require manual intervention.

### Configuration Error

This error condition will occur if the functionality firmware loaded into a controller does not agree with the configuration switches on the MPC operator panel.

### Multiple Devices

The controller has detected at least two devices with the same identification number.

### Device Number Error

At least one device has an identification number outside the range of legal device numbers for the subsystem.

### CA Error

The CA Operational In (OPI) line is down. (The OPI line indicates the operational state of the controller adapter.)

### Alert EN-1

The CA detected an abnormal condition during a data transfer. It was not a transfer timing or parity error.



#### CA EN-1 Error

The interrupt generated was not the interrupt that the controller was expecting from the CA.

#### CA Alert No EN-1

The controller commanded the CA to some action and no interrupt was generated (e. g. , CA terminal out).

#### MPC DEVICE DATA ALERT

The MPC Device Data Alert status is an expansion of the Data Alert for all MPC controllers. It indicates that an error was detected during execution of the last instruction on that I/O channel.

#### Transmission Parity Error

A transmission parity error was detected during the execution of a special controller instruction.

#### Inconsistent Command

Lock byte number specified is outside the lock byte area in the DSC.

#### Checksum Error

A checksum error on data was written to the MPC.

#### Byte Lockout

A Conditional Write Lock Byte instruction references a lock byte that is nonzero (locked).

#### EDAC Parity Error

An MPC hardware error was detected in the EDAC generation.

#### Sector Size Error

A Seek instruction was received with incorrect size bits, or the data field length read in the count field was not as specified in the previous Seek instruction.

#### Nonstandard Sector Size

An attempt was made to read on the disk a sector that was not a standard size for the Series 6000.

#### Search Alert "First Search"

A double index condition was detected (e.g., the controller could not find the desired sector number on the addressed track).

#### Cyclic Code Error "Not First Search"

The controller detected a cyclic code error on the count field read from the addressed track on a search after the first search (e.g., some data has been transferred).

#### Search Alert "Not First Search"

The controller could not find the desired sector number after the first search, or no count field was found after head switching (e.g., the controller found the first sector and transferred data, but could not find the second or subsequent count field).

#### Sync Byte Error

The synchronization byte read from the addressed track was not as expected.

#### Alternate Track Error

An error occurred in going to, processing, or returning from an alternate track.

#### EDAC Correction - Last Sector

A data error that may be correctable occurred in the last sector required (i.e., I/O was completed).

#### EDAC Correction - Not Last Sector

A data error that may be correctable has been detected and the I/O has not been completed (i.e., the IDCW tally has not run out).

#### EDAC Correction - Block Count Limit

A data error that may be correctable occurred in the last sector required (i.e., I/O was completed because one block count limit was exhausted).

#### EDAC Uncorrectable

A data error has been detected that is not correctable.

#### EDAC Correction – Short Block

A data error has been detected that may be correctable, but the error may have occurred outside the bounds of the required data transfer (i. e., the controller must read an entire sector but the I/O may have terminated before the error).

#### MPC COMMAND REJECT

MPC Command Reject status indicates that the instruction just received is not acceptable to the subsystem.

#### Illegal Procedure

A Write Control Main Memory command was received and the controller was not in suspend mode, or an initiate read (or write) data transfer IDCW was not preceded by a special controller command IDCW.

#### Illegal Logical Channel Number

An illegal logical channel number was received during an IDCW transfer.

#### Illegal Suspend

The controller is suspended and an IDCW is addressed to a logical channel other than the one over which the Suspend Control instruction is issued.

#### Continue Bit Not Set

The first IDCW of a two-IDCW command does not have the continue bit set (special controller commands).



### SECTION III OPERATING INSTRUCTIONS

#### SUBSYSTEM CONSIDERATIONS

This subsystem affords a high degree of subsystem effectiveness and data availability to the user. Data availability depends upon the ability to remove a disk pack from a failed disk pack drive and install it in an operating one. Reserve a disk pack drive as a spare so that disk pack drives can be tested and repaired while the rest of the subsystem is online.

NOTE: The DSS190 and DSS190B have been designed to operate with the M4050 Disk Pack. Equivalent disk packs conforming to the specifications of the M4050 Disk Pack may be used.

Data availability also requires the proper care, handling, and storage of the disk packs.

Disk pack identification and status labels should be affixed to the carrying case, never to the disk pack itself. Take care not to interchange disk packs and carrying cases to keep the information on the label (or listing) with the correct disk pack.

Bad or marginal track locations as found in manufacturing tests are noted on the disk pack carrying case labels or listings. Marginal tracks will degrade in a few months and should be treated as bad tracks. If more bad or marginal tracks develop, preserve this information in a file. Identify the disk pack by its serial number and list its bad or marginal tracks.

NOTE: Early versions of the disk pack may not have defective track information on the label or associated listings. In any case, defective track information is recorded on the disk pack and will be used by the startup and format programs. These tracks will be deallocated.

Occasionally, dust particles settle on a disk pack recording surface and get between the head and recording surface. The recording surface will be scratched by these particles and the disk pack surface slowly will deteriorate. An increasing number of read errors that can be recovered by the automatic retry program or the user retry option are evidence of deterioration. Establish a log of recoverable errors to evaluate trends of deteriorating performance.

Before recoverable errors become nonrecoverable, you should declare the suspect track defective and relocate its data to an alternate track. If more than a single error occurs on a track within one week, copy the entire disk pack onto another preformatted disk pack, or declare the track defective and redistribute the data on the disk pack.

When a nonrecoverable read error occurs, do not relocate the data to an alternate track, or declare the track defective. Instead, restore the data to the user file affected. An alternative is to move the disk pack to another disk pack drive and retry the operation. If this procedure fails, reconstruct either the disk pack or the user file.

It is also possible to get errors during a write operation. In these cases, alternate tracks should be assigned.

In disk storage unit operations, momentary contact of heads and recording surfaces is normal. Therefore, surface markings on the recording surfaces can be ignored unless they are accompanied by operational problems.

## SUBSYSTEM CONTROLS AND INDICATORS

Controls and indicators for the subsystem consist of operating, configuration, and maintenance switches and operational status display lamps. Operating controls and indicators are used during the normal operations of the subsystem and are easily accessible and visible to operations personnel. Operating controls and indicators are located on the DSC operator panel and the DSU operator panel. Configuration switches are set only during the initial installation or reconfiguration of the subsystem. To prevent changing these switches during normal subsystem operation, they are not easily accessible. The maintenance switches and indicators are for the exclusive use of the service engineer for offline maintenance. They, also, are not easily accessible. Only normal operating controls and indicators are described in this manual.

### DSC Operating Controls and Indicators

The DSC operator control panel contains the switches and indicators required for normal operation of the DSC (see Figure 3-1). The color coded indicators display the operating status of the DSC.

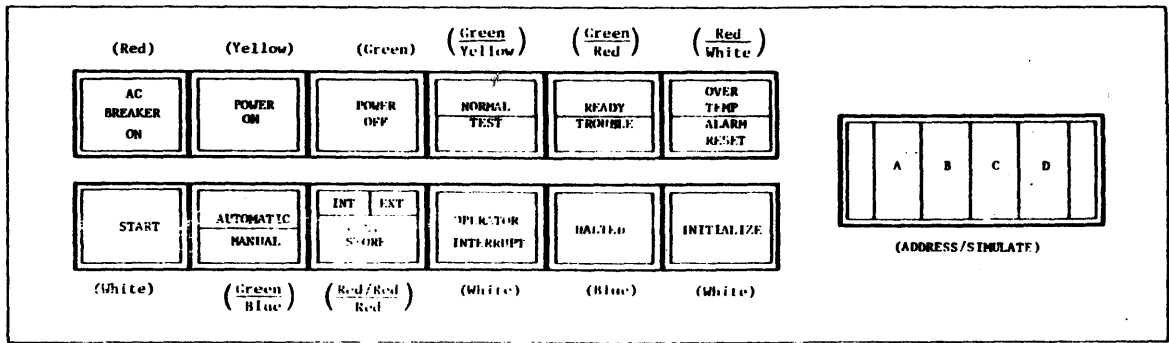

Figure 3-1. DSC Operating Controls and Indicators (Freestanding Control)

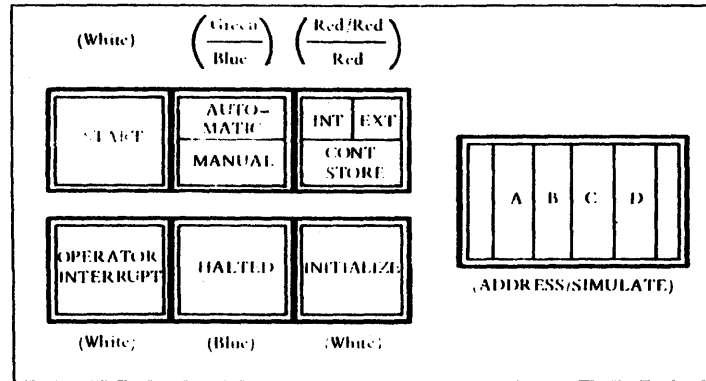

Figure 3-2. Operating Controls and Indicators (Control Integrated in ICU)

### AC BREAKER ON

This indicator lights red when the DSC cabinet primary branch service power circuit breaker is on and power is being applied to the DSC from the EUS power source panel.

NOTE: The DSC cabinet circuit breaker is located behind the right front door at the bottom right side of the cabinet on the circuit panel. This circuit breaker applies primary service power to the DSC and protects the DSC from overloading.

### POWER ON

Pressing this switch when ac power is on (AC BREAKER ON indicator lighted) turns the DSC cabinet dc power on. The POWER ON indicator lights yellow and the POWER OFF indicator goes out.

### POWER OFF

Pressing the switch when dc power is on turns the dc power off. The POWER OFF indicator lights green and the POWER ON indicator goes out.

## NORMAL/TEST

This split-field indicator defines the state (green = NORMAL, yellow = TEST) of the MAINT PANEL MODE NORMAL/TEST switch located on the TEST area of the maintenance panel. The switch must be in the NORMAL position for DSC operation.

NOTE: The maintenance panel is concealed behind the cover surrounding the operator panel. If the switch is in the TEST position, the operator may open the cover and reset the switch to NORMAL.

## READY/TROUBLE

This split-field indicator shows the operational state (green = READY, red = TROUBLE) of the DSC.

NOTE: The TROUBLE state occurs when the HALTED indicator is on or when the OPERATIONAL MODE OFFLINE/ONLINE switch (located on the TEST area of the maintenance panel) is set to OFFLINE. If the HALTED indicator is on, the operator may attempt to set the DSC to the READY state by using the START switch. If the DSC does not leave the halt state, the operator may open the maintenance panel cover and reset the OPERATIONAL MODE OFFLINE/ONLINE switch to ONLINE if needed. If the trouble persists, notify the local Honeywell field service engineer.

## OVER TEMP/ALARM RESET

This split-field indicator lights red in the OVER TEMP field and white in the ALARM RESET field. The DSC audible alarm sounds if the DSC cabinet is too hot. Pressing the switch turns off both the audible alarm and the white ALARM RESET field. The operator should press the POWER OFF switch and wait for the cabinet to cool. If the OVER TEMP field stays lighted, notify the local Honeywell field service engineer.

## START

Pressing this switch when the DSC is in the HALTED state changes the DSC from the TROUBLE to the READY state (see READY/TROUBLE indicator) and the indicator lights white.

## AUTOMATIC/MANUAL

This split-field shows the operational mode (green = AUTOMATIC, blue = MANUAL) of the DSC. This switch allows operator control over the execution of the initialize and halt options of the microprogram. These options are logically inhibited in the AUTOMATIC mode. Pressing this switch changes the state of the switch to the alternate state.



## INT/EXT/CONT STORE

This three-way split-field indicator lights red in an individual field when an error is detected. Pressing this switch or executing the error option of the microprogram should reset the error and turn off the indicator field. If the error persists, notify the Honeywell field service engineer.

## OPERATOR INTERRUPT

Pressing this switch lights the indicator white and causes the information stored in the ADDRESS/SIMULATE switches to be sent to the EUS as status for a special interrupt. The operator interrupt state is reset by the microprogram and the indicator goes out automatically.

## HALTED

This indicator lights blue when the DSC goes into the halt state.

## INITIALIZE

Pressing this switch lights the HALTED indicator and resets the DSC to the initialized state. The indicator lights white.

## ADDRESS/SIMULATE

These four thumbwheel switches are used in conjunction with the OPERATOR INTERRUPT switch to permit the user to address various functions of the DSC. The desired setting depends upon the specific application required. In conjunction with the maintenance panel these switches are used for diagnosing the DSC. Care should be taken not to change these switches while they are being sensed by the microprogram, since an error could result.

## Control Configuration Switches

These switches consist of 16 MICROPROGRAM READABLE switches, 0-15 (see Figure 3-3). The switches for the freestanding model are located behind the swing-down panel of the operator panel; those of the model integrated in the ICU are located on the maintenance panel behind the ICU right front narrow door. The switches are set by the Honeywell field engineer for proper operation of the subsystem and should not be disturbed by the operator. The only switches the operator may need to use in case of subsystem reconfiguration are switches 2, 8, 9 and 10 (see Table 3-1).

**CONFIGURATION**

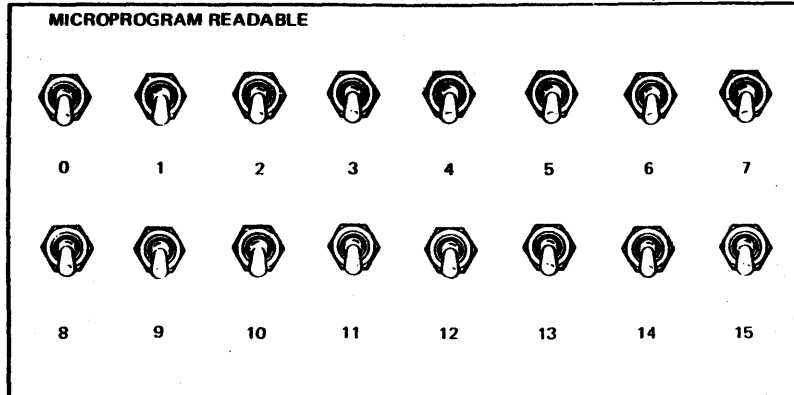

**Figure 3-3. Control Configuration Switches**

**Table 3-1. Control Configuration Switches**

| Switch Function                   | Switch Number | Switch Setting   |                    |
|-----------------------------------|---------------|--|--------------------|
|                                   |               | Normal <sup>a</sup>  | Other              |
| Basic Logic Test (BLT)            | 0             | Down (Execute BLT)   | Up (Bypass BLT)    |
| BLT Loop Control                  | 1             | Down (No Loop in BLT)                                      | Up (Loop on BLT)   |
| Select LA Port for Boot           | 2             | Down (LA Port 2)   | Up (LA Port 3)     |
| Number of LAs in Subsystem        | 3             | Down (Port 2)  | Up (Ports 2 and 3) |
| Interval Timer Runout (ITRO)      | 4             | Down (Enable ITRO)   | Up (Inhibit ITRO)  |
| Unassigned                        | 5, 6          | Down, Down   | (Not applicable)   |
| Rotational Position Sensing (RPS) | 7             | Down (Disable)   | Up (Enable)        |
| Control Configuration             | 8, 9, 10      | Down, Down, Down<br>(Non-Crossbar)                         | (Not applicable)   |
|                                   |               | Down, Down, Up<br>(Crossbar)                               |                    |
|                                   |               | Up, Down, Down<br>(Dual Control<br>as seen by<br>Software) |                    |
| Automatic Retry (AR)              | 11            | Down (Enable AR)   | Up (Disable AR)    |
| Unassigned                        | 12, 13        | Down, Down   | (Not applicable)   |
| Error Interrupt (EI)              | 14            | Down (Bypass ITR)  | Up (Branch to ITR) |
| Factory Test (FT) only            | 15            | Down (Bypass FT)   | Up (Factory Test)  |

<sup>a</sup>Unless set otherwise by Honeywell field engineer.

DSU190 Operating Controls and Indicators

The DSU190 operator panel contains the switches and indicators required for normal operation of the DSU (see Figure 3-4). The color coded indicators display the operating status of the DSU190. Table 3-2 presents the functions of the operator panel switches and indicators.

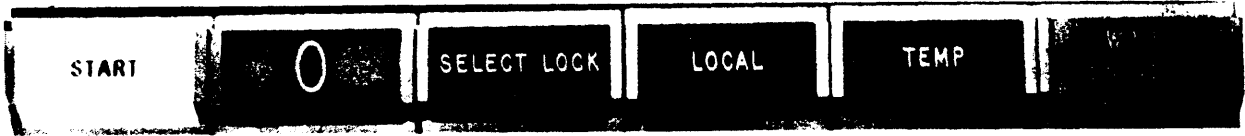

Figure 3-4. DSU190 Operating Control and Indicators

DSU190B Operating Controls and Indicators

The DSU190B operator panel, containing the required switches and indicators for normal operation, is shown in Figure 3-5. Table 3-3 presents the functions of the operator panel switches and indicators.

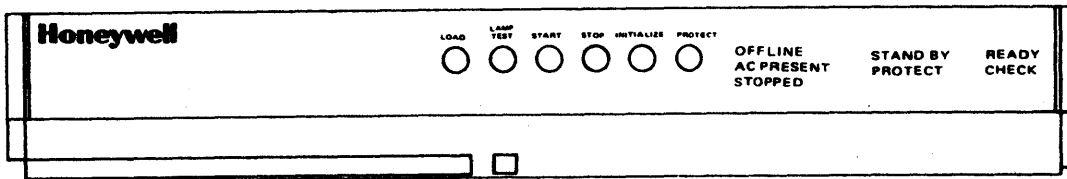

Figure 3-5. DSU190B Operating Controls and Indicators

Table 3-2. DSU190 Controls and Indicators

| CONTROL OR INDICATOR   | FUNCTION  |
|------------------------|---|
| START switch/indicator | <p>Energizes spindle drive motor and begins the First Seek sequence provided the following conditions are met:</p> <ol style="list-style-type: none"> <li>1. Disk pack is in place and canister removed.</li> <li>2. Front and top covers are closed.</li> <li>3. Circuit breakers are on.</li> <li>4. START switch is pressed.</li> </ol> <p>Any of the following conditions will extinguish the indicator and start a power off sequence:</p> <ol style="list-style-type: none"> <li>1. START switch pressed</li> <li>2. SSS command from controller</li> <li>3. Any cover interlock opens</li> <li>4. Any dc circuit breaker trips</li> <li>5. Loss of -16V emergency retract power</li> </ol> |

Table 3-2 (cont). DSU190 Controls and Indicators

| CONTROL OR INDICATOR               | FUNCTION  |
|------------------------------------|---|
| Unit Number Indicator              | Lights when the heads are loaded, indicating which unit is online. Unit numbers are installed by installation personnel and should not be changed.  |
| SELECT LOCK switch/<br>indicator   | <p>Lights when one or more of the following fault conditions occur:</p> <ol style="list-style-type: none"> <li>1. Read or Write is selected without an On Cylinder signal</li> <li>2. Low voltage (+5V, +20V, or -16V) signal</li> <li>3. Read and Write are selected at the same time</li> <li>4. Servo digits lost for more than 200 milliseconds (heads automatically unload)</li> <li>5. More than one head is selected</li> <li>6. Head Register contains number exceeding 18 (No Head Select)</li> <li>7. Write command without write current</li> <li>8. Write current without Write command</li> <li>9. Write current without write data</li> </ol> <p>Conditions 5 through 9 are known as current faults. They are inhibited while writing address marks.</p> <p>All conditions require that the SELECT LOCK switch be pressed or that the controller issue a DIN.</p> |
| LOCAL indicator                    | <p>Lights when drive experiences either of the following conditions:</p> <ol style="list-style-type: none"> <li>1. Controller issues an SLS command.</li> <li>2. ONLINE switch on logic chassis maintenance panel set to either OFFLINE position.</li> </ol>  |
| TEMP indicator                     | Lights when air flow is restricted enough to cause potential overheating. If air flow is less than about 150 fpm past either switch, indicator will light. One switch is located next to the intake of the logic fan that cools +5V regulator. The second switch is located at the intake of the power supply fan that cools the power amplifier board.   |
| WRITE PROTECT switch/<br>indicator | Inhibits all write operations. Any subsequent WRT or WRT TEST command will set State Violation (DSB1, Bit 2 <sup>3</sup> ).   |

Table 3-3. DSU190B Controls and Indicators

| CONTROL OR INDICATOR | FUNCTION  |
|----------------------|---|
| START switch         | Starts spindle rotation and causes device to go from standby to ready state. Switch will not work when cover is open.   |
| STOP switch          | Stops spindle rotation and changes device from ready to standby state.  |
| INITIALIZE switch    | Puts device in available substate. Resets all operational and status registers. Switch does not work when device is in ready state or after a positioner emergency retract. |
| PROTECT switch       | Inhibits or enables write operation.  |
| LAMP TEST switch     | Lights all indicator lamps. Works in standby state only.  |
| LOAD switch          | Momentarily depressing switch open or closes cover. Switch will not work while the spindle is rotating.   |
| READY indicator      | Indicates that the device is in the ready state.  |
| STANDBY indicator    | Indicates that the device is in the standby state. Indicator lights when STOP switch has been pressed.  |
| STOPPED indicator    | Lights when disk pack rotation has stopped, indicating that cover door may be opened.   |
| OFFLINE indicator    | Indicates that device is powered up, but in the offline state.  |
| CHECK indicator      | Indicates a device fault condition. Latch indicator must be reset by INITIALIZE switch.   |
| PROTECT indicator    | Indicates that the write operation has been inhibited by pressing the PROTECT switch or by detecting a fault condition.   |
| AC PRESENT indicator | Indicates the presence of primary power.  |
| POWER ON/OFF switch  | Controls the device primary power, but not the convenience outlet. Located behind the front door of the device.   |

**SUBSYSTEM OPERATION**

The subsystem operates in the EUS environment with the System Console, the Card Reader and Printer Subsystems, the Input/Output Multiplexer, and/or the DATANET 355 Front-End Network Processor. For operation of the subsystem in conjunction with the EUS, refer to the document list located in the preface.

Since operation of the subsystem is under control of the EUS program, the main concern of the subsystem operator is to provide a high degree of data availability to the EUS by:

- Keeping the subsystem ready and running
- Assuring that the proper disk packs are correctly installed

- Exchanging disk packs when requested or when a disk pack drive fails
- Releasing a device to exchange disk packs if a spare is not available when the failure or the exchange is requested
- Monitoring for and resolving temporary alert conditions
- Notifying the local Honeywell field service engineer when alerts or malfunctions cannot be resolved readily
- Starting and stopping the DSC and devices when required
- Keeping the equipment and area clean
- Handling and maintaining the disk packs properly
- Performing emergency procedures if required

### DSC Operation

DSC operation consists of turning cabinet power on and off when required; monitoring the various indicators for operational status, correcting any temporary error or malfunction halts, and initializing and starting the DSC. For more information refer to DSC Operating Controls and Indicators.

### DSU Operation

DSU operation consists of turning cabinet power on and off when required; monitoring the various indicators for operational status; correcting temporary alert conditions; restricting a DSU to read-only operations when required; stopping and starting the disk drive and installing or changing disk packs when requested or needed (refer to DSU Operating Controls and Indicators).

### DSU190 INITIALIZATION

Perform the following procedure to initialize a DSU190 (only).

1. Locate the ONLINE rotary switch. It is the third switch from the left on the maintenance panel inside the logic chassis door.
2. Set the ONLINE rotary switch to the OFFLINE position; then turn back to the ONLINE position.

NOTE: Switching from OFFLINE to ONLINE positions causes general reset.

### DSU190 DISK PACK INSTALLATION

Make certain that the disk pack to be installed has been cleaned and maintained properly.

1. Raise drive front cover.

NOTE: A spindle lock mechanism (ratchet brake) actuated when the front cover is opened holds the spindle stationary while a disk pack is loaded.

2. Lift the disk pack by the plastic canister handle.
3. Disengage the bottom dust cover from the disk pack using the latch in the center of the cover. Set the cover aside to a dust-free storage area.  

CAUTION: Avoid abusive contact between the disk pack and the spindle. During maintenance procedures the read/write heads sometimes are positioned manually. Make certain that the heads are fully retracted.
4. Place the disk pack onto the spindle.
5. Twist the canister handle clockwise until the slip clutch resists further twisting. The pack is now locked in place.
6. Lift the canister clear of the disk pack and set it on the bottom dust cover.
7. Close the front cover immediately to prevent dust from getting in and contaminating the disk surfaces.

#### DSU190 DISK PACK REMOVAL

1. Extinguish the operator panel START switch by pressing it.
2. Wait until disk pack has completely stopped rotating.  

CAUTION: A spindle lock mechanism engages when the front cover is opened. When a spinning drive is opened there is a loud ratcheting noise. This will not damage the unit, but it is not recommended.
3. Raise the front cover.  

CAUTION: During maintenance procedures the read/write heads sometimes are positioned manually. Make certain that the heads are fully retracted.
4. Place the plastic canister over the mounted disk pack so that the post protruding from the center of the disk pack is received into the canister handle.  

CAUTION: Avoid abusive contact between the disk pack and the spindle assembly.
5. Twist the canister handle counterclockwise until the disk pack is free of the spindle.
6. Lift the canister and the disk pack clear of the spindle.
7. Close the front cover.
8. Place the bottom dust cover in position on the disk pack and latch.
9. Store the disk pack flat, resting on its bottom cover, in a clean cabinet or on a clean shelf.

#### DSU190B INITIALIZATION

To initialize a DSU190B press the INITIALIZE switch to reset all operational and status registers. The INITIALIZE switch will not work when the DSU is in a ready state or after a positioner emergency retract.

## DSU190B DISK PACK INSTALLATION

Make certain that the disk pack to be installed has been cleaned and maintained properly.

1. Verify that the STOPPED indicator is lighted.

**CAUTION:** No attempt should be made to open the cover manually at any time. The cover is disabled and the LOAD switch will not work while the pack is rotating. The LOAD switch becomes effective only after the STOPPED indicator lights. See Table 3-3.

2. Press the LOAD switch to open the cover.

**NOTE:** The DSU190B disk drive was designed for pack loading directly into the front of the unit. Do not attempt to position the pack on the spindle by lowering the pack from the top of the unit.

3. Lift the disk pack by the plastic canister handle.
4. Disengage the bottom dust cover from the disk pack using the knob in the center of the cover. Set the cover aside to a dust-free storage area.

**CAUTION:** Avoid abusive contact between the disk pack and the spindle. During maintenance procedures the read/write heads sometimes are positioned manually. Make certain that the heads are fully retracted.

5. Place the disk pack onto the spindle.
6. Twist the canister handle clockwise until the slip clutch resists further twisting. The pack is now locked in place.
7. Lift the canister clear of the disk pack and set it on the bottom of the dust cover.
8. Close the front cover immediately to prevent dust from getting in and contaminating the disk surfaces.

## DSU190B DISK PACK REMOVAL

1. Press the STOP switch to stop spindle and pack rotation. Wait for the STOPPED indicator to light.

2. After the STOPPED indicator lights, press the LOAD switch to open the cover.

**CAUTION:** During maintenance procedures the read/write heads sometimes are positioned manually. Make certain that the heads are fully retracted.

3. Place the plastic canister over the mounted disk pack so that the post protruding from the center of the disk pack is received into the canister handle.

**CAUTION:** Avoid abusive contact between the disk pack and the spindle assembly.

4. Twist the canister handle counterclockwise until the disk pack is free of the spindle.
5. Lift the canister and the disk pack clear of the spindle.
6. Press the LOAD switch to close the front cover.
7. Place the bottom dust cover in position on the disk pack and tighten it.
8. Store the disk pack in a clean cabinet or on a clean shelf.



## Emergency Operation

Operations personnel should be thoroughly familiar with procedures for protecting people and equipment if an emergency occurs. The general emergency procedure is to turn off power at the affected unit. Power may be turned off at the affected unit, at the operator panel, at the circuit breaker on the rear of the unit, or at the building circuit breaker, depending on the severity of the emergency. Emergencies that can arise are mechanical, electrical, or overheating malfunction of a unit; outside primary power failure; air-conditioning failure; fire; flooding. In case of other unexpected conditions, take action appropriate for the type of emergency.

## SUBSYSTEM MAINTENANCE

The Honeywell field service engineer will perform all the maintenance required by the subsystem except for the routine cleaning of the DSC, DSU, and disk packs. This should be done by operations personnel.

### DSC/DSU Maintenance

Operations personnel should keep the DSC and DSU cabinets clean and free of dust. The DSU disk pack chamber and spindle may be cleaned with a lint-free tissue lightly dampened with approved cleaning alcohol.

### Disk Pack Maintenance

Proper handling, storing, and cleaning of disk packs is important to give users a high degree of data availability.

## HANDLING THE DISK PACK

- Always keep a disk pack in its carrying case, whenever it is not on a disk pack drive.
- The bottom cover of the disk pack carrying case may be removed easily by squeezing the latch on the bottom cover; the top cover is designed so that it cannot be removed until the disk pack is mounted on the spindle.
- Always reassemble the disk pack carrying case covers even when the disk pack is not inside.
- Never touch disk pack recording surfaces or the spindle mating surface with anything.
- Do not expose a disk pack to stray magnetic fields, excessive pressure, or sharp impact.
- Return every disk pack to its own carrying case.

## STORING THE DISK PACK

- Never store a disk pack where temperature exceeds the limit of 60°-90°F. If the limit has been exceeded, keep the disk pack in the operating room temperature for two hours before it is used.
- Store a disk pack in an environment identical to the disk pack drive operating environment.
- Never store a disk pack drive near strong magnetic fields, nor in direct sunlight.
- Store a disk pack flat, resting on its bottom cover. Never store a disk pack on edge.

\*

COMPUTER GENERATED INDEX

14  
 D55190 OR D55190B WITH 14 ADDITIONAL DEVICES AND TWO  
 SIMULTANEOUS CHANNELS. 2-2  
 16-DEVICE  
 16-DEVICE SUBSYSTEM. 1-1  
 AC  
 AC BREAKER ON. 3-3  
 ADDRESS  
 INVALID SEEK ADDRESS. 2-22  
 ADDRESS/SIMULATE  
 ADDRESS/SIMULATE. 3-5  
 ALERT  
 ALERT EN-1. 2-24  
 CA ALERT NO EN-1. 2-25  
 CHECK CHARACTER ALERT. 2-22  
 COMPARE ALERT. 2-22  
 MPC DEVICE DATA ALERT. 2-25  
 PARITY ALERT ON IDLE. 2-24  
 SEARCH ALERT "FIRST SEARCH". 2-26  
 SEARCH ALERT "NOT FIRST SEARCH". 2-26  
 TRANSFER TIMING ALERT. 2-22  
 TRANSMISSION PARITY ALERT. 2-22  
 ASCII  
 READ CONTROL MAIN MEMORY, BINARY OR ASCII. 2-17  
 WRITE CONTROL MAIN MEMORY, BINARY OR ASCII. 2-17  
 ATTENTION  
 ATTENTION. 2-21  
 MPC DEVICE ATTENTION. 2-24  
 BINARY  
 READ CONTROL MAIN MEMORY, BINARY OR ASCII. 2-17  
 WRITE CONTROL MAIN MEMORY, BINARY OR ASCII. 2-17  
 BLOCK  
 BLOCK COUNT LIMIT. 2-23  
 EDAC CORRECTION - BLOCK COUNT LIMIT. 2-26  
 EDAC CORRECTION - SHORT BLOCK. 2-26  
 LAST CONSECUTIVE BLOCK. 2-23  
 BOOT  
 ITR BOOT. 2-17  
 BOOTLOAD  
 BOOTLOAD CONTROL STORE. 2-17  
 BREAKER  
 AC BREAKER ON. 3-3  
 BYTE  
 BYTE LOCKOUT. 2-25  
 CONDITIONAL WRITE LOCK BYTE, WRITE LOCK BYTE. 2-18  
 READ LOCK BYTE. 2-18  
 SYNC BYTE ERROR. 2-26  
 CA  
 CA ALERT NO EN-1. 2-25  
 CA EN-1 ERROR. 2-25  
 CA ERROR. 2-24  
 CAPACITY  
 DISK PACK CAPACITY. 2-7  
 CHANNEL  
 ALTERNATE CHANNEL IN CONTROL. 2-21  
 D55190 OR D55190B WITH SIX ADDITIONAL DEVICES AND A  
 SWITCHED CHANNEL. 2-2  
 ILLEGAL LOGICAL CHANNEL NUMBER. 2-27  
 READ LOGICAL CHANNEL NUMBER. 2-18  
 TWO CONTROL DUAL CHANNEL CROSSBARRED SUBSYSTEM. 2-3  
 CHANNEL READY  
 CHANNEL READY. 2-18  
 CHANNELS  
 D55190 OR D55190B WITH 14 ADDITIONAL DEVICES AND TWO  
 SIMULTANEOUS CHANNELS. 2-2  
 DUAL CONTROL (TWO SINGLE CHANNELS) CROSSBARRED SUBSYSTEM  
 (DCX). 2-3  
 DUAL SUBSYSTEM WITH FOUR SIMULTANEOUS CHANNELS. 1-2  
 CHARACTER  
 CHECK CHARACTER ALERT. 2-22  
 CHARACTERISTICS  
 FUNCTIONAL CHARACTERISTICS OF THE DISK STORAGE UNIT.  
 2-5  
 CHECK  
 CHECK CHARACTER ALERT. 2-22  
 CHECKSUM  
 CHECKSUM ERROR. 2-25  
 CN COUNT  
 CN COUNT FIELD. 2-10.4  
 CO COUNT  
 CO COUNT FIELD. 2-10.2  
 CODE  
 CYCLIC CODE ERROR "NOT FIRST SEARCH". 2-26  
 INVALID DEVICE CODE. 2-24  
 INVALID OPERATION CODE. 2-23  
 MAJOR STATUS AND SUBSTATUS CODES. 2-19  
 COMMAND  
 INCONSISTENT COMMAND. 2-25  
 MPC COMMAND REJECT. 2-26  
 COMPARE  
 COMPARE ALERT. 2-22  
 WRITE AND COMPARE. 2-14  
 COMPONENT  
 COMPONENT FUNCTIONS. 2-1  
 SUBSYSTEM COMPONENTS. 1-3  
 CONFIGURATION  
 CONFIGURATION ERROR. 2-24  
 CONTROL CONFIGURATION SWITCHES. 3-5 3-5.1  
 SUBSYSTEM CONFIGURATION. 1-1  
 CONSECUTIVE  
 LAST CONSECUTIVE BLOCK. 2-23  
 CONSIDERATIONS  
 SUBSYSTEM CONSIDERATIONS. 3-1  
 CONTROL  
 ALTERNATE CHANNEL IN CONTROL. 2-21  
 BOOTLOAD CONTROL STORE. 2-17  
 CONTROL CONFIGURATION SWITCHES. 3-5 3-5.1  
 DISK STORAGE CONTROL (DSC). 1-3  
 DSC OPERATING CONTROLS AND INDICATORS (FREESTANDING  
 CONTROL). 3-3  
 DSC OPERATING CONTROLS AND INDICATORS. 3-2  
 DSU190 OPERATING CONTROLS AND INDICATORS. 3-5.2  
 DSU190B OPERATING CONTROLS AND INDICATORS. 3-5.2  
 DUAL CONTROL SUBSYSTEM. 1-2  
 DUAL CONTROL (TWO SINGLE CHANNELS) CROSSBARRED SUBSYSTEM  
 (DCX). 2-3  
 OPERATING CONTROLS AND INDICATORS (CONTROL INTEGRATED IN  
 ICU). 3-3  
 READ CONTROL MAIN MEMORY, BINARY OR ASCII. 2-17  
 READ CONTROL REGISTER. 2-16  
 RELEASE CONTROL. 2-18  
 SUBSYSTEM CONTROLS AND INDICATORS. 3-2  
 SUSPEND CONTROL. 2-18  
 TWO CONTROL DUAL CHANNEL CROSSBARRED SUBSYSTEM. 2-3  
 WRITE CONTROL MAIN MEMORY, BINARY OR ASCII. 2-17  
 WRITE CONTROL REGISTER. 2-15  
 CORRECTION  
 EDAC CORRECTION - BLOCK COUNT LIMIT. 2-26  
 EDAC CORRECTION - LAST SECTOR. 2-26  
 EDAC CORRECTION - NOT LAST SECTOR. 2-26  
 EDAC CORRECTION - SHORT BLOCK. 2-26  
 COUNT  
 BLOCK COUNT LIMIT. 2-23  
 EDAC CORRECTION - BLOCK COUNT LIMIT. 2-26  
 CYCLIC  
 CYCLIC CODE ERROR "NOT FIRST SEARCH". 2-26  
 DATA  
 DATA FIELDS. 2-10.3  
 MPC DEVICE DATA ALERT. 2-25  
 DATA ALERT  
 DATA ALERT. 2-21  
 DCA  
 DISK CONTROL ADAPTER (DCA). 2-4  
 DCX  
 DUAL CONTROL (TWO SINGLE CHANNELS) CROSSBARRED SUBSYSTEM  
 (DCX). 2-3  
 DEFECTIVE  
 DEFECTIVE TRACK DETECTED, ALTERNATE ASSIGNED. 2-23  
 DEFECTIVE TRACK DETECTED, NO ALTERNATE ASSIGNED. 2-23  
 DESCRIPTION  
 GENERAL DESCRIPTION. 1-1  
 DEVICE  
 DEVICE NUMBER ERROR. 2-24  
 DEVICE POSITIONING. 2-21  
 EXECUTE DEVICE. 2-17  
 EXECUTE MICROCODED DEVICE (MD) ROUTINE. 2-17  
 INVALID DEVICE CODE. 2-24  
 MPC DEVICE ATTENTION. 2-24  
 MPC DEVICE DATA ALERT. 2-25  
 RESERVE DEVICE. 2-17  
 DEVICE BUSY  
 DEVICE BUSY. 2-20  
 DEVICE IN STANDBY  
 DEVICE IN STANDBY. 2-21  
 DEVICE INOPERABLE  
 DEVICE INOPERABLE. 2-21  
 DEVICE OFFLINE  
 DEVICE OFFLINE. 2-21  
 DEVICES  
 D55190 OR D55190B WITH 14 ADDITIONAL DEVICES AND TWO  
 SIMULTANEOUS CHANNELS. 2-2  
 D55190 OR D55190B WITH SIX ADDITIONAL DEVICES AND A  
 SWITCHED CHANNEL. 2-2  
 MULTIPLE DEVICES. 2-24  
 DISK  
 DISK STORAGE CONTROL (DSC). 1-3  
 FUNCTIONAL CHARACTERISTICS OF THE DISK STORAGE UNIT.  
 2-5  
 DISK CONTROL ADAPTER  
 DISK CONTROL ADAPTER (DCA). 2-4  
 DISK PACK  
 CLEANING THE DISK PACK. 3-12  
 DISK PACK CAPACITY. 2-7  
 DISK PACK DRIVE DSU190B. 1-5

COMPUTER GENERATED INDEX

DISK PAK (CONT)  
 DISK PAK DRIVE DSJ190, 1-4  
 DISK PAK DRIVES, 1-4  
 DISK PAK MAINTENANCE, 3-11  
 DISK PAK RECORDING SURFACES, 2-6  
 DISK PAK, 1-5 1-6 2-5  
 USJ190 DISK PAK INSTALLATION, 3-8  
 USJ190 DISK PAK REMOVAL, 3-9  
 USJ190B DISK PAK INSTALLATION, 3-10  
 USJ190B DISK PAK REMOVAL, 3-10  
 HANDLING THE DISK PAK, 3-11  
 STORING THE DISK PAK, 3-12

DISK STORAGE CONTROL  
 DISK STORAGE CONTROL (DSC), 2-4

DISK STORAGE UNIT  
 DISK STORAGE UNIT (DSU), 2-4

DRIVE  
 DISK PAK DRIVE DSJ190B, 1-5  
 DISK PAK DRIVE DSJ190, 1-4  
 DISK PAK DRIVES, 1-4

DSC  
 DISK STORAGE CONTROL (DSC), 2-4  
 DISK STORAGE CONTROL (DSC), 1-3  
 DSC OPERATING CONTROLS AND INDICATORS (PRESTANDING CONTROL), 3-3  
 DSC OPERATING CONTROLS AND INDICATORS, 3-2  
 DSC OPERATION, 3-8

DSC/DSU  
 DSC/DSU MAINTENANCE, 3-11

DSS190  
 DSS190 OR DSS190B WITH 14 ADDITIONAL DEVICES AND TWO SIMULTANEOUS CHANNELS, 2-2  
 DSS190 OR DSS190B WITH SIX ADDITIONAL DEVICES AND A SWITCHED CHANNEL, 2-2

DSS190B  
 DSS190 OR DSS190B WITH 14 ADDITIONAL DEVICES AND TWO SIMULTANEOUS CHANNELS, 2-2  
 DSS190 OR DSS190B WITH SIX ADDITIONAL DEVICES AND A SWITCHED CHANNEL, 2-2

DSJ190  
 DISK PAK DRIVE DSJ190, 1-4  
 USJ190 DISK PAK INSTALLATION, 3-8  
 USJ190 DISK PAK REMOVAL, 3-9  
 USJ190 INITIALIZATION, 3-8  
 USJ190 OPERATING CONTROLS AND INDICATORS, 3-5.2

DSJ190B  
 DISK PAK DRIVE DSJ190B, 1-5  
 USJ190B DISK PAK INSTALLATION, 3-10  
 USJ190B DISK PAK REMOVAL, 3-10  
 USJ190B INITIALIZATION, 3-9  
 USJ190B OPERATING CONTROLS AND INDICATORS, 3-5.2

DSU  
 DISK STORAGE UNIT (DSU), 2-4  
 DSU OPERATION, 3-8

EDAC  
 EDAC CONNECTION - BLOCK COUNT LIMIT, 2-26  
 EDAC CONNECTION - LAST SECTOR, 2-26  
 EDAC CONNECTION - NOT LAST SECTOR, 2-26  
 EDAC CONNECTION - SMART BLOCK, 2-26  
 EDAC PARITY ERROR, 2-25  
 EDAC UNCONNECTABLE, 2-26  
 READ EDAC REGISTER, 2-17

EMERGENCY  
 EMERGENCY OPERATION, 3-11

END OF FILE  
 END OF FILE, 2-22

EN-1  
 ALERT EN-1, 2-24  
 CA ALERT NO EN-1, 2-25  
 CA EN-1 ERROR, 2-25

ERROR  
 ALTERNATE TRACK ERROR, 2-26  
 CA EN-1 ERROR, 2-25  
 CA ERROR, 2-24  
 CHECKSUM ERROR, 2-25  
 CONFIGURATION ERROR, 2-24  
 CYCLIC CODE ERROR "NOT FIRST SEARCH", 2-26  
 DEVICE NUMBER ERROR, 2-24  
 EDAC PARITY ERROR, 2-25  
 SECTOR SIZE ERROR, 2-25  
 SYNC BYTE ERROR, 2-26  
 TRANSMISSION PARITY ERROR, 2-25

FAILURE  
 HEADER VERIFICATION FAILURE, 2-22

FIELD  
 CN COUNT FIELD, 2-10.4  
 CO COUNT FIELD, 2-10.2  
 DATA FIELDS, 2-10.3  
 HOME ADDRESS FIELD, 2-8  
 RO FIELD, 2-9  
 RI FIELD, 2-10

FIRST SEARCH  
 FIRST SEARCH (CONT)  
 SEARCH ALERT "FIRST SEARCH", 2-26

FORMAT  
 BASIC TRACK FORMAT, 2-6 2-7  
 FORMAT TRACK, 2-15  
 SEEK INSTRUCTION FORMAT, 2-11  
 TRACK HEADER FORMAT, 2-14

FUNCTIONAL  
 FUNCTIONAL CHARACTERISTICS OF THE DISK STORAGE UNIT, 2-5

FUNCTIONAL DESCRIPTION  
 FUNCTIONAL DESCRIPTION, 2-1

FUNCTIONS  
 COMPONENT FUNCTIONS, 2-1

HALTED  
 HALTED, 3-5

HEADER  
 HEADER VERIFICATION FAILURE, 2-22  
 READ TRACK HEADER, 2-14  
 TRACK HEADER FORMAT, 2-14

HOME ADDRESS  
 HOME ADDRESS FIELD, 2-8

ICF  
 INCREASED CAPACITY FORMAT (ICF), 2-10.1

ICU  
 OPERATING CONTROLS AND INDICATORS (CONTROL INTEGRATED IN ICU), 3-3

IDCW  
 PARITY ALERT ON IDCW, 2-24

ILLEGAL  
 ILLEGAL LOGICAL CHANNEL NUMBER, 2-27  
 ILLEGAL PROCEDURE, 2-26  
 ILLEGAL SUSPEND, 2-27

INDICATORS  
 DSC OPERATING CONTROLS AND INDICATORS (PRESTANDING CONTROL), 3-3  
 DSC OPERATING CONTROLS AND INDICATORS, 3-2  
 DSJ190 OPERATING CONTROLS AND INDICATORS, 3-5.2  
 DSJ190B OPERATING CONTROLS AND INDICATORS, 3-5.2  
 OPERATING CONTROLS AND INDICATORS (CONTROL INTEGRATED IN ICU), 3-3  
 SUBSYSTEM CONTROLS AND INDICATORS, 3-2

INITIALIZATION  
 DSJ190 INITIALIZATION, 3-8  
 DSJ190B INITIALIZATION, 3-9

INITIALIZE  
 INITIALIZE, 3-5

INSTALLATION  
 DSJ190 DISK PAK INSTALLATION, 3-8  
 DSJ190B DISK PAK INSTALLATION, 3-10

INSTRUCTION  
 INSTRUCTION REJECTED, 2-23  
 INVALID INSTRUCTION SEQUENCE, 2-24  
 SEEK INSTRUCTION FORMAT, 2-11

INSTRUCTION SET  
 INSTRUCTION SET, 2-11 2-12  
 SPECIAL INSTRUCTION SET, 2-13

INSTRUCTIONS  
 INSTRUCTIONS, 2-11

INTEGRATED  
 OPERATING CONTROLS AND INDICATORS (CONTROL INTEGRATED IN ICU), 3-3

INTERRUPT  
 OPERATOR INTERRUPT, 3-5  
 SEND SPECIAL INTERRUPT, 2-18

INT/EXT/CONT  
 INT/EXT/CONT STORE, 3-4

ITR  
 ITR BOOT, 2-17

LA  
 LINK ADAPTER (LA), 2-4

LIMIT  
 BLOCK COUNT LIMIT, 2-23  
 EDAC CONNECTION - BLOCK COUNT LIMIT, 2-26

LINK ADAPTER  
 LINK ADAPTER (LA), 2-4

LOCK  
 CONDITIONAL WRITE LOCK BYTE, WRITE LOCK BYTE, 2-18  
 READ LOCK BYTE, 2-18

LOCKOUT  
 BYTE LOCKOUT, 2-25

LOGICAL  
 ILLEGAL LOGICAL CHANNEL NUMBER, 2-27  
 READ LOGICAL CHANNEL NUMBER, 2-18

MAINTENANCE  
 DISK PAK MAINTENANCE, 3-11  
 DSC/DSU MAINTENANCE, 3-11  
 SUBSYSTEM MAINTENANCE, 3-11

MD  
 EXECUTE MICROCODED DEVICE (MD) ROUTINE, 2-17

MEMORY  
 READ CONTROL MAIN MEMORY, BINARY OR ASCII, 2-17

COMPUTER GENERATED INDEX

MEMORY (CONT)  
 WRITE CONTROL MAIN MEMORY, BINARY OR ASCII. 2-17  
 MICROCODEV  
 EXECUTE MICROCODED DEVICE (MD) ROUTINE. 2-17  
 MPC  
 MPC COMMAND REJECT. 2-26  
 MPC DEVICE ATTENTION. 2-24  
 MPC DEVICE DATA ALERT. 2-25  
 MULTIPLE  
 MULTIPLE DEVICES. 2-24  
 NORMAL/TEST  
 NORMAL/TEST. 3-4  
 NOT FIRST SEARCH  
 CYCLIC CODE ERROR "NOT FIRST SEARCH". 2-26  
 SEARCH ALERT "NOT FIRST SEARCH". 2-26  
 OPERATION  
 DSC OPERATION. 3-8  
 DSU OPERATION. 3-8  
 EMERGENCY OPERATION. 3-11  
 INVALID OPERATION CODE. 2-23  
 SUBSYSTEM OPERATION. 3-7  
 OPERATOR  
 OPERATOR INTERRUPT. 3-5  
 OVEN TEMP/ALARM RESET  
 OVEN TEMP/ALARM RESET. 3-4  
 PARITY  
 EUAL PARITY ERROR. 2-25  
 PARITY ALERT ON IDCW. 2-24  
 TRANSMISSION PARITY ALERT. 2-22  
 TRANSMISSION PARITY ERROR. 2-25  
 POSITIONING  
 DEVICE POSITIONING. 2-21  
 POWER OFF  
 POWER OFF. 3-3  
 POWER ON  
 POWER ON. 3-3  
 PRESEEK  
 PRESEEK. 2-13  
 PROCEDURE  
 ILLEGAL PROCEDURE. 2-26  
 M0  
 M0 FIELD. 2-9  
 M1  
 M1 FIELD. 2-10  
 READ  
 READ CONTROL MAIN MEMORY, BINARY OR ASCII. 2-17  
 READ CONTROL REGISTER. 2-16  
 READ EUAL REGISTER. 2-17  
 READ LOCK BYTE. 2-18  
 READ LOGICAL CHANNEL NUMBER. 2-18  
 READ NONSTANDARD SIZE SECTOR. 2-14  
 READ STATUS REGISTER. 2-16  
 READ TRACK HEADER. 2-14  
 READ. 2-13  
 READ ASCII  
 READ ASCII. 2-13  
 READY/TROUBLE  
 READY/TROUBLE. 3-4  
 RECORDING  
 DISK PACK RECORDING SURFACES. 2-6  
 REGISTER  
 READ CONTROL REGISTER. 2-16  
 READ EUAL REGISTER. 2-17  
 READ STATUS REGISTER. 2-16  
 WRITE CONTROL REGISTER. 2-15  
 REJECT  
 INSTRUCTION REJECTED. 2-23  
 MPC COMMAND REJECT. 2-26  
 RELEASE  
 RELEASE CONTROL. 2-18  
 RELEASE. 2-16  
 REMOVAL  
 DSU190 DISK PACK REMOVAL. 3-9  
 DSU190B DISK PACK REMOVAL. 3-10  
 REQUEST  
 REQUEST STATUS. 2-15  
 RESERVE  
 RESERVE DEVICE. 2-17  
 RESET  
 RESET STATUS. 2-15  
 RESTORE  
 RESTORE. 2-13  
 ROUTINE  
 EXECUTE MICROCODED DEVICE (MD) ROUTINE. 2-17  
 SEARCH  
 SEARCH ALERT "FIRST SEARCH". 2-26  
 SEARCH ALERT "NOT FIRST SEARCH". 2-26  
 SECTOR  
 EUAL CORRECTION - LAST SECTOR. 2-26  
 EUAL CORRECTION - NOT LAST SECTOR. 2-26  
 NONSTANDARD SECTOR SIZE. 2-25  
 READ NONSTANDARD SIZE SECTOR. 2-14

SECTOR (CONT)  
 SECTOR SIZE ERROR. 2-25  
 SEEK  
 INVALID SEEK ADDRESS. 2-22  
 SEEK INSTRUCTION FORMAT. 2-11  
 SEEK. 2-11  
 SEEK INCOMPLETE  
 SEEK INCOMPLETE. 2-21  
 SEND  
 SEND SPECIAL INTERRUPT. 2-18  
 SEQUENCE  
 INVALID INSTRUCTION SEQUENCE. 2-24  
 SET  
 SET STANDBY. 2-17  
 SIMULTANEOUS  
 DSU190 OR DSU190B WITH 14 ADDITIONAL DEVICES AND TWO  
 SIMULTANEOUS CHANNELS. 2-2  
 DUAL SUBSYSTEM WITH FOUR SIMULTANEOUS CHANNELS. 1-2  
 SIZE  
 NONSTANDARD SECTOR SIZE. 2-25  
 READ NONSTANDARD SIZE SECTOR. 2-14  
 SECTOR SIZE ERROR. 2-25  
 STANDBY  
 SET STANDBY. 2-17  
 START  
 START. 3-4  
 STATUS  
 MAJOR STATUS AND SUBSTATUS CODES. 2-19  
 MAJOR STATUS AND SUBSTATUS. 2-18  
 READ STATUS REGISTER. 2-16  
 REQUEST STATUS. 2-15  
 RESET STATUS. 2-15  
 STORAGE  
 DISK STORAGE CONTROL (DSC). 1-3  
 FUNCTIONAL CHARACTERISTICS OF THE DISK STORAGE UNIT.  
 2-5  
 STORE  
 BOOTLOAD CONTROL STORE. 2-17  
 INT/EXT/CONT STORE. 3-4  
 SUBSTATUS  
 MAJOR STATUS AND SUBSTATUS CODES. 2-19  
 MAJOR STATUS AND SUBSTATUS. 2-18  
 SUBSYSTEM  
 16-DEVICE SUBSYSTEM. 1-1  
 BASIC SUBSYSTEM. 1-1  
 DUAL CONTROL SUBSYSTEM. 1-2  
 DUAL CONTROL (TWO SINGLE CHANNELS) CROSSBARRED SUBSYSTEM  
 (DCK). 2-3  
 DUAL SUBSYSTEM WITH FOUR SIMULTANEOUS CHANNELS. 1-2  
 SUBSYSTEM COMPONENTS. 1-3  
 SUBSYSTEM CONFIGURATION. 1-1  
 SUBSYSTEM CONSIDERATIONS. 3-1  
 SUBSYSTEM CONTROLS AND INDICATORS. 3-2  
 SUBSYSTEM MAINTENANCE. 3-11  
 SUBSYSTEM OPERATION. 3-7  
 TWO CONTROL DUAL CHANNEL CROSSBARRED SUBSYSTEM. 2-3  
 SURFACES  
 DISK PACK RECORDING SURFACES. 2-6  
 SUSPEND  
 ILLEGAL SUSPEND. 2-27  
 SUSPEND CONTROL. 2-18  
 SWITCHES  
 CONTROL CONFIGURATION SWITCHES. 3-5 3-5.1  
 SYNC  
 SYNC BYTE ERROR. 2-26  
 TIMING  
 TRANSFER TIMING ALERT. 2-22  
 TRACK  
 ALTERNATE TRACK DETECTED. 2-23  
 ALTERNATE TRACK ERROR. 2-26  
 BASIC TRACK FORMAT. 2-6 2-7  
 DEFECTIVE TRACK DETECTED, ALTERNATE ASSIGNED. 2-23  
 DEFECTIVE TRACK DETECTED, NO ALTERNATE ASSIGNED. 2-23  
 FORMAT TRACK. 2-15  
 GOOD TRACK DETECTED. 2-23  
 HEAD TRACK HEADER. 2-14  
 TRACK HEADER FORMAT. 2-14  
 TRANSFER  
 TRANSFER TIMING ALERT. 2-22  
 TRANSMISSION  
 TRANSMISSION PARITY ALERT. 2-22  
 TRANSMISSION PARITY ERROR. 2-25  
 UNCORRECTABLE  
 EDAC UNCORRECTABLE. 2-26  
 UNIT  
 FUNCTIONAL CHARACTERISTICS OF THE DISK STORAGE UNIT.  
 2-5  
 VERIFICATION  
 HEADER VERIFICATION FAILURE. 2-22  
 WRITE  
 CONDITIONAL WRITE LOCK BYTE, WRITE LOCK BYTE. 2-18  
 WRITE AND COMPARE. 2-14

COMPUTER GENERATED INDEX

WRITE (CONT)  
WRITE CONTROL MAIN MEMORY, BINARY OR ASCII. 2-17  
WRITE CONTROL REGISTER. 2-15  
WRITE. 2-13

WRITE (CONT)  
WRITE ASCII. 2-14  
WRITE INHIBIT  
WRITE INHIBIT. 2-21

**HONEYWELL INFORMATION SYSTEMS**  
**Publications Remarks Form\***

TITLE: **SERIES 6000 DSS190 AND DSS190B DISK  
STORAGE SUBSYSTEM REFERENCE MANUAL**

ORDER No.: **DB37, REV. 3**  
DATED: **JANUARY 1975**

**ERRORS IN PUBLICATION:**

[Empty box for reporting errors in publication]

**SUGGESTIONS FOR IMPROVEMENT TO PUBLICATION:**

[Empty box for providing suggestions for improvement to publication]

*(Please Print)*

FROM: NAME \_\_\_\_\_  
COMPANY \_\_\_\_\_  
TITLE \_\_\_\_\_  
\_\_\_\_\_  
\_\_\_\_\_

DATE: \_\_\_\_\_

CUT ALONG LINE

\*Your comments will be promptly investigated by appropriate technical personnel, action will be taken as required, and you will receive a written reply. If you do not require a written reply, please check here:

PLEASE FOLD AND TAPE—

NOTE: U. S. Postal Service will not deliver stapled forms.



NO POSTAGE  
NECESSARY  
IF MAILED  
IN THE  
UNITED STATES

**BUSINESS REPLY MAIL**

FIRST CLASS PERMIT NO. 39531 WALTHAM, MA 02154

POSTAGE WILL BE PAID BY ADDRESSEE

**HONEYWELL INFORMATION SYSTEMS**  
200 SMITH STREET  
WALTHAM, MA 02154

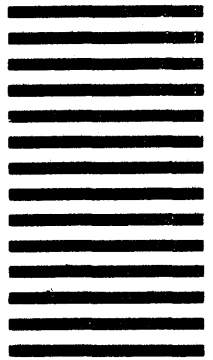

ATTN: PUBLICATIONS, MS486

**Honeywell**



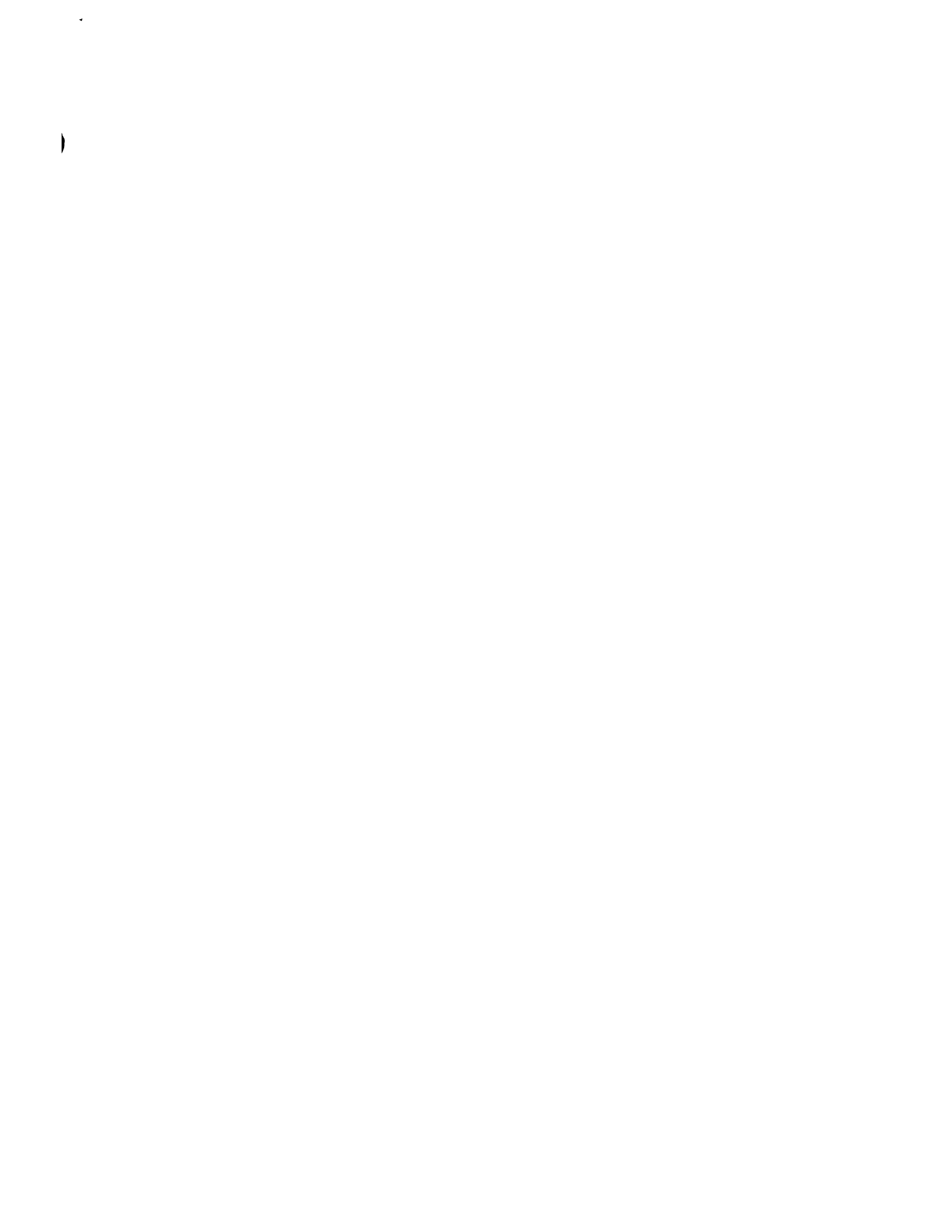

# Honeywell

## **Honeywell Information Systems**

In the U.S.A.: 200 Smith Street, MS 486, Waltham, Massachusetts 02154  
In Canada: 2025 Sheppard Avenue East, Willowdale, Ontario M2J 1W5  
In the U.K.: Great West Road, Brentford, Middlesex TW8 9DH  
In Australia: 124 Walker Street, North Sydney, N.S.W. 2060  
In Mexico: Avenida Nuevo Leon 250, Mexico 11, D.F.

30730, .5C381, Printed in U.S.A.

DB37, R