

1.0 General Description

The Datapoint 8200 Workstation is a general purpose, interactive CRT terminal. The display capacity is 24 lines of 80 characters each for a total of 1920 characters. The characters are formed by 5 by 7 dot matrices.

The 8200 Workstation transmits and receives serial data in ASCII format complying with EIA-RS-232-C data levels. The workstation operates in full- or half-duplex mode. The mode is configurable through the keyboard or through down-line loading by the Datapoint processor. Transmit and receive rates are independently configurable through the keyboard to a maximum of 9600 baud.

The 8200 can operate under Datapoint's multiuser business oriented language, DATASHARE[®], and as a compatible workstation in Datapoint's RMS[™] (Resource Management System[™]) operating environment.

Five types of terminal functions can be specified by the operator or down-line loaded by the host processor.

- **Operator Convenience Options**
The 8200 allows the operator to adjust permanent display brightness to any of sixteen levels while in the configuration mode. Also, a Double Key option allows certain function keys to act as extensions of their adjacent keys to prevent keying errors if experienced Datapoint 3600 operators use the 8200.

- **Communication Options**
The communication options permit the selection of various baud rates, selection of parity format (even or odd, 0 or 1), and the generation of ASCII control characters for transmission to the host processor as system keycodes.

- **Character Options**
The character options allow the operator to display additional characters, special character sets, or upper case character sets only. In addition, the 8200 supports a SHIFT key configuration which allows an

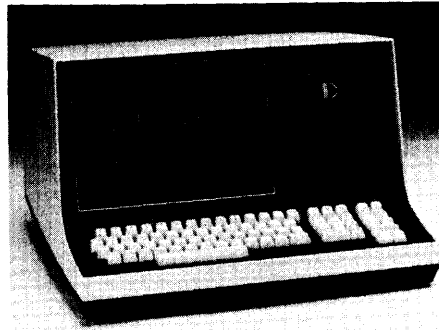

Datapoint 8200 Workstation

**Workstation
8200**

July 1981 Document No. 60786

Copyright © 1981 by Datapoint Corporation.
Printed in U.S.A. All rights reserved.

The "D" logo, Datapoint and DATASHARE are trademarks of Datapoint Corporation, registered in the U.S. Patent and Trademark Office. RMS and Resource Management System are trademarks of Datapoint Corporation.

Table of Contents

1.0 General Description 1
 2.0 System Requirements 1
 3.0 Technical Description 1
 3.1 Technical Specifications 2
 3.2 Operator Controls 2
 3.3 Keyboard 2
 3.4 Control Codes and Display Characters 3
 3.5 Escape and Subscreen Operation 4
 3.6 Off-Line Operation 7
 3.7 Down-Line Loaded Character Sets 13
 4.0 Physical Description 15
 5.0 Environmental Requirements 16
 6.0 Interface Requirements 16
 7.0 Options 16
 8.0 Shipping List 16

operator to display unshifted characters when in the SHIFT LOCK mode.

- **Cursor, Line Spacing, and Bell Options**

These options permit the operator to select alternative controls and commands over cursor movement, line spacing, and the 'bell' function.

Two advanced modes of operation are available in the Configuration Option Mode: Escape and Subscreen Mode. The Escape and Subscreen modes can enable more flexible operator action on the 8200 Workstation. Refer to Section 3.5 for a detailed description of the Escape and Subscreen modes.

The standard 8200 Workstation is provided with a fixed keyboard and a high-contrast green display. The Model 8211 Workstation is available with a detached keyboard and a green display.

2.0 System Requirements

The 8200 Workstation uses standard EIA RS-232-C (also CCITT V.24) voltage levels. Serial asynchronous protocol and control is used to communicate to the host processor using direct or modem connection. When the workstation is transmitting, two stop bits are generated. When the workstation is receiving, only one stop bit is required.

2.1 Direct Connection

The data drivers in the 8200 are capable of driving 250 feet at 9600 baud, 500 feet at 4800 baud, and 1000 feet at 2400 baud or less. The cables used in these applications are standard Datapoint cables. Ask your Datapoint Customer Service Representative for the exact cables needed. The data drivers in the remote device may restrict the cable length to less than these limits. Requirements for cable lengths which exceed these limits must be submitted to Datapoint Customer Service Technical Support for review and approval.

2.2 Modem Connection

The 8200 Workstation can communicate through any EIA RS-232-C or CCITT V.24 compatible full duplex, asynchronous modem at the specified baud rates. Maximum cable length between the terminal and a modem is 50 feet using shielded twisted pairs. (Permissible cable length between modems varies with the vendor and product selected by the user.)

2.3 Local Printer

A connection on the I/O connector provides for the attachment of a printer with a serial RS-232-C (CCITT V.24) ASCII interface. Data received from the host processor is routed to the printer in addition to being displayed on the screen. Receipt of the special control characters, Printer On and Printer Off, control gating of the data to the printer. The printer must operate at the same baud rate as the workstation to which it is attached.

Workstation 8200

Continued....

2.4 Communication Options

The 8200 Workstation has two types of communications options: parity and baud rate selections.

The parity options include:

- 1) Select even parity and 7 bit word.
- 2) Select odd parity and 7 bit word.
- 3) Select "1" parity and 7 bit word.
- 4) Select "0" parity and 7 bit word.

The baud rate selection options include:

50	200	600	4800
75	220	1200	9600
110	300	1800	
150	440	2400	

3.0 Technical Description

3.1 Technical Specifications

DISPLAY SIZE
5" x 8" (approx.)
12" diagonal

CHARACTERS PER LINE
80

NUMBER OF LINES
24

CHARACTER SIZE
Greater than 0.071" x 0.146"

CHARACTER GENERATION METHOD
5 x 7 dot matrix

DEFLECTION TYPE
Magnetic

CHARACTER GENERATOR
RAM

TYPE OF SCREEN REFRESH MEMORY
RAM frame memory

DISPLAY REFRESH RATE
60/50 times per second
(determined by line frequency)

CHARACTER SET
ROM, PROM, or Down-Line Loaded

CURSOR
Non-destructive, blinking

3.2 Operator Controls

3.2.1 ON/OFF Switch

The ON/OFF switch is located on the right side of the 8200 base plate. A red light to the right of the keyboard indicates when power is on.

3.2.2 Display Brightness

The operator can temporarily adjust the brightness level of the screen by taking the following actions:

To cause brightness to increase, hold down the CTRL key and press the key above the CTRL key.

To cause brightness to decrease, hold down the CTRL key and press the key below the CTRL key.

Note: Long term operation at maximum brightness is not recommended.

3.2.3 Repeat Action Keys

If the local display option is enabled, the repeat action feature causes a character to be displayed on the screen at the rate of 15 per second after its key has been held down for one-half second. If the local display option is disabled, the host processor must echo back the repeated codes.

3.3 Keyboard

Data transmitted from the 8200 Workstation originates from the keyboard except for configuration/interrogation data from a down-line load. The 8200 is provided with a Universal keyboard. The keyboard has ten function keys, an eleven-key numeric pad, and 55 alphanumeric keys. The keyboard is shown in Figure 3-1. The octal character codes sent by these keys are shown in Figure 3-2.

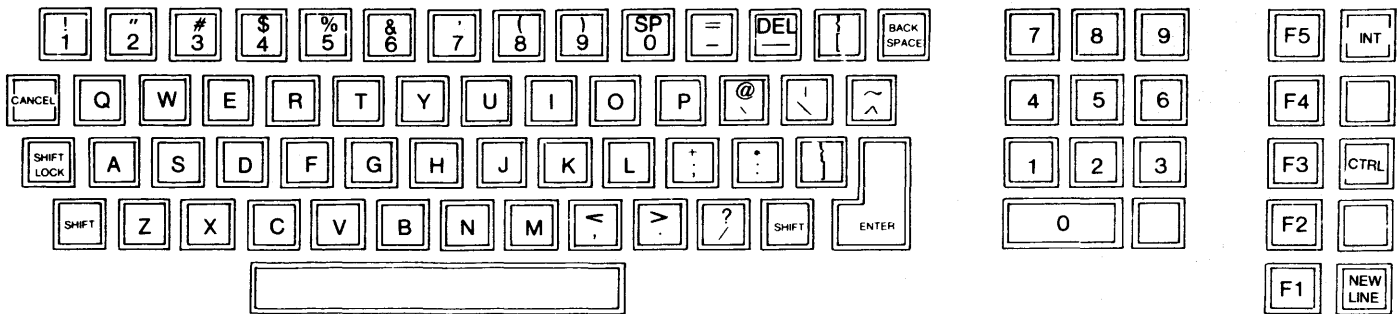

Figure 3-1: Universal Keyboard

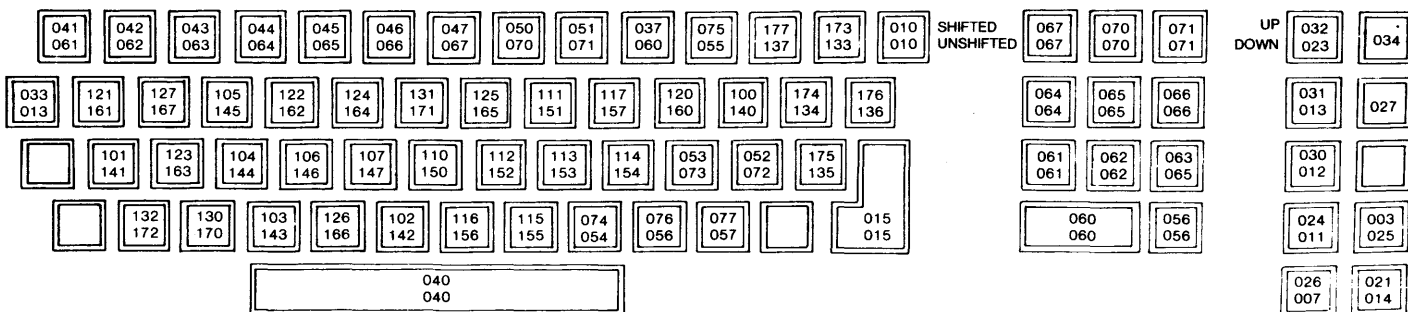
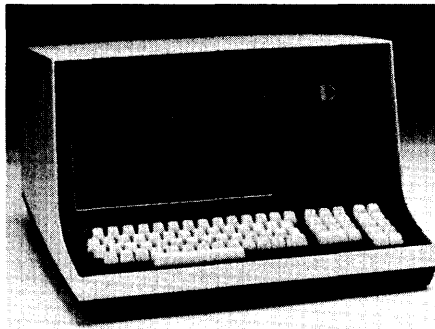

Figure 3-2: Octal Character Code Transmission

* 025 and 027 are optional codes enabled by 'TX HOME' and 'TX ERASE'

Workstation 8200



3.3.1 Roll

The keyboard has an n-key rollover capability. The n-key rollover capability allows keys to be depressed sequentially or simultaneously. A valid code is generated for each depression, whether or not previously depressed keys are released. Codes are generated in the order that the keys are depressed.

3.3.2 Repeat

The 8200 keyboard provides an automatic repeat function. All alphanumeric keys and the backspace key generate a repeating code. Control and function keys (Shift, Shift Lock, Enter, Cancel) do not generate repeating codes. The automatic repeat function is inhibited whenever two or more keys are depressed. There is a delay of 1/2 second from the time a key is depressed until the repeating function begins. Thereafter, the keycode is repeated at a rate of 15 codes per second until the key is released. Note that when a key has been held down long enough to begin generating repeated codes, depressing another key not only cancels generation of repeating codes on the first key, but also suppresses generation of repeated codes on the second keycode. After such a key rollover, all keys must be released before any further repeated keycodes can be generated.

3.3.3 Keycodes

The keyboard generates a unique keycode for each key. Function keys generate different "Key Up" and "Key Down" codes. Shifted and Unshifted keys generate different keycodes, except for the Backspace and Cancel keys, the space bar, and the decimal point. The "Key Down" code on function keys is changed when shifted, but the "Key Up" code is not changed. The control logic translates these codes to system keycodes which are stored in RAM. The codes shown in Figure 3-2 are the standard 8200 Workstation keycodes.

3.3.4 Keyboard Function Keys

The function keys, except for the CTRL key, can be programmed by the user via a down-line load to transmit characters. A list of keys and their default functions, and any special options they permit, is below.

F5 - Can be an extension of the INT key if the DBL KEY option is selected. (See Configuration Option Mode 3.6.1)

F4 - Can be programmed by the user.

F3 - (LINE FEED) Causes each line displayed to move up one line when the cursor is on the 24th line. This key transmits an octal 012 to the host processor. (See Configuration Option Mode 3.6.1)

F2 - Causes a break condition if the BREAK option is selected. (See Configuration Option Mode 3.6.1)

F1 - Can be an extension of the NEW LINE key, if the DBL KEY option is selected. (See Configuration Option Mode 3.6.1)

INT (Interrupt) - Causes transmission of an octal 034.

ERASE - (key between the INT and CTRL keys) Causes the screen to be erased from the current cursor position to the end of the screen if the LOC ERASE option has been selected. This key causes an EEOF system keycode to be transmitted if the TX ERASE option is selected. (See Configuration Option Mode 3.6.1)

CTRL (Control) - Causes the transmitted code to be logically "anded" with a 037, giving the equivalent of a control character. This control function is not latched, so this key must be held down whenever used and when repeating a control code. (See Configuration Option Mode 3.6.1)

HOME - (blank key between the CTRL and NEW LINE keys) Causes the cursor to be positioned in the 'Home' position (leftmost position in the top line), if the LOC HOME option is selected. If the TX HOME option is selected, a 'Home Up' system keycode will be transmitted. (See Configuration Option Mode 3.6.1)

NEW LINE - Causes an octal 014 to be transmitted to the Datapoint processor. No local action occurs. Bit 8 of each character transmitted is the parity bit. Transmitted parity is even (the number of '1' or mark bits in each character, including bit 8, is even). Transmitted parity may be changed during the Configuration Option Mode to transmit odd parity, even parity, 1 mark or 0 mark.

3.4 Control Codes and Display Characters

The control codes, display characters, and their respective functions are listed below with the exception of ESC (033) and DLL REQ (034). Unused codes will have no effect on the terminal if the PRINT ALL option is disabled. If the PRINT ALL option is enabled, the unused codes below 040 will print their octal values on the screen. These unused character codes can be down-line loaded to obtain additional printable characters (as in the KataKana character set).

All characters above 040, except 0177, will print their respective ASCII character on the screen. Refer to the code chart (Fig 3-1) for the octal character codes. The 0177 character can either be a displayable character or a PAD character depending on the setting of the PRINT DEL option. If the PRINT DEL option is not set, 0177 becomes a PAD character. The PAD character is completely ignored by the terminal. It is useful for implementing time delays so that the terminal or printer can finish a function that it has been commanded to perform.

Bell 007 Causes a 1200 Hz tone to be generated.

Backspace 010 Causes the cursor to move one character to the left, unless the cursor is already at the first character position on a line (leftmost character position of the subscreen if the Subscreen option is enabled - see Section 3.5). If the cursor is in the first character position of a line, no action will be taken.

Tab 011, x, y Causes the cursor to be positioned at the screen location addressed by the two octal coordinates following the TAB control character. The first coordinate is the horizontal location (000-117); the second coordinate is the vertical location (000-027).

If the cursor is positioned off the screen, displaying will be inhibited until a command is received that positions the cursor back on the screen. If the Subscreen option is in effect, the x and y coordinates are relative to the top left corner of the subscreen. The cursor is considered off the screen if it does not reside within the subscreen (See Section 3.5). The tab will be aborted if more than 2 seconds elapses between receipt of the x and y coordinates.

Workstation 8200

Continued....

Line Feed (LF) 012 Causes the cursor to move down one line unless the cursor is currently on the bottom line of the screen, or the last line of the subscreen if the Subscreen option is enabled. If the Auto Roll option is enabled, the Subscreen option is disabled, and the cursor is on the 24th line receipt of this character causes the displayed data to move up one line. If the Auto Roll and Subscreen options are both enabled, receipt of this character causes the displayed data on the subscreen's bottom line to move up one line.

Roll Up (RU) 013 Causes data to move up one line and erases the bottom line. If the Escape options are enabled, the Roll Up will occur only on those lines defined by the Set Roll Window command. If the inverted video is active at the time of the Roll Up, the bottom line erased is filled with highlighted spaces. If the Subscreen option is in effect (Section 3.5), the Roll Up affects only those characters residing within the subscreen.

Roll Down (RD) 003 Causes the data displayed on the screen to move down one line leaving the top line blank. The Roll Down command will not affect the cursor position. If the Escape options are in effect, the Roll Down occurs only on those lines defined by the Set Roll Window command. If the inverted video or two-level video is being used at the time of the Roll Down, the top line erased will be filled with highlighted spaces. If the Subscreen option is in effect, the only characters affected by the Roll Down are those residing in the subscreen. (See Section 3.5 for information concerning the Subscreen option.)

Carriage Return (CR) 015 Causes the cursor to return to the first character position of the current line. If the Subscreen option is in effect, the cursor returns to the left window position of the current line.

Cursor On (CUR ON) 030 Turns on the blinking cursor if it was previously turned off. If the cursor is already on, this command will have no effect.

Cursor Off (CUR OFF) 031 Turns off the cursor if the CURSOR OFF option is enabled. The cursor will remain off until another Cursor On character is received. Characters received from the Datapoint processor may be displayed and transmitted from the keyboard while the cursor is off. If the CURSOR OFF option is disabled, this command will have no effect.

Erase to End-of-Line (EOL) 026 Causes the current line to be erased from and including the current cursor position to the end of the line. The cursor position will not change. If inverse or two-level video is in use upon receipt of this command, the line is filled with highlighted spaces. If the Subscreen option is enabled, the end of the line will be the right edge of the subscreen. If the cursor is off the screen, or subscreen, no action will be taken by the 8200 Workstation.

Printer On (PRT ON) 032 Causes data received by the workstation to be sent to an attached serial printer as it is being displayed. The 8200 requires 2 milliseconds of 'dead time' on the serial line after receipt of the Printer On character. The 'dead time' is defined as the time between the stop bit of the Printer On character and the start bit of the next character.

Printer Off (PRT OFF) 024 Inhibits printing of received data on an attached serial printer. Printing will be inhibited until a Printer On character is received. The 8200 requires 2 milliseconds of 'dead time' on the serial line after receipt of the Printer Off character.

3.5 Escape and Subscreen Operation

The 8200 Workstation has two advanced modes of operation: Escape Mode and Subscreen Mode. These modes can be specified in the Configuration Option Mode (see Section 3.6.1).

If the Escape option (ESC OPTS) is enabled and the Subscreen Option is disabled, the 8200 Workstation will be in Escape Mode. Figure 3-3 describes the screen variables used in the Escape Mode.

Variable	Description	Range
W1	Top line of screen for vertical rolls (roll up, roll down)	0 - 027
W2	Bottom line screen for vertical rolls (roll up, roll down)	0 - 027
W3	Top line of screen for horizontal scrolls (left side scroll, right side scroll)	0 - 027
W4	Bottom line of screen for horizontal scrolls (left side scroll, right side scroll)	0 - 027

Figure 3-3: Escape Mode Variables

In the Escape mode, a Reset Window command is automatically executed during power up, after receipt of a new configuration, and after a configuration restore command. The Reset Window Command then sets W1 = 0, W2 = 027, W3 = 0, and W4 = 027.

If the Subscreen option is enabled, the Escape functions are automatically enabled (regardless of the value of ESC OPTS - see Section 3.6.1). In Subscreen mode, control characters affect only the subscreen, with the exception of standard video, inverse video, and two-level video which affect the entire screen. The variables used in the Subscreen Mode are described in Figure 3-4.

Variable	Description	Range
W1	Top line of subscreen	0 - 27
W2	Bottom line of subscreen	0 - 27
W3	Left edge of subscreen	0 - 0117
W4	Right edge of subscreen	0 - 0117

Figure 3-4: Subscreen Mode Variables

All control codes are executed relative to the subscreen. For example, a Home Up command positions the cursor to the left corner of the subscreen. In a tab x, y sequence, the x and y must be relative to the top left corner of the subscreen. The cursor is considered off the screen whenever it does not reside within the subscreen. The vertical rolls and horizontal scrolls are controlled by the same top and bottom lines of the subscreen. Characters outside the subscreen are unaffected by any

control code executed within the subscreen. In the subscreen mode, a Reset All Windows command sets the variables W1, W2, W3, and W4 back to the full screen values. See Figure 3-5 for an example of subscreen operation.

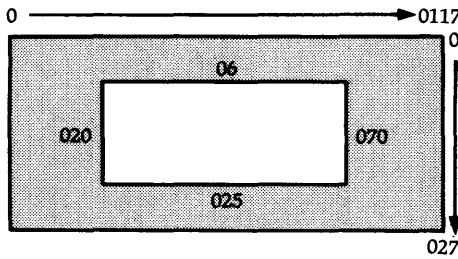

Figure 3-5: Subscreen Operation

Where:

- W1 = 06 (top of subscreen)
- W2 = 025 (bottom of subscreen)
- W3 = 020 (left side of subscreen)
- W4 = 070 (right side of subscreen)

Shaded area indicates the part of the workstation screen not affected by subscreen operation. Screen coordinates are in octal notation.

3.5.1 Escape Sequences

The following commands are invoked by sending an Escape character (033) before the command. This enables a number of additional commands to be implemented in the terminal. All Escape commands may be disabled in the Configuration Mode by specifying 'NO' to the SUB SCRN and ESC OPT questions, or by down-line loading a new configuration that disables both the Escape and the Subscreen options. See Figure 3-6 for an example of a Roll operation in the Escape Mode. See Figure 3-6 for an example of a Scroll operation in the Escape Mode.

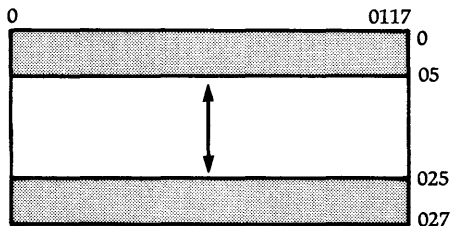
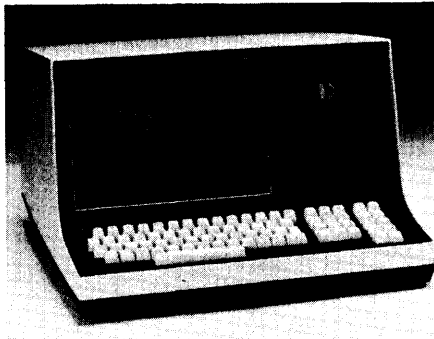

Figure 3-6: Roll Operation in Escape Mode

Where W1 = 05 (top of subscreen)
and W2 = 025 (bottom of subscreen)

Shaded area indicates the part of the workstation not affected by the roll operation. Screen coordinates are in octal notation.



Workstation 8200

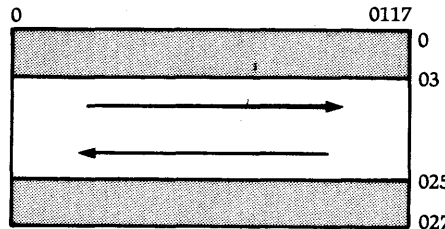

Figure 3-7: Scroll Operation in Escape Mode

Where W3 = 03 (top of subscreen)
and W4 = 025 (bottom of subscreen)

Shaded area indicates the part of the workstation screen not affected by a scroll operation. Screen coordinates are in octal notation.

Set Roll Window (ROLL WNDO)
033, 017, W1, W2

When the Subscreen option is disabled and a Set Roll Window is performed, W1 defines the top line and W2 defines the bottom line of the screen to be affected in the vertical roll operation. W1 and W2 must be in the range of $0 \leq W1 \leq W2 \leq 027$. If the preceding equation is not met, W3 is set to 0 and W4 is set to 027. If the Subscreen option is enabled, W1 defines the top line of the subscreen and W2 defines the bottom line of the subscreen.

W1 and W2 must each be received within five seconds from the time that 033, 017 is processed. If W1 and W2 are not received in the specified time period, this sequence will be aborted.

Set Scroll Window (SCRL WNDO)
033, 020, W3, W4

When the Subscreen option is disabled and a Set Scroll Window operation is performed, W3 defines the top line and W4 defines the bottom line of the screen to be affected. W3 and W4 must be in the range of $000 \leq W3 \leq W4 \leq 027$. If the preceding equation is not met, W3 is set to 0 and W4 is set to 027. If the Subscreen option is enabled, this command defines the left (W3) and right (W4) boundaries of the subscreen. In this case, W3 and W4 must be in the range $000 \leq W3 \leq W4 \leq 0117$.

If W3 and W4 are not received within 5 seconds from the time the 033, 020 is processed, this sequence is aborted. However, if the timeout occurs while processing W3 and W4, W1 and W2 will remain updated.

Set All Windows (ALL WNDO)
033, 016, W1, W2, W3, W4

When the Subscreen option is disabled, the Set All Windows command defines both the Vertical Roll Window (W1 and W2) and the Horizontal Scroll Window (W3 and W4). If the Subscreen option is enabled, this command defines the Subscreen, i.e., W1=TOP, W2=BOTTOM, W3=LEFT, and W4=RIGHT coordinates of the subscreen. This command executes in pairs. W1 and W2 are processed first, followed by W3 and W4.

NOTE: If W1 and W2 or W3 and W4 are not received within 5 seconds from the time that 033, 016 is processed, this sequence is aborted. However, if the timeout occurs while processing W3 and W4, W1 and W2 will remain updated.

Reset All Windows (RSTWNDO)
033, 014

If the Subscreen option is not in effect, the Reset All Windows command sets the Vertical Roll and Horizontal Scroll Windows both to TOP (W1, W3) = 000 and BOTTOM (W2, W4) = 027. If the Subscreen option is in effect, this command defines the subscreen as the full screen, i.e., TOP (W1) = 0, BOTTOM (W2) = 027, LEFT (W3) = 0, RIGHT (W4) = 0117. A Reset All Windows command is automatically executed by the 8200 Workstation during power up, after exiting the off-line mode, and after receiving a configuration load or restore sequence.

Horizontal Scroll Left (LSCROLL)
033, 001, CHARtop, CHARtop=
1, ..., CHARbot-1, CHARbot

The Horizontal Scroll Left command causes each column of the screen to shift left by one character position beginning with the line defined as TOP (W1 for Subscreen option, W3 for Escape option) through and including the line defined as BOTTOM (W2 for Subscreen option, W4 for Escape option). The characters in column 0 (LEFT edge, W3, if Subscreen option is enabled) will be lost. The character positions in column 0117 (RIGHT edge, W4, of

Workstation 8200

Continued....

subscreen if Subscreen option is enabled) that were filled with blanks as a result of the shift will be replaced by the characters (CHARtop, ..., CHARbot) supplied. No escape sequences may be imbedded within the characters supplied except for the following:

1. Set Standard Video Mode (033, 004)
2. Set Inverse Video Mode (033, 005)
3. Set Two-Level Video Mode (033, 006)
4. Force Display of Next Character (033, 033, Char)

Horizontal Scroll Right (RSCROLL)
033, 002, CHARtop, CHARtop+1, ..., CHARbot-1, CHARbot

The Horizontal Scroll Right command causes the screen beginning with the line defined as TOP to shift right by one character position (W1 for Subscreen option, W3 for Escape option) through and including the line defined as BOTTOM (W2 for Subscreen option, W4 for Escape option). The characters in column 0117 (RIGHT edge, W4, of the subscreen if the Subscreen option is enabled) will be lost. The character positions in column 0 (Left edge, W3, of subscreen if the Subscreen option is enabled) that were filled with blanks as a result of the shift will be replaced by the characters (CHARtop, ..., CHARbot) supplied. No escape sequences, other than the following, may be embedded with the characters supplied:

1. Set Standard Video Mode (033, 004)
2. Set Inverse Video Mode (033, 005)
3. Set Two-Level Video Mode (033, 006)
4. Force Display of Next Character (033, 033, Char)

Insert Character Into Field (FLD INS)
033, 021, x, y

The Insert Character Into Field command causes all characters within a specified field to be shifted to the right by one character position. The field starting point is defined by the current cursor position, and the field end point is defined by the x and y coordinates supplied with the command. The Insert command shifts the character behind the cursor to the right one location, along with all characters up to the end of the field.

Line wrap-around is in effect when the field spans more than one line. The last character of a line appears as the first character of the next line. Screen wrap-around will also be in effect when the field end point is above the cursor. The last character of the bottom line will appear as the first character of the top line.

The character at the x, y location is lost. A space character (040) is placed under the cursor. The inserted space character will have the same highlighting as the character that was previously under the cursor.

This command cannot be executed if the field end point defined by the x and y coordinates points to a location that is off the screen, or if the cursor is off the screen. If the Subscreen option is disabled, the following equations must be satisfied:

$$0 \leq x \leq 0117$$
$$0 \leq y \leq 027$$

If the Subscreen option is enabled, x and y are relative to the top left corner of the Subscreen, hence:

$$0 \leq x \leq W4 - W3$$
$$0 \leq y \leq W2 - W1$$

W1, W2, W3, W4 are the four windows that define the subscreen. Characters outside the subscreen are unaffected.

Delete Character From Field (FLD DEL)
033, 022, x, y

The Delete Character From Field command shifts all characters within a specified field to the left by one character position. The field starting point is defined by the current cursor position, and the field end point is defined by the x and y coordinates supplied with the command. The character under the cursor is lost, and the character to the right of the cursor is moved under the cursor. All characters up to and including the end of the field are shifted, and a space is inserted at the x, y location.

Line wrap-around and screen wrap-around are in effect. The inserted space character has the same highlighting as the character that was previously at the x, y location. This command cannot be executed if the field end point defined by the x and y coordinates points to a location that is off the screen (or subscreen), or if the cursor is off the screen. If the Subscreen option is disabled, the following equations must be satisfied:

$$0 \leq x \leq 0117$$
$$0 \leq y \leq 027$$

If the Subscreen option is enabled, x and y are relative to TOP, LEFT corner of the subscreen, hence:

$$0 \leq x \leq W4 - W3$$
$$0 \leq y \leq W2 - W1$$

W1, W2, W3, and W4 define the subscreen.

Set Standard Video Mode (STND VD)
033, 004

The Set Standard Video Mode command displays all succeeding characters in standard video until a highlighting command is received. During power up and after a Configuration Load or Restore Command sequence, the 8200 Workstation automatically enters standard video mode.

Set Inverse Video Highlighting Mode (INV VD)
033, 005

The Set Inverse Video Highlighting Mode command causes all succeeding characters to be displayed in inverse video until another highlighting command is received. If any characters previously on the screen were placed there in highlighted mode, they will be changed to inverse video highlighting (even if they were placed on the screen in two-level video highlighting mode). Erase, Roll Up, and Roll Down commands executed while inverse video is active place spaces on the screen in inverted video mode. Characters placed on the screen due to a horizontal scroll command are displayed in inverse video.

Set Two-Level Video Highlighting Mode (2LEV VD)
033, 006

The Set Two-Level Video Highlighting Mode command displays all succeeding characters in two-level video (brighter than standard video) until another highlighting command is received. If any characters previously on the screen were put there in highlighted mode, they are changed to two-level video highlighting (even if they were placed on the screen in inverse video highlighting mode).

Set Character Under Cursor to Standard Video (INV CUR)
033, 037

The Set Character Under Cursor To Standard Video command converts the character under the cursor to standard video. This command does not change the highlighting mode of the 8200 Workstation.

Set Character Under Cursor to Inverse Video (INV CUR)
033, 036

The Set Character Under Cursor To Inverse Video command displays the character under the cursor in inverse video mode. This command changes the highlighting mode to inverse video only if the 8200 is in the two-level video mode when this command is received.

Set Character Under Cursor to Two-Level Video (2LEV CUR)
033, 037

The Set Character Under Cursor To Two-Level Video command displays the character under the cursor in two-level video (brighter than standard video). This command changes the highlighting mode to two-level video only if the 8200 is in the inverse video mode when this command is received.

Insert Line (INS LIN)
033, 024

The Insert Line command causes a Roll Down to be performed between the line containing the cursor and the last line of the screen (bottom edge, W2, of subscreen if the Subscreen option is enabled). The bottom line is lost; all lines between the line containing the cursor and the bottom line are shifted down by one line; and the line containing the cursor is erased. If the cursor is off the screen (outside the subscreen) or if the cursor is not within the roll window, this command is ignored.

Workstation 8200

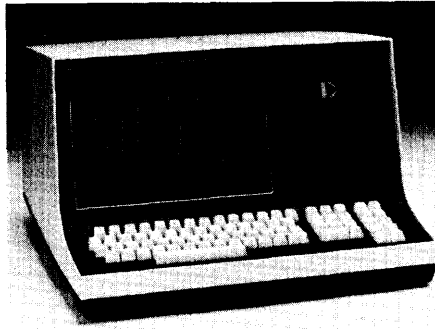

Delete Line (DEL LIN) 033, 032

The Delete Line command causes a Roll Up to be performed between the line containing the cursor and the last line of the screen (bottom edge of subscreen if the Subscreen option is enabled). The line containing the cursor is lost, and the bottom line is erased. If the cursor is off the screen (outside the subscreen) or not within the roll window, this command will be ignored.

Duplicate Character (DUP CHAR) 033, 023, CHARACTER, COUNT

The Duplicate Character command displays (COUNT) number of characters (CHARACTER) where $0 \leq \text{CHARACTER} \leq 0117$ and $0 \leq \text{COUNT} \leq 0117$. This sequence may not be active whenever another escape sequence is active, such as a left or right scroll. If the character is less than 040 and is usually a control character, the character is displayed, and the function is not executed.

Open Line (OPENLN) 033, 010

The Open Line command causes 80 character spaces to be inserted on the screen beginning with the cursor and continuing to a point one line below the cursor. When the screen rolls down to accommodate the extra 80 character spaces, the bottom line of the screen will be lost. The characters from and including the cursor character are copied to the line directly below the cursor.

If the cursor is on the bottom line of the screen when this command is received, an erase to end of line is performed. If the Subscreen option is enabled, the number of spaces inserted on the screen is relative to the width of the current subscreen line. If the cursor is off the screen or subscreen, the command will have no effect. If the Escape option is in effect, the scope is the roll window.

Close Line (CLOSELN) 033, 011

The Close Line command has the opposite effect of the open line command. It removes one line (80 character positions) of characters from the screen starting with the current cursor location and continuing to the next line directly below the cursor position. The bottom line of the screen becomes blank, and all lines between the bottom line of the screen and the line below the cursor will appear to roll up one line. If the Close Line command is performed while the cursor is on the bottom line of the screen, then the effect will be that of an erase to end of line command.

If the cursor is positioned off the screen when this command is received, then no action is taken. If the Subscreen option is enabled, the character spaces removed are relative to the current subscreen line width. If the Escape option is in effect, the scope is limited to the roll window.

Force Display of Next Character (F DISP) 033, 033, CHAR

The Force Display of Next Character command causes CHAR to be treated as a display character independent of ASCII value. If the cursor is off the screen or subscreen, the character will not be displayed.

3.6 Off-Line Operation

The 8200 has two submodes of operation which are accessible through the Off-Line Mode: Configuration Option Mode and Diagnostic Mode. Off-Line operation can be selected through the 8200 keyboard.

To cause the 8200 to operate off-line, the following keyboard actions must be taken:

- Hold down the CTRL key,
- Depress the INT key twice in succession,
- Release the CTRL key.

Any data displayed on the screen prior to going off-line will be erased, and the display shown will appear as in Figure 3-8.

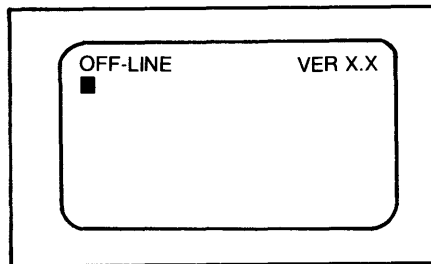

Figure 3-8:
Workstation Screen in the Off-Line Mode

To return to on-line operation, the Off-Line Access Sequence must be repeated. The display will be erased and the cursor will appear in the first character position of the first line (Home Up position). The 8200 will also return to on-line operation after it is powered OFF and then powered ON again.

3.6.1 Configuration Option Mode

The Configuration Option Mode is designed to permit the user to tailor the response of the 8200 so it can take advantage of the capabilities of the host processor. The Configuration Options provide five general areas of terminal features: Operator Convenience Options, Communication Options, Character Options, Cursor, Line Spacing and Bell Options, and Local Control Options. (See Sections 3.6.1.1 through 3.6.1.5.)

When the workstation is in the off-line mode, the Configuration Option Mode may be selected by keying in '(OPT)'. Previously displayed data will be erased. An illegal key entered before or during the access sequence causes a beep, but leaves the workstation in the off-line mode.

NOTE: The SHIFT key must be held down when entering the parentheses (), but not when entering OPT.

After the workstation enters the configuration mode, the CRT display shown in Figure 3-9 appears. A message describing each option is displayed along with the current setting of the option. Baud rate information is displayed in its numeric value. If the receive baud rate is set at 9600 baud, the display will show "RX BAUD 9600". Parity option information is displayed with the word "PARITY" followed by a 1 for one parity, a 0 for zero parity, an E for even parity, or an O for odd parity. The remaining options are displayed with a brief message followed by a "Y" or an "N" to indicate whether or not a particular option is enabled.

To set each option, enter the setting desired in the same manner it is displayed. (To set baud rates, enter the numeric value desired.) To skip an option where no change is required, press ENTER. When all the options have been selected, an "ADJUST BRIGHTNESS" message is displayed, followed by a "DONE?". To adjust brightness, hold the CTRL key down. Press the key above it to increase brightness one level. Press the key below it to decrease brightness one level. Release the CTRL key when the appropriate brightness level is reached.

Workstation 8200

Continued....

After adjusting the display brightness, enter a Y in response to the "DONE" message if no further changes are needed on the configuration option display. If a Y is entered, the display screen will go blank and the new option settings will be written to the nonvolatile memory. If any other response is entered, the cursor is repositioned to the first option. Each option may then be corrected or changed as necessary.

OFF-LINE		VER X.X
RX BAUD	9600	
TX BAUD	1200	WP RPT N
PARITY	E	
DBL KEY	Y	
UP CASE	N	
BREAK	N	
LOC ERASE	N	
TX ERASE	N	
LOC HOME	N	
TX HOME	N	
LOC DISP	N	
CTRL KEY	N	
AUTO ROLL	N	
AUTO CR/LF	N	
ROLL DN	N	
PRINT ALL	N	
PRINT DEL	N	
CURS OFF	Y	
BELL	N	
ESC OPTS	N	
SUB SCRIN	N	
ALPHA OPT	N	ADJUST BRIGHTNESS
GP KBD	N	DONE?

Figure 3-9: 8200 Sample Display Screen During Configuration Option Mode

3.6.1.1 Operator Convenience Options

These options allow the operator to change the display brightness or make the keyboard similar to a Datapoint 3600 keyboard.

Brightness Control

While in the configuration mode, brightness can be permanently adjusted. To increase the brightness one level, hold the control key (CTRL) down, and press the key above it once. Each momentary depression of the key above the CTRL key increases brightness one level. To decrease brightness one level, hold the control key (CTRL) down, and press the key below it once. Each momentary depression of the key below the CTRL key decreases brightness one level.

When the 8200 is powered off and powered on again, the brightness level will default to that specified during the Configuration Option Mode.

Double Key (DBL key)

When using the Universal Keyboard, the Double Key option may be used to prevent keying errors if experienced 3601 operators are using the 8200 Workstation. This option causes the F5 key to act as an extension of the INT key, and the F1 key to act as an extension of the NEW LINE key.

When this option is disabled, the F5 key and the F1 key return to the respective codes assigned to them. The Double Key option can be enabled or disabled by a down-line load. This option is not available if the general purpose keyboard option is set.

3.6.1.2 Communications Options

The communications options allow the operator to select baud rates, parity format and modifications to character codes transmitted.

Baud Rates (RX BAUD and TX BAUD)

The baud rates option permits selection of the transmit and receive baud rates (independently) for the communications channel. These baud rates are listed below.

50	75	110	150
200	220	300	440
600	1200	1800	2400
4800	9600		

When the terminal is in the configuration mode, and the cursor is flashing next to the "RX BAUD" or "TX BAUD" messages, the baud rate may be changed by entering the desired baud rate from the list above. If no change to the baud rate is necessary, press the ENTER key to advance the cursor to the next option. Baud rate options cannot be changed by a down-line load.

Parity Options (PARITY)

The parity option permits selection of the type of parity bit to be appended to the seven bits of data transmitted to the host processor. When the 8200 is in the configuration mode and the cursor is flashing next to the "PARITY" message, the parity options may be entered. The workstation ignores the parity bit on incoming data.

Even Parity: "E"

Enter the character "E" for even parity. An even parity bit will be appended to the seven data bits.

Odd Parity: "O"

Enter the character "O" for odd parity. An odd parity bit will be appended to the seven data bits.

1 Parity: "1"

Enter the character "1" for 1 Parity. A "1" bit will be appended to the seven data bits.

0 Parity: "0"

Enter the character "0" for 0 Parity. A "0" bit will be appended to the seven bits transmitted to the host processor.

Control Key (Control Code Generation - CTRL KEY)

The Control Key option enables the operator to generate all the ASCII control characters for system keycode transmission to the host processor.

When a Y is entered in response to the "CTRL KEY" message, the workstation alters the system keycode of the CTRL key. Any alphanumeric key depressed when the CTRL key is held down, excluding the other control keys, will be transmitted to the host processor and the keycode will be logically "anded" with a 037. Other functions of the CTRL key do not change.

3.6.1.3 Character Options

The character options allow the operator to either display additional characters or display only upper case characters.

Workstation 8200

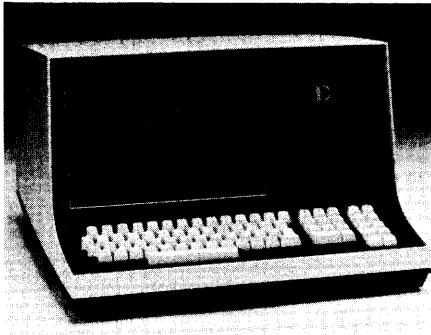

Upper Case Character Set Only (UP CASE)

If the Upper Case Only option is selected by entering a Y to the "UP CASE" message, the workstation will substitute upper case system keycodes for lower case codes before transmitting them to the host processor. The 26 alphabetic keycodes are the only codes which are modified. Display data received from the host processor is not affected.

Print Additional Characters (PRINT ALL)

The Print Additional Characters option allows the operator to increase the number of displayable characters. By entering a Y to the "PRINT ALL" option, the workstation will display ASCII characters below octal 040.

If this option is disabled, the workstation will ignore all ASCII characters received from the host processor below 040 except the control characters.

General Purpose Keyboard Option (GP KBD)

The General Purpose Keyboard option is reserved for future use.

SHIFT and ALPHA Configuration

The right shift key has two configuration options: SHIFT and ALPHA. If a Y is entered in response to the "ALPHA OPT" message, the right shift key will be changed to the Alpha configuration. If an N is entered, the right shift key will be in shift configuration.

The 8200 keyboard can operate in two modes of shift operation: SHIFTED and UNSHIFTED. The SHIFT key provides a momentary shift mode while it is held down. The SHIFT LOCK key, when pressed, places the keyboard in shift mode. The keyboard will remain in the shift mode until the SHIFT key is pressed again. An indicator light in the shift key signals the operator when the keyboard is in shift lock mode. The keyboard is initialized to the unshifted mode when the workstation is powered on.

The SHIFT and SHIFT LOCK keys do not generate a keycode, but do cause the codes generated by the other keys to be altered. The space bar and decimal point on the numeric pad are unaffected by the shift/unshift mode. The control keys generate separate codes for shifted and unshifted keys on depression, but the codes sent on release are unaffected by the shift function.

The right SHIFT key can operate as a shift key as described above or as an ALPHA key. The SHIFT key can be temporarily set to the Alpha key option by specifying the ALPHA KEY option while in the configuration mode. The ALPHA key when held down momentarily returns the keyboard to the unshifted mode when in the shift lock mode. The keyboard returns to the shift lock mode when the ALPHA key is released. The shift lock indicator light remains lit when the alpha key is depressed or released.

The left hand shift key will always operate as a standard SHIFT key, regardless of the configuration of the right shift key.

Word Processing Repeat Option (WP RPT)

The Word Processing Repeat option is reserved for future use, and is not available on the current 8200 Workstation.

3.6.1.4 Cursor, Line Spacing, and Bell Options

These options allow the user to select alternative controls over cursor movement, line spacing and the bell function.

Line Feed and Carriage Return After Printing Rightmost Character of Line (AUTO CR/LF)

Each time a character is received by the terminal and displayed on the screen, the cursor is moved to the next character position on the screen. The AUTO CR/LF option controls the character display after the rightmost character is received.

If the AUTO CR/LF option is not enabled and the rightmost character of a line has already been received, the last character of any additional characters received is displayed in the last character position. Characters previously in that position will be lost. All other characters in the line are not disturbed.

If the AUTO CR/LF option is enabled and the rightmost character of a line has already been received, the cursor will move to the next line and display any additional characters received. Upon displaying a character in the rightmost position of the 24th line (or the bottom line of the subscreen if the Subscreen option is enabled), the cursor moves to the first position of the current line. Additional characters received overwrite the line. However, if the AUTO ROLL UP with bottom line feed option is enabled, a character displayed in the right most position of the last line causes the screen to be rolled up one line within the roll window. The cursor is positioned at the first character position of the 24th line (bottom line of subscreen if the Subscreen option is enabled).

Auto Roll Up with Bottom Line Feed (AUTO ROLL)

The AUTO ROLL option causes the displayed data to move up one line when the cursor is on the 24th line (bottom line of subscreen if the Subscreen option is enabled) and a Line Feed control character is received.

If the AUTO ROLL option is enabled and the terminal receives a Line Feed control character while the cursor is on the 24th line (bottom line of subscreen), each displayed line moves up one line leaving the 24th line blank (bottom line of subscreen). The data previously displayed on the first line of the screen (top line of subscreen) will be lost.

If the AUTO ROLL option is disabled, the terminal will ignore Line Feed control characters received when the cursor is on the 24th line or bottom line of the subscreen.

Roll Down (ROLL DN)

The ROLL DOWN option causes displayed data to move down one line, leaving line one blank (top line of subscreen if Subscreen option is enabled). If the ROLL DOWN option is enabled, and a Roll Down control character is received, each displayed line will move down one line. Data previously displayed on line 24 (bottom line of subscreen) is lost. The cursor position is not affected.

If the ROLL DOWN option is disabled and a Roll Down control character is received, the workstation ignores the character.

Cursor Increment with Delete Character (PRINT DEL)

The PRINT DEL option selects alternate controls over cursor movement when it receives a Delete character (0177). If this option is enabled and a Delete character is received, the Delete symbol is displayed (displayed on the screen as a blank unless down-line loaded), and the cursor moves to the next character position.

If the PRINT DEL is disabled and a Delete character is received, the cursor position is not affected.

Workstation

8200

Continued....

Cursor Off (CURS OFF)

The CURSOR OFF option allows the host processor to turn the cursor on or off. If this option is enabled, the workstation will respond to the Cursor On or Cursor Off commands from the host processor. Cursor positioning will not be affected by those commands. If this option is disabled, the cursor is displayed whenever it is on the workstation screen or subscreen. Cursor On or Off commands are ignored while the CURSOR OFF option is disabled.

Bell on Printing Character 64 (BELL)

The BELL option allows the operator to select alternate controls over the sounding of the bell. If the bell option is enabled, the workstation sounds a bell whenever a character is displayed in the 64th character position of any line, and responds to the Bell character received from the host processor. If this option is disabled, the workstation sounds a bell only when the Bell character is received from the host processor.

3.6.1.5 Local Control Options

The Local Control Options include Local Display (half-duplex), Local Erase, Local Home, and Break.

Local Display (LOC DISP)

The LOCAL DISPLAY option provides an echo mode capability for the workstation. Characters generated by the keyboard may be displayed on the CRT screen as well as sent to the host processor. This option should only be selected when the host processor is not echoing characters back to the workstation.

If the LOCAL DISPLAY option is enabled, the workstation transmits system keycodes to the host processor and displays those keycodes on the screen. The workstation continues to display characters received from the host processor. If the Local Display option is disabled, the workstation transmits system keycodes to the host processor, but will display only those characters received from the host processor.

Local Erase (LOC ERASE)

The LOCAL ERASE option allows the operator to initiate the Erase to End of Frame function. This causes the screen to be erased from the current cursor position to the last line. If the LOCAL ERASE option is enabled, the workstation erases the screen from the current cursor position to the end of the frame whenever the operator depresses the erase key (key above CTRL key).

Transmit Erase (TX ERASE)

The TRANSMIT ERASE option allows the operator to transmit an EEOF system keycode to the host processor. If the TX ERASE option is enabled, the terminal generates an EEOF system keycode and transmits it to the host processor whenever the operator depresses the designated ERASE key (key above the CTRL key).

Local Home (LOC HOME)

The LOCAL HOME option permits the operator to move the cursor to the "home up" position (first character of first line). If the LOCAL HOME option is enabled, the cursor moves to the home up position whenever the operator depresses the HOME key (key below the CTRL key).

Transmit Home (TX HOME)

The TRANSMIT HOME option allows the operator to transmit a Home Up system key code whenever the operator depresses the designated Home key (key below the CTRL key).

Local Break (BREAK)

The LOCAL BREAK option generates a break condition at the 8200 Workstation. A break occurs when the transmit data line (pin 2) in the communications interface connector goes to the spacing condition (positive voltage: all data bits are zero) for a period of time longer than the normal character time. This condition is sometimes used as a means of signaling between devices that communicate serially.

If this option is enabled, the workstation generates a Break condition whenever the BREAK key is depressed. The duration of the Break condition is independent of the time length that the BREAK key is depressed. If this option is disabled, the workstation will take no local action when the BREAK key is depressed, but transmits whatever system keycode has been assigned to the key.

3.6.2 Diagnostic Mode

After the workstation has entered the Off-Line mode, the various diagnostic routines may be selected as follows:

While holding down the CTRL key,
Momentarily press the

M key for Memory Diagnostic
V key for Video Display Diagnostic
K key for Keyboard Loop Diagnostic
Y key for Interactive Keyboard Diagnostic
I key for Internal Loopback Diagnostic
E key for External Communications Diagnostic
L key for External Loopback Diagnostic
S key for Terminal Self-Test Diagnostic
D key for Serial Communications Diagnostic

Release the CTRL key.

After a diagnostic test has been run, another may be selected as described earlier. The diagnostic test can be terminated by holding down the CTRL key and pressing the CANCEL key or by repeating the off-line sequence to return to on-line operation. If an error is detected, the diagnostic test will be terminated.

3.6.2.1 Memory Diagnostic

The Memory Diagnostic tests the character generator and screen refresh RAM memories with rotating bit patterns. An LRC/SLRC test is performed on the ROM memory. The diagnostics identify memory errors to the chip level. The CRT display cannot be used during the character generator or screen RAM memory tests. The memory diagnostic maintains a six digit decimal pass counter.

If an error is detected, the diagnostic prints 'MEMERRn' on the top line of the screen, and returns to the off-line mode. The number (n) printed after the error message indicates what type of error was encountered. Listed below are the possible numbers found after the error message:

- 0 = Firmware ROM 0
- 1 = Unused
- 2 = Second 1K of screen RAM
- 3 = First 1K of screen RAM
- 4 = Character Generator RAM
- 5 = Firmware ROM 1 - Used in dual 4K version only
- 6 = Firmware ROM 2 - Future expansion usage only

3.6.2.2 Video Display Diagnostic

The Video Display Diagnostic begins by asking the operator for a character to be entered from the keyboard. That character is then printed in all positions on the screen. This diagnostic routine can be used to adjust the screen monitor.

3.6.2.3 Keyboard Loop Diagnostic

The Keyboard Loop Diagnostic provides a check on the proper functioning of the keyboard logic and connections between it and the workstation. This diagnostic routine transmits a series of characters to the keyboard and checks the characters that are echoed back. A six digit decimal pass counter is maintained. If an error is detected, the diagnostic prints KBDERR on the top line of the display and returns to the off-line mode.

3.6.2.4 Interactive Keyboard Diagnostic

The Interactive Keyboard Diagnostic requires an operator to press the keys in response to the diagnostic display. The diagnostic routine loads a U.S. ASCII character set and keyboard translate table and then prints a line of 64 characters on the top line of the workstation screen.

Workstation 8200

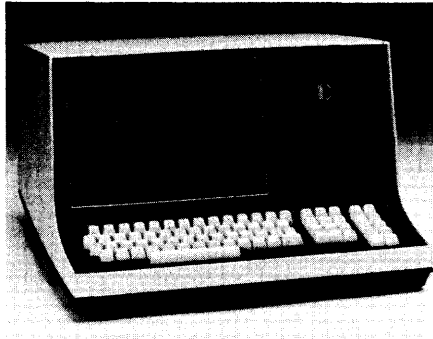

The operator must press every key from top row through bottom row, left to right, following the precise sequence displayed. If a wrong key is pressed, the cursor is not incremented to the next character, and a beep sounds. When testing the function keys, each function key generates both a down and an up code. Therefore, the cursor increments not only on key depression but on key release as well. The entire test should then be repeated with upper case characters.

The normal exit for the Interactive test is completion of the depression of all keys in the appropriate sequence. However, by pressing the CTRL key once and the INT key twice, the sequence aborts and returns the workstation to the on-line mode.

3.6.2.5 Internal Communications Diagnostic

The Internal Communications Diagnostic provides an internal communications loop back test of the communications logic. Characters are transmitted and received by the USART (Universal Synchronous/Asynchronous Receive/Transmit) and displayed on the screen. A six digit decimal pass counter is incremented and displayed through each pass of the diagnostic routine.

If an error is detected, COMERR is displayed on the top line of the screen, and the 8200 will re-enter the off-line mode.

3.6.2.6 External Communications Diagnostic

The External Communications Diagnostic allows the 8200 to receive data from the host processor and transmit it back. The data is displayed on the 8200 screen and routed to the local printer if available. A symbol is displayed for control characters received (Serial Communications Diagnostic fashion) and no function is performed. The diagnostic routine tests the communications channel between the processor and the 8200.

The diagnostic routine may be entered and exited only by local operator action. It supports split baud rate operation. In applications where the receive baud rate is higher than the transmit baud rate, the 8200 has a 1760 character FIFO buffer. This buffer allows the processor to send blocks of data with minimal timing overhead for the processor.

3.6.2.7 External Loopback Diagnostic

The External Loopback Diagnostic checks the RS-232-C drivers and receivers and internal cabling. A loop back plug must be installed on the communications receptacle at the rear of the 8200 for this test to be performed. This test should normally be done only by qualified service personnel. If an error is detected, COMERR is displayed on the top line of the screen and the 8200 re-enters the off-line mode.

3.6.2.8 Terminal Self-Test Diagnostic

The Terminal Self-Test Diagnostic executes the memory diagnostic, the internal communications diagnostic, and the keyboard loopback diagnostic. The display is active and a pass counter is maintained.

If errors are detected, the error counter displayed on the screen is incremented, and an error message is displayed. If more than one error is detected, the error message on the screen indicates the last error detected.

3.6.2.9 Serial Communications Diagnostic

The Serial Communications Diagnostic is similar to the External Communications Diagnostic except that characters received from the processor are displayed but are not sent back. If a character is keyed in from the keyboard, the character (if transmittable) is displayed and transmitted to the host processor. This process permits keyins while in the diagnostic mode and allows interactive communications testing. The keyed-in characters are displayed in inverse video.

3.6.3 Down-Line Configuration Commands

The 8200 Workstation responds to a Configuration Interrogate Command (CIC), a Configuration Load Command (CLC), and a Configuration Restore Command (CRC).

The CIC sequence allows the host processor to interrogate the workstation and determine the status of the configuration options. The CLC sequence allows the host processor to down-line load a temporary configuration option set. The down-line loaded set of options is stored in RAM memory, and the option data stored in nonvolatile memory is not altered. The workstation restores the original option configuration whenever it is powered down and then back up again, or when it is sent a Configuration Restore Command (CRC). The internal coding for the configuration option is detailed in Figure 3-10.

The CRC sequence permits the host processor to restore the workstation to its power up configuration, character set, and keyboard translation table. Each character of the CIC, CLC, CRC, LCGC, and/or LKTC must be received within 5 seconds from receipt of the preceding character. If each character is not received within the specified time period, the sequence is aborted.

3.6.3.1 Configuration Interrogate Command (CIC) Sequence

The host processor interrogates the status of the configuration option table in the workstation by means of the Configuration Interrogate Command Sequence. The command sequence is shown below:

CIC Sequence	Description
034	Down-line command
0105	CIC identification character
N _L	Dummy character (0100)
N _H	Dummy character (0100)
034	Down-line command character
0100	Termination character
CS1	Checksum character
CS2	Checksum character
CS3	Checksum character
CS4	Checksum character

Each character in this sequence (and the other sequences) has seven bits and (except for 034 from the host and 021 from the workstation) each character must be in the range 0100 to 0137. The checksum is actually two 8-bit bytes that are transmitted as the four least significant bits (LSB) of four characters. Checksum compilation begins with the Identification character and ends with the Termination character.

3.6.3.2 Configuration Interrogate Response Sequence

The 8200 Workstation responds to the CIC sequence by transmitting a 16 character Configuration Status Response (CSR) Sequence to the host processor. A description of this sequence is shown on the following page.

Workstation 8200

Continued...

CSR
Sequence Description

021	Down-lines response character
0101	CSR identification character
N _L	Dummy character (0100)
N _H	Dummy character (0101)
FLG0	Option flag 0
FLG1	Option flag 1
FLG2	Option flag 2
FLG3	Option flag 3
FLG4	Option flag 4
021	Down-line response character
0100	Termination character
CS1	Checksum character
CS2	Checksum character
CS3	Checksum character
CS4	Checksum character

The coding for the option flags is described in detail in Figure 3-10. Information concerning the baud rates and brightness setting is not provided to the host processor.

3.6.3.3 Configuration Load Command Sequence

The format of the CLC sequence is shown below:

CLC
Sequence Description

034	Down-line command character
0103	CLC identification character
N _L	Dummy character (0100)
N _H	Dummy character (0100)
FLG0	Option flag 0
FLG1	Option flag 1
FLG2	Option flag 2
FLG3	Option flag 3
FLG4	Option flag 4
034	Down-line command character
0100	Termination character
CS1	Checksum character
CS2	Checksum character
CS3	Checksum character
CS4	Checksum character

The option flag coding in the CLC sequence is the same as that in the CSR sequence (see Figure 3-10). Even though the bits which identify parity are transmitted and received, the workstation does not respond to a parity change command. Parity is only set following a power up operation or during Configuration Option mode operation. The host processor cannot change baud rates, brightness level, or the general purpose keyboard option configuration.

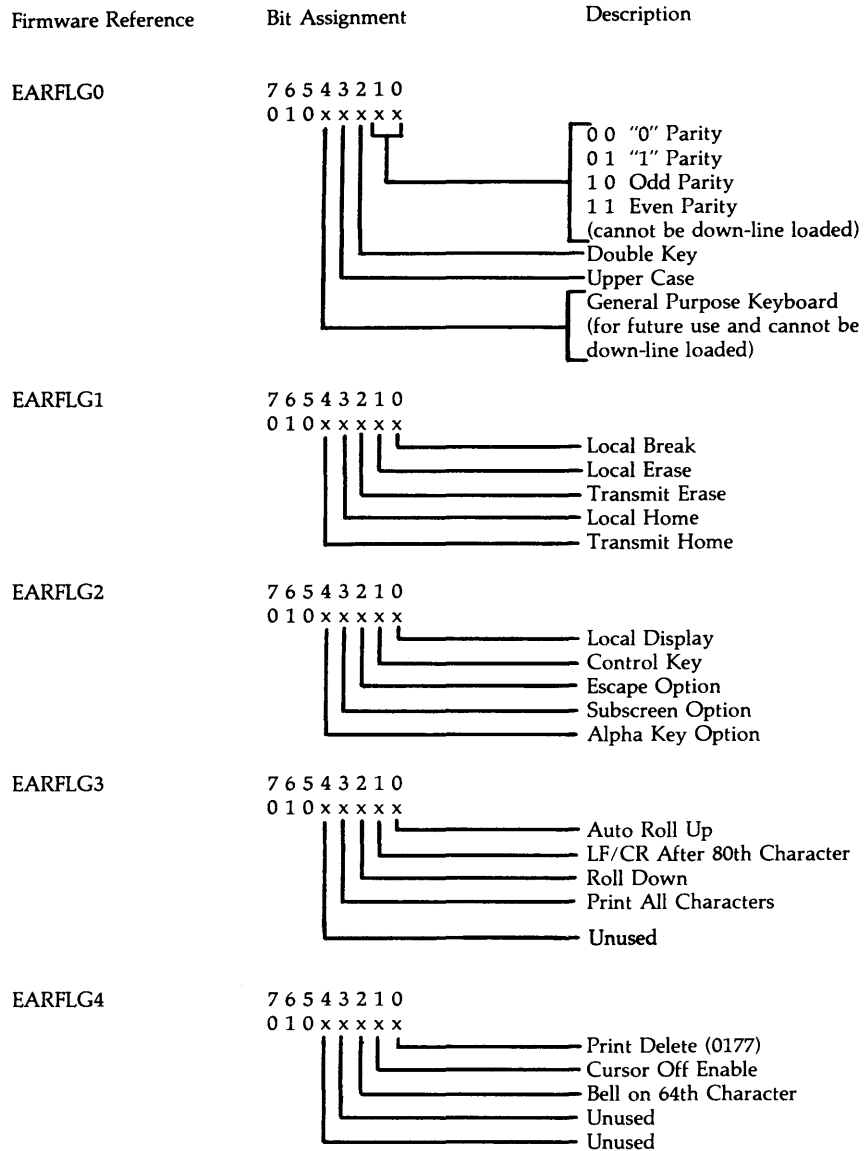

NOTE: EARFLG Range = 0100 to 0137

Figure 3-10: Configuration Option Flag Coding

3.6.3.4 Configuration Load Response

The 8200 Workstation responds to a Configuration Load Command sequence in two ways. Before performing any action on the Configuration Load Command data, the 8200 computes a checksum for the data received and compares it with the checksum characters received. If the checksums match, the configuration data is stored in RAM memory and the configuration status is transmitted to the host processor (See Section 3.6.3.6). If the checksums do not match, the load command is ignored and status is not transmitted to the host.

3.6.3.5 Configuration Restore Command

When the 8200 receives a Configuration Restore Command (CRC) from the host

processor, it sets the configuration options last specified either by a Configuration Load Command or during the Configuration Option Mode:

CRC
Sequence Description

034	Down-line load command character
0104	CRC identification character
N _L	Dummy character (0100)
N _H	Dummy character (0100)
034	Down line load command
0100	Termination character
CS1	Checksum character
CS2	Checksum character
CS3	Checksum character
CS4	Checksum character

Workstation 8200

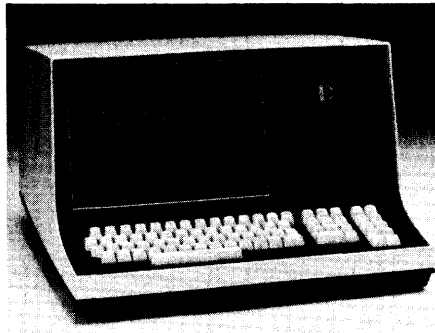

The Configuration Restore Command will be acknowledged by the 8200 if the checksum computed matches the checksum received.

Acknowledgement

- 021 Down-line response character
- 0100 Acknowledged character

3.6.3.6 Checksum Compilation

The checksum for each command consists of an LRC (Longitudinal Redundancy Character) byte and an SLRC (shift-right-circular Longitudinal Redundancy Character) byte computed and transmitted as described below.

Checksum Algorithm

1. Clear LRC and LSRC registers.
2. For each character transmitted, compute the binary exclusive-or of the LRC and the character and load the result in the LRC.
3. For each character transmitted, compute the binary exclusive-or of the SLRC and the received character. Then shift the 8-bit result to the right one place (shift right circular), and load the result in the SLRC.
4. At the end of the character string encode the LRC and SLRC as follows:

CS1 = 0100 plus the four least significant bits of the LRC.

CS2 = 0100 plus the four most significant bits of the LRC.

CS3 = 0100 plus the four least significant bits of the SLRC.

CS4 = 0100 plus the four most significant bits of the SLRC.

5. Check validity by comparing the computed checksums with the received checksums.

An example of an algorithm to validate checksums is shown below in Figure 3-11.

DE 000	Clear LRC and SLRC registers, D and E, respectively.
•	
•	
•	Assume character in A register
•	
LBA	Store character in B register
XRD	Exclusive-or with LRC store
LDA	Put new LRC value back in D register
LAB	Get character back
XRE	Exclusive-or with SLRC register
SRC	Perform circular shift
LEA	Put new SLRC back in E register
•	
•	
•	
•	

Figure 3-11: Sample Checksum Algorithm

3.7 Down-Line Loaded Character Sets

The 8200 Workstation will accept down-line loaded character sets from the host processor. The processor prepares the 8200 to receive the character set data by sending a Configuration

Load Command sequence. The 8200 will then accept character set data until the first non-character set data is received.

Character set data may be altered by a Load Character Generator RAM Command sequence (LCGC). System keycodes may be changed by a Load Keyboard Translate Table Command sequence (LKTC). The 8200 will store the data received and transmit a Load Response sequence to the host processor.

3.7.1 Load Character Generator RAM Command Sequence

The Datapoint processor may load each character with a separate LCGC or it may load a contiguous string of characters with a single LCGC. The address for each character corresponds to the ASCII code for that character. Each character in the command sequence contains four or five bits of significant data and is masked with an octal 0100 to make a 7-bit character (except for the command character). The 8200 Workstation uses an octal 0101 for the terminal identification character. A description of the LCGC sequence is shown below.

LCGC Description

034	Down-line command character
0101	LCGC identification character
N _L	Four least significant bits of the first character address plus 0100
N _H	Four most significant bits of the first character address plus 0100
C1	Top row character display dot
C2	Row 2 character display dot
C3	Row 3 character display dot
C4	Row 4 character display dot
C5	Row 5 character display dot
C6	Row 6 character display dot
C7	Row 7 character display dot
•	Additional groups of character display dots for contiguous character address
•	
•	
034	Down-line command character
0100	Termination character
CS1	Checksum character
CS2	Checksum character
CS3	Checksum character
CS4	Checksum character

Figure 3-12 contains an example of the Load Character Generator RAM Command sequence for loading character 'B'.

The 8200 computes a checksum for the data it receives and the checksum is compared with the checksums received. If the checksums match, the 8200 transmits an acknowledgement to the Datapoint processor:

Acknowledgement

- 021 Down-line load response character
- 0100 Acknowledgement character

If the checksums do not match, the 8200 does not acknowledge the LCGC. If the host processor does not receive a response from the 8200 following a LCGC, it should transmit a CRC sequence to restore the 8200 to its power up configuration and character sets. The processor must then repeat the entire down line load sequence.

Load character 'B' in address 0102

Octal	Binary	Description
	6 5 4 3 2 1 0	
034	0 0 1 1 1 0 0	Down-line load command
0101	1 0 0 0 0 0 1	Identification
0102	1 0 0 0 0 1 0	NL
0104	1 0 0 0 1 0 0	NH
0136	1 0 1 1 1 0 0	Dot Matrix
0121	1 0 1 0 0 0 0	
0121	1 0 1 0 0 0 0	
0136	1 0 1 1 1 0 0	
0121	1 0 1 0 0 0 0	
0121	1 0 1 0 0 0 0	
0136	1 0 1 1 1 0 0	
034	0 0 1 1 1 0 0	Command
0100	1 0 0 0 0 0 0	Termination
0105	1 0 0 0 1 0 1	CS1
0104	1 0 0 0 1 0 0	CS2
0113	1 0 0 1 0 1 1	CS3
0111	1 0 0 1 0 0 1	CS4

Figure 3-12: Load Character Generator RAM Command Sequence Example

Workstation 8200

Continued....

The LRC for loading character B is the binary exclusive-or of the LCGC code from the LCGC Identification character to the Termination character, inclusive. The binary exclusive-or of those characters must match the byte composed of the four least significant bits of CS2 and CS1:

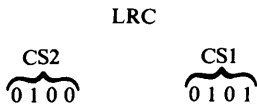

The SLRC for loading character B is the shifted right binary exclusive-or of the LCGC code from the Identification character to the Termination character, inclusive. The shifted right circular sum of those characters must match the byte composed of the four least significant bits of the CS4 and CS3:



3.7.2 Load Keyboard Translate Table Command Sequence

The host processor may load each entry in the keyboard translate table with a LKTC, or it can load a contiguous string of entries with a single LKTC. The address for each table entry is the key code generated by the keyboard for a key switch depression. The LKTC sequence is described in the next column.

LKTC	Description
034	Down-line command character
0102	LKTC identification character
N _L	Four least significant digits of the first keyboard address
N _H	Four most significant digits of the first keyboard address
KCODES	Status of key value
KCODEL	Four least significant digits of key value
KCODEH	Four most significant digits of key value
.	Additional contiguous keyboard translate table entries
034	Down-line command character
0100	Termination character
CS1	Checksum character
CS2	Checksum character
CS3	Checksum character
CS4	Checksum character

The 8200 responds to receipt of the LKTC in the same manner it responds to receipt of LCGC (see Section 3.6.1).

Figure 3-13 contains an example of the Load Keyboard Translate Table Command sequence for loading keyboard address 0102 with key value 0102.

Load keyboard address 0102 with key value 0102 and activate display and transmit bits.

Octal	Binary	Description
	6 5 4 3 2 1 0	
034	0 0 1 1 1 0 0	Command
0102	1 0 0 0 0 1 0	Identification
0102	1 0 0 0 0 1 0	N _L
0104	1 0 0 0 1 0 0	N _H
0103	1 0 0 0 0 1 1	KCODES
0102	1 0 0 0 0 1 0	KCODEL
0104	1 0 0 0 1 0 0	KCODEH
034	0 0 1 1 1 0 0	COMMAND
0100	1 0 0 0 0 0 0	Termination
0115	1 0 0 1 1 0 1	CS1
0105	1 0 0 0 1 0 1	CS2
0106	1 0 0 0 1 1 0	CS3
0104	1 0 0 0 1 0 0	CS4

Figure 3-13:
Load Keyboard Translate Table Command Sequence Example

KCODES = 1000FDT
KCODEL = 100LLLL
KCODEH = 100HHHH

KCODE Bit Definitions:

- F 1= Local Function Key (only Local Home, Erase, or Break
0= Not a Local Function Key
- D 1= Displayable Character
0= Nondisplayable Character
- T 1= Transmittable Character
0= Nontransmittable Character

The LRC for loading keyboard address 0102 with key value 0102 is the binary exclusive-or of the LKTC code from the Identification character through the Termination character, inclusive. The binary exclusive-or of those characters must match the byte composed of the four least significant bits of CS2 and CS1:

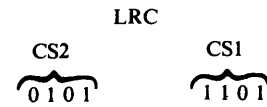

The SLRC for loading keyboard address 0102 with key value 0102 is the shifted right circular binary exclusive-or of the LKTC code from the Identification character through the termination character, inclusive. The shifted right circular binary exclusive-or of those characters must match the byte composed of the four least significant bits of CS4 and CS3:

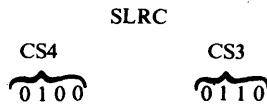

Figure 3-14 contains a numbered switch location for the Universal Keyboard. Figures 3-15A and 3-15B show the keycode switch addresses and the octal code emitted by each key address. Each octal code shown signifies the untranslated code sent to the logic assembly. These are the keyswitches and keycodes that will be changed when using the LKTC sequence.

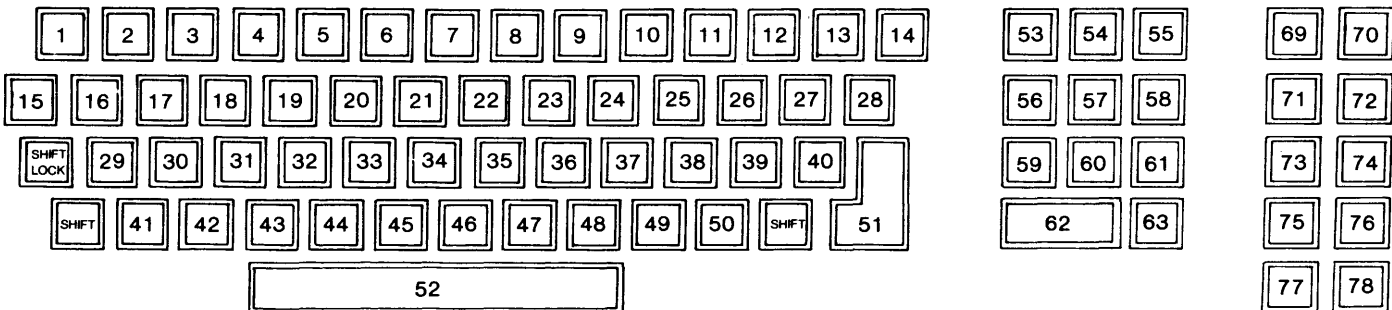
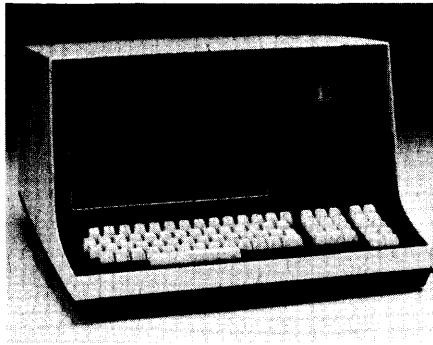

Figure 3-14: Numbered Switch Location

Workstation 8200



Datapoint 8200 Workstation

Figure 3-15A:

Untranslated Keycodes Sent On Depression From Keyboard (All keycodes are in octal notation)

"S": preceding a key switch number indicates the shift function.

Key Keycode	Key Keycode	Key Keycode	Key Keycode
1 061	17 0167	33 0147	49 056
S1 041	S17 0127	S33 0107	S49 076
2 062	18 0145	34 0150	50 057
S2 042	S18 0105	S34 0110	S50 077
3 063	19 0162	35 0152	51 015
S3 043	S19 0122	S35 0112	S61 0215
4 064	20 0164	36 0153	52 040
S4 044	S20 0124	S36 0113	S52 040
5 065	21 0171	37 0154	53 0267
S5 045	S21 0131	S37 0114	S53 0367
6 066	22 0165	38 073	54 0270
S6 046	S22 0125	S38 053	S54 0370
7 067	23 0151	39 072	55 0271
S7 047	S23 0111	S39 052	S55 0371
8 070	24 0157	40 0135	56 0264
S8 050	S24 0117	S40 0175	S56 0364
9 071	25 0160	41 0172	57 0265
S9 051	S25 0120	S41 0132	S57 0365
10 060	26 0140	42 0170	58 0266
S10 000	S26 0100	S42 0130	S58 0366
11 055	27 0134	43 0143	59 0261
S11 075	S27 0174	S43 0103	S59 0361
12 0137	28 0136	44 0166	60 0262
S12 0177	S28 0176	S44 0126	S60 0362
13 0133	29 0141	45 0142	61 0263
S13 0173	S29 0101	S45 0102	S61 0363
14 0100	30 0163	46 0156	62 0260
S14 0210	S30 0123	S46 0116	S62 0360
15 033	31 0144	47 0155	63 0256
S15 0233	S31 0104	S47 0115	S63 0256
16 0161	32 0146	48 054	
S16 0121	S32 0106	S48 074	

Key Keycode	Key Keycode
69D 0300	74D 0305
69R 0320	74R 0325
S69D 0340	S74D 0345
S69R 0320	S74R 0325
70D 0301	75D 0306
70R 0321	75R 0326
S70D 0341	S75D 0346
S70R 0321	S75R 0326
71D 0302	76D 0307
71R 0322	76R 0327
S71D 0342	S76D 0347
S71R 0322	S76R 0327
72D 0303	77D 0310
72R 0323	77R 0330
S72D 0343	S77D 0350
S72R 0323	S77R 0330
73D 0304	78D 0311
73R 0324	78R 0331
S73D 0344	S78D 0351
S73R 0324	S78R 0331

Figure 3-15B:

Untranslated Keycodes Sent on Depression/Release From Keyboard

(All keycodes are in octal notation)

"D": following a key switch number indicates a code sent on depression.

"R": following a key switch number indicates a code sent on release.

"S": preceding a key switch number indicates the shift function.

4.0 Physical Description

The 8200 Workstation consists of a CRT and keyboard mounted in a case designed to rest on a desk or table top. The Workstation is available with either a fixed or detached keyboard. Figure 4-1 contains a dimensional view of the Model 8200 Workstation with a fixed keyboard. Figure 4-2 shows the dimensional view of the Model 8211 Workstation with a detached keyboard.

Model 8200

Height: 11.50 inches (29.2 cm) Front
9.50 inches (19.2 cm) Rear
Width: 18.50 inches (47.0 cm)
Depth: 19.50 inches (49.5 cm)
Weight: 30 pounds (16.5 Kg)

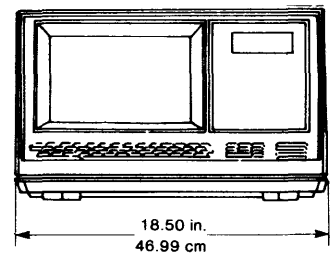
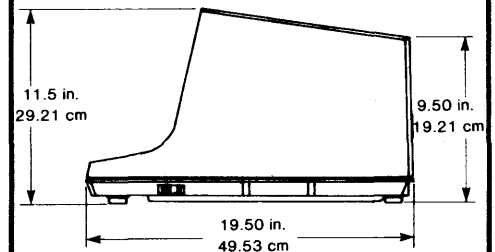

Figure 4-1: Model 8200 with a fixed keyboard

Workstation 8200

Continued....

Model 8211

Height: 12.4 inches (31.5 cm) Front
10.4 inches (36.5 cm) Rear
Width: 20.0 inches (50.8 cm)
Depth: 22.7 inches (58.0 cm)
Weight: 54 pounds (24.3 Kg)

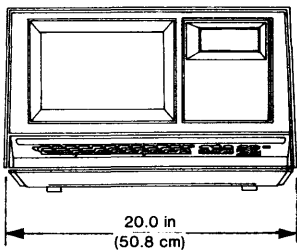
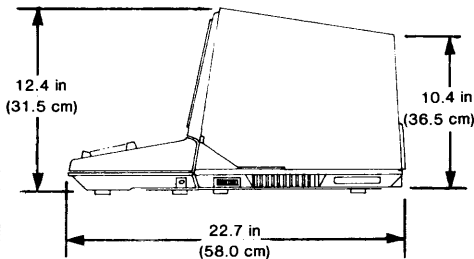

Figure 4-2:
Model 8211 with a detached keyboard

5.0 Environmental Requirements

TEMPERATURE: 50 to 100 degrees F
(10 to 38 degrees C)
HUMIDITY: 10 to 90% non-
condensing
HEAT DISSIPATION: 232 BTU/Hour (No fan
required)

Warning: This equipment generates, uses, and can radiate radio frequency energy and if not installed and used in accordance with the instructions manual, may cause interference to radio communications. It has been tested and found to comply with the limits for a Class A computing device pursuant to Subpart J of Part 15 of FCC Rules, which are designed to provide reasonable protection against such interference when operated in a commercial environment. Operation of this equipment in a residential area is likely to cause interference in which case the user at his own expense will be required to take whatever measures may be required to correct the interference.

6.0 Interface Requirements

SERIAL DATA: Signal levels: RS-232-C
(Input and Output) and CCITT v.24

CONNECTOR TYPE: Amphenol 50 pin

6.1 Primary Power

The 8200 Workstation, as supplied from Datapoint, will operate at 120 VAC. However, internationally the 8200 Workstation is field configurable for operation with input voltages of 100, 120, 220, 230, or 240 VAC at a frequency of 50 or 60 Hz +/-20%.

Current : 0.5 amps @ 120 VAC.

6.2 Connector Pin Assignments

Pin	Signal
1	Ground
2	Transmit data
3	Ground
4	Receive data
5	Ground
6	Not used
7	Ground
8	Printer data
9	Ground
10	Not used
11	Ground
12	Data terminal
13-49	Not used
50	Chassis ground

7.0 Options

The brightness level of the 8200 display can be adjusted by the operator. Holding the CTRL key down and pressing the key above it will cause brightness to increase one level. Holding the CTRL key down and pressing the key below it will cause brightness to decrease one level.

7.1 Configuration Option Mode

An array of options are available to programmer and operator through the Configuration Option Mode. Options which may be specified include the following:

- Receive Baud Rate
- Transmit Baud Rate
- Parity (0 or 1, odd or even)
- Double Key
- Upper Case Break
- Local Erase
- Transmit Erase
- Local Home
- Transmit Home
- Local Display Control Key
- Auto Roll
- Auto CR/LF
- Roll Down

- Print All
- Print Del
- Cursor Off
- Bell
- Escape Option
- Subscreen Option
- Alpha Option

- General Purpose Keyboard Option (future use)
- Word Processing Repeat Option (future use)

7.2 8200 Keyboard Options

8200: Fixed Keyboard
8211: Detached Keyboard

8.0 Shipping List

The following items are shipped with each 8200 Workstation:

Quantity	Item
1	8200 Workstation
1	Power Cable
1	8200 Product Specification (Document No. 60786)
1	Guide to Operating the 8200 (Document No. 60788)

NOTE: This shipping list is offered for information only; the current Datapoint Shipping List prevails in all cases.