



ACS-77100 RAID controller User Manual

Preface 3

 Notice..... 3

 Trademarks 3

 About This document 4

 Symbols used in this document 4

1. Introduction to the ACS-77100 5

 1.1. Overview 5

 1.2. System Structure 5

 1.3. Understanding RAID Levels 6

 1.3.1. RAID 0 (striping) 6

 1.3.2. RAID 10 (striping and mirroring) 7

 1.3.3. RAID 5 (striping with parity) and RAID 5+hot spare 8

2. Build a RAID Solution 9

 2.1. Hardware Requirement:..... 9

 2.2. LCD Panel Operations 10

3. Set up the RAID solution..... 11

 3.1. Setting the RAID Level 11

 3.1.1 RAID Level configurations 12

 3.2. Creating an Array 13

 3.2.1 Enable/Disable Over 2TB capacity 13

 3.2.2 Creating an Array 13

 3.3. Setting the Time and Date by LCD 14

 3.4. Connecting ACS-77100 to the Host computer 15

 3.5. Formatting and Partitioning the ACS-77100 15

 3.5.1. Windows Users 15

 3.5.2. Formatting drive over 2TB capacity on Windows Vista 17

4. Management 18

 4.1. LCD displayed Messages 18

 4.1.1. Booting Messages 18

 4.1.2. Set over 2TB Capacity Messages 18

 4.1.3. Initialization Messages 19

 4.1.4. System Ready Messages 19

 4.1.5. Rebuild Messages 20

 4.1.6. Error Messages 20

 4.2. StorConn GUI introduction 21

 4.2.1. RAID status monitoring window 22

5. Update Firmware 23

5.1. Firmware updating steps	23
6. Trouble Shooting	26
7. FAQ.....	27
8. Contact Accusys	28
Accusys, Inc.....	28
Accusys U.S.A., Inc.	28
Accusys China, Inc.....	28
Accusys EU B.V	29
Accusys Korea, Inc.	29

Preface

Notice

Product features and specifications described in this manual are subject to change without notice.

The manufacturer shall not be liable for any damage, or for the loss of information resulting from the performance or use of the information contained herein.

Trademarks

Accusys and the names of Accusys products and logos referenced herein are trademarks and/or service marks or registered trademarks and/or service marks of Accusys, Inc.

Microsoft, Windows, Windows NT, MS-DOS are either trademarks or registered trademarks of Microsoft Corporation. Intel and Pentium are registered trademarks of Intel Corporation. Other product and company names mentioned herein may be trademarks and/or service marks of their respective owners.

All contents of this manual are copyrighted by Accusys. The information contained herein is the exclusive property of Accusys, Inc. and shall not be copied, transferred, photocopied, translated on paper, film, electronic media, or computer-readable form, or otherwise reproduced in any way, without the express written permission of Accusys Inc.

Manual version 1.0

© Copyright 2006 Accusys, Inc.

All rights reserved.

About This document

This document discusses how to properly design your RAID solution when using the ACS-77100 RAID controller, and guides you to configure the RAID controller. Customer should have a working knowledge of RAID planning and data storage.

Symbols used in this document

Important information that users should be aware of is indicated with the following icons:



Caution

This icon indicates the existence of a potential hazard that could result in personal injury, damage to your equipment or loss of data if the safety instruction is not observed



Note

This icon indicates useful tips on getting the most from your RAID controller.

1. Introduction to the ACS-77100

1.1. Overview

The ACS-77100 RAID controller provides RAID 0 (striping), RAID 10 (Striping and mirroring) and RAID 5 (striping with parity) for you to construct a disk array optimized for performance or reliability. By connecting the SATA cables between the ACS-77100 and the disks, a RAID solution can be easily built.

The ACS-77100 controller is equipped with Java-based GUI (graphical user interface) monitoring program, by which users can easily monitor the RAID status from web browsers at a remote site. The monitoring program is also capable of sending out notification mail to users so that users can always be informed of the updated status of the device.

1.2. System Structure

An internal or external RAID subsystem can be built by integrating RAID controller (with LCD module), back-plane (or disk board for disk hot-swapping), connectors for out-band connection (eSATA/SATA host connector, DB9 connector for COM port), a selector for RAID level configuration, power supply, fan and all internal cables. Customer should provide the materials beside the RAID controller.

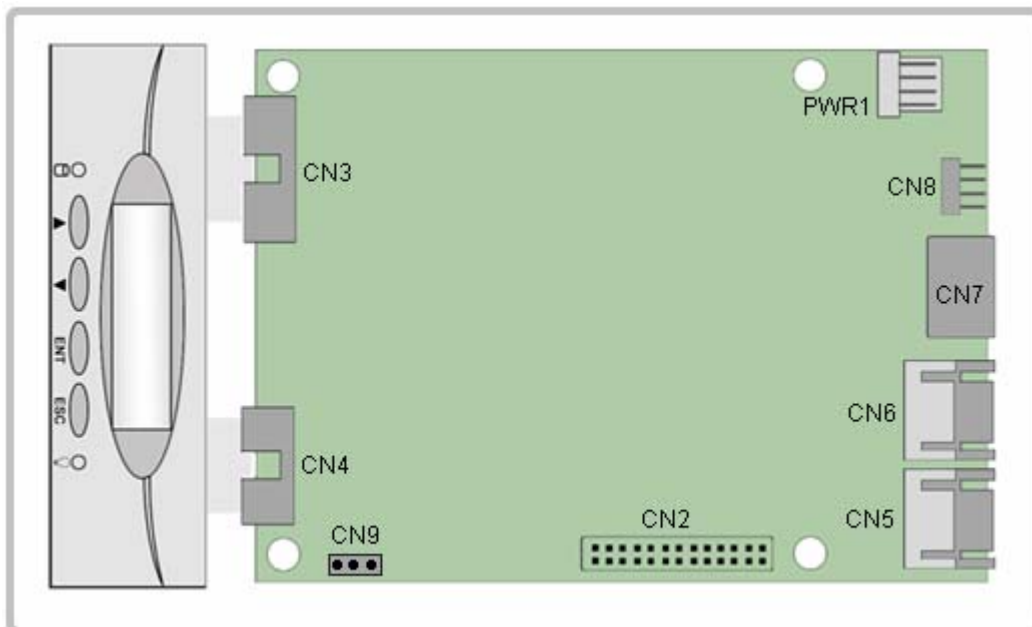

PWR1	Power connector	CN4	Button connector	CN7	Host I/F
CN2	BP I/F (LED, I2C)	CN5	Disk I/F	CN8	COM and RAID configuration I/F
CN3	LCD connector	CN6	Disk I/F	CN9	FAN connector

1.3. Understanding RAID Levels

1.3.1. RAID 0 (striping)

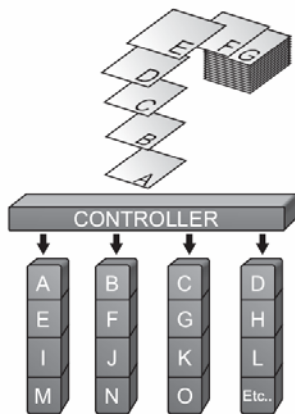

RAID 0 links each drive in the array to form one large drive. Storage capacity is determined by the smallest drive in the array. This capacity is then applied to format all other drive in the array.

When using a 40GB, 50GB and a 60GB drive in a RAID 0 array, your system will have, in effect, one 120GB drive (40GB x 3)

The diagram above represents the writing of data on a RAID 0 array composed of four disks connected to the controller. Data block are distributed across all disks in the array.

Characteristics

- RAID 0 implements a striped disk array, the data is broken down into blocks and each block is written to a separate disk drive.
- I/O performance is greatly improved by spreading the I/O load across many channels and drives.
- Fastest and most efficient array type but offers no fault-tolerance.

Recommended Uses

- Video production and editing.
- Image editing.
- Pre-press applications.
- Applications requests high-bandwidth.

1.3.2. RAID 10 (striping and mirroring)

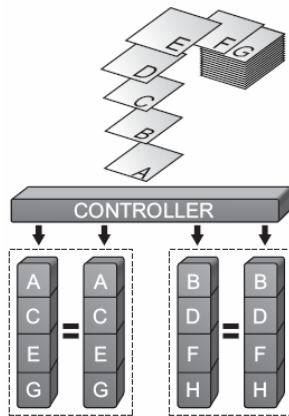

RAID 0+1 combines mirroring and striping functions on a minimum of four hard disks. Mirroring provides full redundancy and protects data in case of multiple drive failure (providing that data on one of each mirrored pair of drives is intact).

The diagram shown represents the writing of data on a RAID 0+1 array composed of four DISKS connected to the controller. The controller creates two matching RAID 0 arrays on four DISKS

Characteristics

- This configuration provides optimal speed and reliability.
- Requires even number of disks (minimum 4 disks)

Recommended Uses

- Imaging application.
- General Fileserver.

1.3.3. RAID 5 (striping with parity) and RAID 5+hot spare

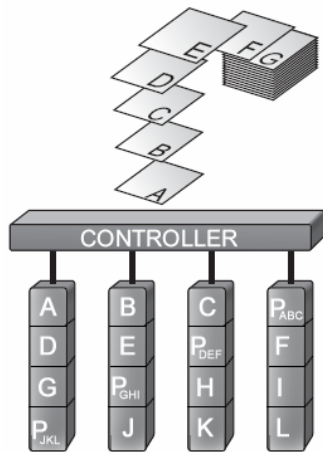

RAID 5 uses a mathematical expression that compares data from three drives and calculates a fourth piece of data called "parity" which is saved on a fourth drive. Should one of the drives failed, parity data can be used to rebuild the failed data. Under RAID 5, parity data is stored across all drives in the array. This maximizes the amount of storage capacity available from all drives in the array while still providing data redundancy. RAID 5 requires at least three drives. The ACS-77100 allows user to set RAID 5 with three drives and the fourth drive as a hot-spare drive ready to be used for rebuilding data in case one of the other drives fails.

The diagram above represents the writing of data on a RAID 5 array composed of four disks connected to the controller. Parity blocks are represented by the letter P

Characteristics

- Each entire data block is written on a data disk. Parity for blocks in the same rank is generated on Writes, recorded in a distributed location and checked on Reads.
- Highest Read data transaction, medium Write data transaction rate.
- Relatively low ratio of ECC (Parity) disks to data disks means high efficiency (compared to other RAID levels).
- Good aggregate transfer rate.

Recommended Uses

- File and application servers.
- Database servers.
- Web, Email servers.
- Internet server

2. Build a RAID Solution

This chapter covers the installation of the ACS-77100. The customers will be guided to using ACS-77100 to build a RAID solution.

2.1. Hardware Requirement:

- ACS-77100 RAID controller
- Backplane or Disk I/O board
- Disk carriers (with LED Indicators)
- Power supply
- Fan module
- Chassis
- Other materials
 - SATA disk cable
 - Header to DB9 cable
 - SATA to eSATA internal cable
 - Selector (with header connector + cable)

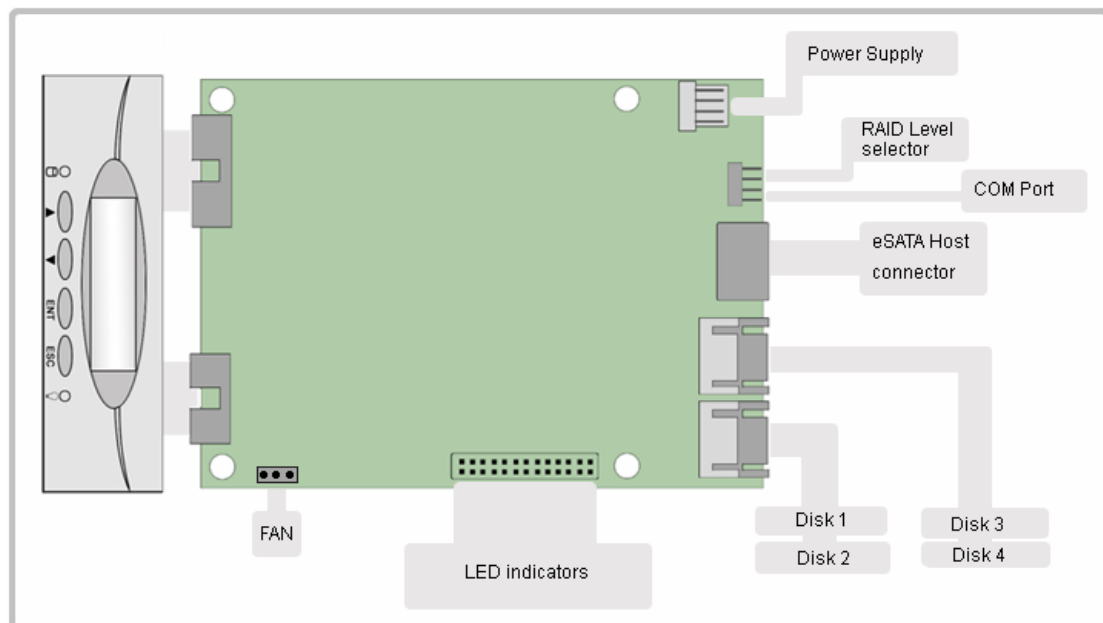

2.2. LCD Panel Operations

The LCD messages are displayed on the screen of LCD panel for system status.

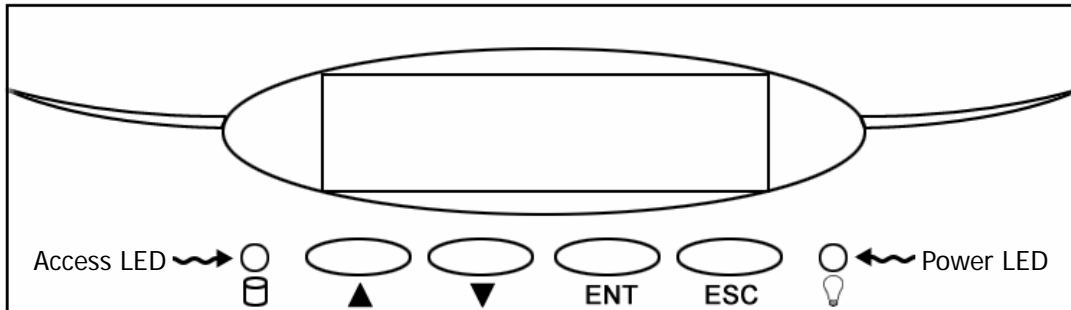

▲: Scroll up button ▼: Scroll down button ENT: Enter button ESC: ESC button

Scroll up button: to scroll up message data.

Scroll down button: to scroll down message data.

Enter button: to confirm or enter your selection.

ESC button: back to the top layer of message data.

3. Set up the RAID solution

This chapter covers the configuration of the ACS-77100. Through an easy process, the customers will be guided to configure the ACS-77100 through the following steps:

Step 1	3.1. Setting the RAID level – The ACS-77100 is per-configured at RAID level 5, but you have the option of customizing your RAID level in this step
Step 2	3.2. Creating an Array – The disks in ACS-77100 will be used to create an array, by which you can partition and use the storage.
Step 3	3.3. Setting the Date and Time – Configure your ACS-77100 for your local use.
Step 4	3.4. Connecting to a Host computer – Connecting the ACS-77100 to your host computer through eSATA interface.
Step 5	3.5. Formatting and Partitioning the ACS-77100 – This section details the process for formatting and partitioning the ACS-77100 on Windows operating system.

3.1. Setting the RAID Level

The RAID level of ACS-77100 is set using jumper heads on the RAID Configuration Interface (Pin1, 3, 5, 7 of the CN8). The four possible combinations of the jumper position correspond to the four available RAID settings: 0, 0+1, 5 and 5+spare.



Caution

The ACS-77101 must be powered off to change the RAID level.



Caution

If there is data on the array, changing the RAID level will cause loss of all the data on the array.

3.1.1 RAID Level configurations

RAID Level 5	RAID Level 0
<p>Pin1-3 is open. Pin5-7 is open.</p> <p style="text-align: center;">2 4 6 8</p> <div style="text-align: center;"> </div> <p style="text-align: center;">1 3 5 7</p>	<p>Pin1-3 is short. Pin5-7 is short.</p> <p style="text-align: center;">2 4 6 8</p> <div style="text-align: center;"> </div> <p style="text-align: center;">1 3 5 7</p>
RAID Level 10	RAID Level 5 + spare
<p>Pin1-3 is short. Pin5-7 is open.</p> <p style="text-align: center;">2 4 6 8</p> <div style="text-align: center;"> </div> <p style="text-align: center;">1 3 5 7</p>	<p>Pin1-3 is open. Pin5-7 is short.</p> <p style="text-align: center;">2 4 6 8</p> <div style="text-align: center;"> </div> <p style="text-align: center;">1 3 5 7</p>

Note

If the RAID level is not matched between the disk setting and the RAID level selector setting, the LCD will display the following two messages alternatively:

- (1) "RAID level"
"Unmatched"
- (2) "Current: R(X)" (i.e. the current RAID level setting of RAID level selector.)
"Original: R(Y)" (i.e. the original RAID level setting of the installed disks.)



Solution:

At this situation, RAID cannot work, users should choose one of the following options :

- (1) Shut down and tune the RAID level selectors to R(Y).
- (2) Re-plug the four disks and re-create the Array to R(X). (But data in the RAID will be lost due to the destructive initialization)

3.2. Creating an Array

3.2.1 Enable/Disable Over 2TB capacity

ACS-77100 supports over 2TB capacity. The steps below will guide you to enable/disable over 2TB capacity.

1. Select scroll button to find the capacity setting item on LCD panel. (**P.18, 4.1.2. Set over 2TB capacity Messages**)
2. Press the **ENT** button, and select (YES) or (NO) by the scroll buttons.



Note

If you want to create the array with over 2TB capacity, the setting must be finished before to create an array.

3. Press the **ENT** button to confirm the setting.

3.2.2 Creating an Array

The steps below will guide you to create an array on the ACS-77100.

1. Configure RAID level.
2. Power on the ACS-77100 without disks installed.
3. Install 4 disks on ACS-77100.
4. After ACS-77100 recognized all disks. A message 「**Create New RAID?**」 will be displayed on the LCD panel.
5. Select 「**YES**」 by the scroll buttons and press the **ENT** button to create array.



Note

During the RAID-creating procedure, the percentage of RAID initialization progress will be displayed on the LCD panel.



Note

The initialization process is a time-intensive process and is dependent upon the size of the disks. For example, four 400GB disks in a RAID 5 array could take over about two hours.



Note

The device over 2TB capacity should be supported by Operation System (e.g. Windows Vista). Please refer to section **3.5. Formatting and Partitioning the ACS-77100** to partition the device.

3.3. Setting the Time and Date by LCD

To change the time and date on the LCD, press and hold the **ENT** button for five seconds. Release the button to display the date and time setting screen.

To adjust the time and date values, use the **Scroll** buttons to change the values. (Figure 3.3.A) Press the **ENT** button to confirm your selection and move to next value.

Start by adjusting the year (YY), then move to the month (MM), the day (DD), and finally the hour (HH) and minute (MM).

Pressing the **ENT** button on the final selection will set the time and date. The Time and Date will be displayed on the LCD during ACS-77100 stand-by mode. (Figure 3.3.B)

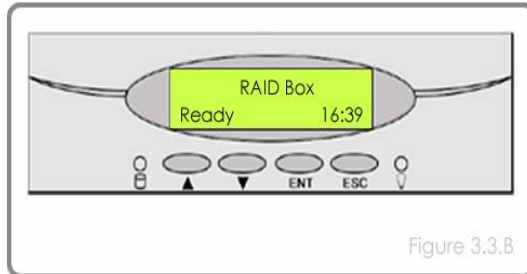
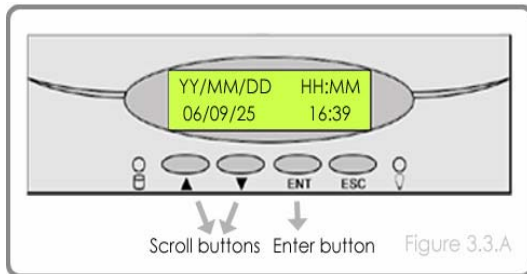

Note

The time is measured in the 24-hour clock format.

3.4. Connecting ACS-77100 to the Host computer

1. Follow the steps on page 11, **3.1. Setting the RAID Level** and 13, **3.2. Create an Array** to establish a RAID.
2. Connect an end of the eSATA cable into the eSATA port on the ACS-77100 RAID subsystem.
3. Connect the other end of the eSATA cable into the eSATA port on the host computer.

It will take a few seconds for the host computer to recognize the drive for it to appear in **My Computer** or on the desktop.

The ACS-77100 RAID subsystem will now need to be formatted. Go to next step **3.5. Formatting and Partitioning the ACS-77100** for more information.

3.5. Formatting and Partitioning the ACS-77100

Before the ACS-77100 array can be fully utilized, it needs to be formatted. During this process, the array can also be customized with partition. As you format the drive, you will have the opportunity to divide the hard drive into sections, called partitions. A partition is a section of the hard drive's capacity that is created to contain file and data.

3.5.1. Windows Users

**Caution**

Before beginning the format and partition, make sure there are no any warning or error message being displayed on the ACS-77101 LCD displayed.

After having followed the steps to set the RAID level, create an array and connect the interface cable to the host computer, the ACS-77100 must now be formatted and partitioned before it can be used.

1. Right click **My Computer** and click **Manage**.
2. From the **Computer Management** window, select **Disk Management**. (Figure 3.5.1.A)
3. If the **Initialize and Convert Disk Wizard** window appears, click **Cancel**.

4. Windows operation system will list all the hard drives that are installed on the system. Locate the ACS-77100 drive that is represented by the  icon. Right click the icon and select **Initialize**.
5. In the drive box to the right shows **Unallocated**, right click and select **New Partition**. (Figure 3.5.1.B)

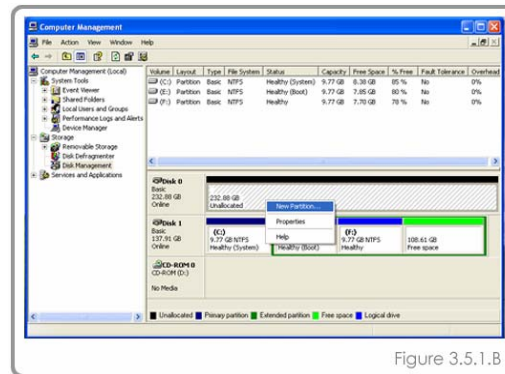
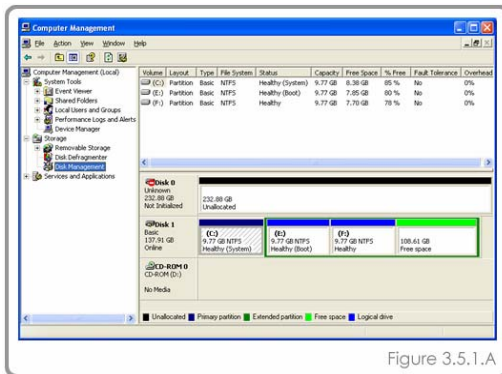

6. The **New Partition Wizard** dialog box will appear, click **Next** to continue. (Figure 3.5.1.C)
7. After selecting partition type, specifying partition size and assigning drive letter, the **Format Partition** dialog box (Figure 3.5.1.D) will appear, you have the option of selecting the **Quick Format** option. This allow mach fast formatting, however, this disallow Disk Management to check the drive sector for errors. Click Next to start the format process.
8. Your drive should now appear in your **My Computer** and ready for use.

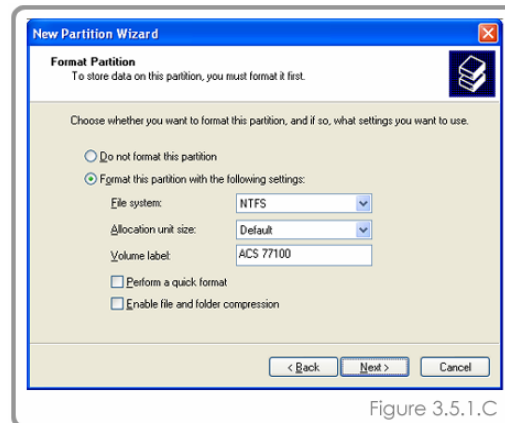
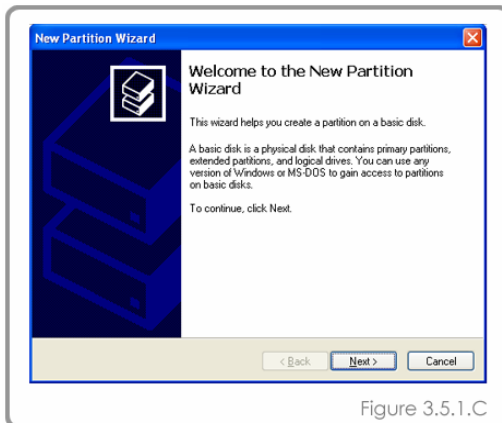



Caution
Formatting drive will crash all data in the drive.

3.5.2. Formatting drive over 2TB capacity on Windows Vista

The steps below will guide you to format a drive over 2TB capacity on Window Vista.

1. Right click **Computer** and click **Manage**.
2. From the **Computer Management** window, select **Disk Management**.
3. Windows operation system will list all the hard drives that are installed on the system. Locate the ACS-77100 drive that is represented by the  icon. Right click the icon and select **Initialize Disk**.
4. The **Initialize Disk** dialog box will appear, select the disk number and select the **GPT (GUID Partition Table)** partition style. (Figure 3.5.2.A)
5. In the drive box to the right shows **Unallocated**, right click and select **New Simple Volume**. (Figure 3.5.2.B)

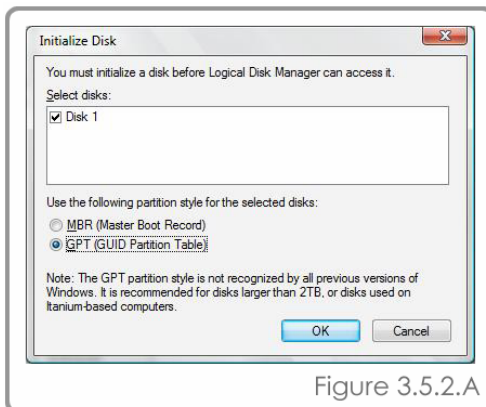

Figure 3.5.2.A

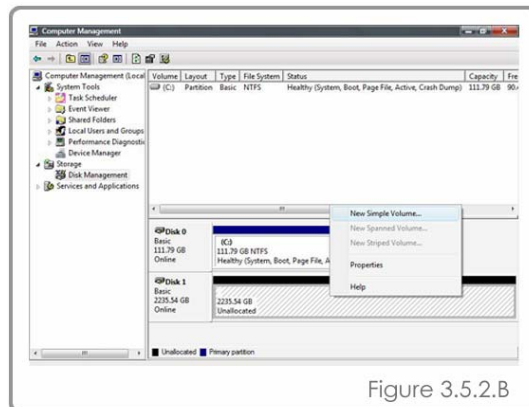

Figure 3.5.2.B

6. The **New Simple Volume Wizard** dialog box will appear, click **Next** to continue.
7. After selecting partition type, specifying partition size and assigning drive letter, the **Format Partition** dialog box will appear, you have the option of selecting the **Quick Format** option. This allow mach fast formatting, however, this disallow Disk Management to check the drive sector for errors. Click Next to start the format process.
8. Your drive should now appear in your **Computer** and ready for use.

4. Management

4.1. LCD displayed Messages

The status of the ACS-77100 can be viewed through the LCD display. By using the scroll buttons to scroll through the messages, the following information is available.

RAID level and capacity	Disk drive model	Disk capacity
Controller firmware version	Controller serial number	Fan and temperature status

4.1.1. Booting Messages

LCD Display	Message
RAID Box Boot	ACS-77100 is booting
RAID Box Initialize Disks	ACS-77100 is initializing the installed disks

4.1.2. Set over 2TB Capacity Messages

LCD Display	Message
Enable over 2T Press ENT select	Press ENT button to set enable/disable over 2TB
Enable over 2T (YES)	Enable over 2TB capacity
Enable over 2T (NO)	Disable over 2TB capacity

4.1.3. Initialization Messages

LCD Display	Message
Create New RAID? No (Yes)	Create a new RAID.
RAID INIT XX.X % Total: XXXX GB	New array being created.
RAID Init 100 % XXXX GB INIT OK!	RAID Initialization completed successfully.

LCD Display	Message
RAID INIT Failed DX offline	Disk X failed during the initialization. The initialization cannot proceed.
RAID INIT Failed DX Bad sectors	Too many bad sectors in Disk X, initialization cannot proceed.

4.1.4. System Ready Messages

LCD Display	Message
RAID Box Ready hh:mm	ACS-77100 is ready for use.

4.1.5. Rebuild Messages

LCD Display	Message
DX Rebuild XX.X% Total: XXX GB	Rebuilding data to a new disk (Disk X) since Disk X failure.
DX Rebuild 100% XXX GB OK!	Disk rebuild completed successfully.
DX Rebuild Fail XX GB < YYY GB	The capacity of the new disk (Disk X) is too small. XXX GB is the capacity of the new disk. YYY GB is the minimum disk capacity of the RAID.
DX Rebuild Fail DX offline	Disk rebuilding fail since Disk X failed.
DX Rebuild Fail DX Bad sectors	Disk rebuilding fail since too many bad sectors in Disk X

4.1.6. Error Messages

RAID Failure Messages

LCD Display	Message
RAID Fail code: 0	The RAID failed since there are not enough disk members.
RAID Fail code: 1 <xxxx>	The RAID failed since the sequence of the disks is incorrect. The current sequence is displayed within the < > space.
RAID Fail code: 2	The RAID has been failed, but all disks exist.

Disk Failure Message

LCD Display	Message
Disk X fail	Disk X failed.

Fan Failure Message

LCD Display	Message
Fan Fail XXXX rpm	Fan failure. The xxxx rpm is the current rpm for the fan.

Overheating Error Message

LCD Display	Message
Temperature!! XX°C > 50°C	System overheating. The XX is the current temperature

4.2. StorConn GUI introduction

ACS-77100 support remote RAID subsystem monitoring by web-based GUI. This section covers the introduction of the monitoring software.

Key Features

- Graphical User Interface (GUI)
- Multi-interface support
- Remote monitoring
- Web-based environment
- Event notification

StorConn monitoring program, a web-based GUI supporting In-band interface via SATA channel and Out-band interface via RS-232, by which customers can monitor the RAID status from web browsers at a remote

site. The StorConn is also capable of sending out notification mail to the customers.

4.2.1. RAID status monitoring window

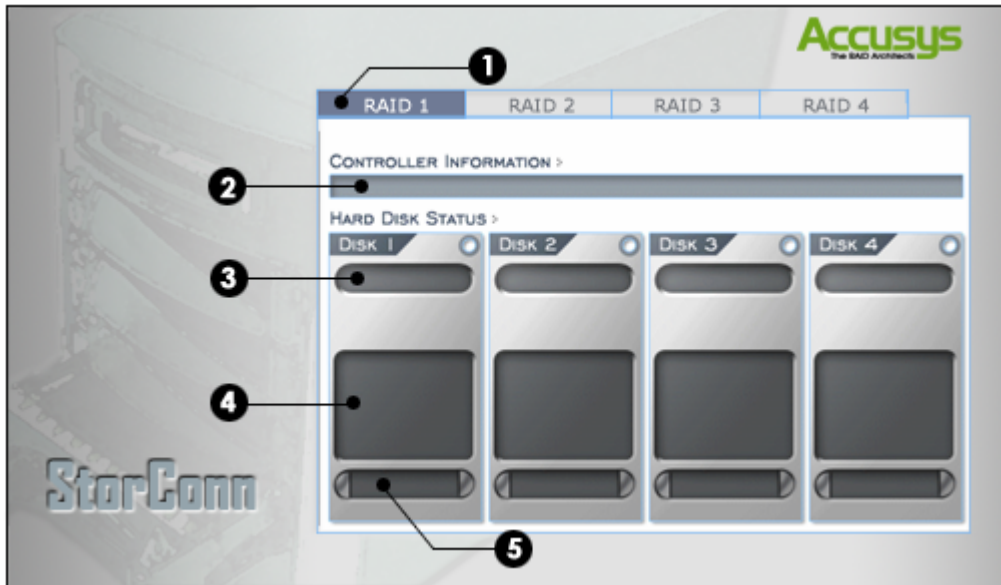

1. **RAID controller tab:** Allow customer to select which RAID to monitor.
2. **Controller information:** Lists model name, serial number and current RAID level.
3. **Disk status:** Allows you to monitor the status of each of the disk drives.
4. **Disk information:** Lists model name and capacity of each of the disk drives.
5. **Re-build / initialize progress:** Tracks the re-building or initialization process.

5. Update Firmware

ACS-77100 allows the customers to update firmware via RS-232 interface. The firmware can be updated from a host PC with third party communication software, such as HyperTerminal, that supports ANSI terminal emulation. The setup process for HyperTerminal will be guided in this chapter.



Note

The data and configurations on the array are not affected by firmware updating.



Note

The HyperTerminal is bundled as standard with Microsoft Windows operating system. It will be found in the Communications folder. The program can also be download from Higrave Software at <http://www.higrave.com/htpr/>

5.1. Firmware updating steps

1. Ensure the ACS-77100 is turned off.
2. Connect one end of the supplied RS-232 cable to the RS-232 3pin port from the Pin2, 4, 6 of the CN8 on the ACS-77100 controller, and connect the other end to one of the host computer's COM port.

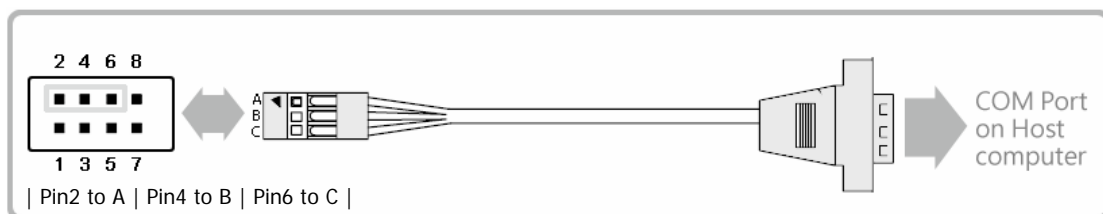

3. Launch HyperTerminal from the host computer: Start > Programs > Accessories > Communications > HyperTerminal.

4. Select COM1 or COM2 from the Connect using: dropdown menu, depending on which port is connector to ACS-77100.

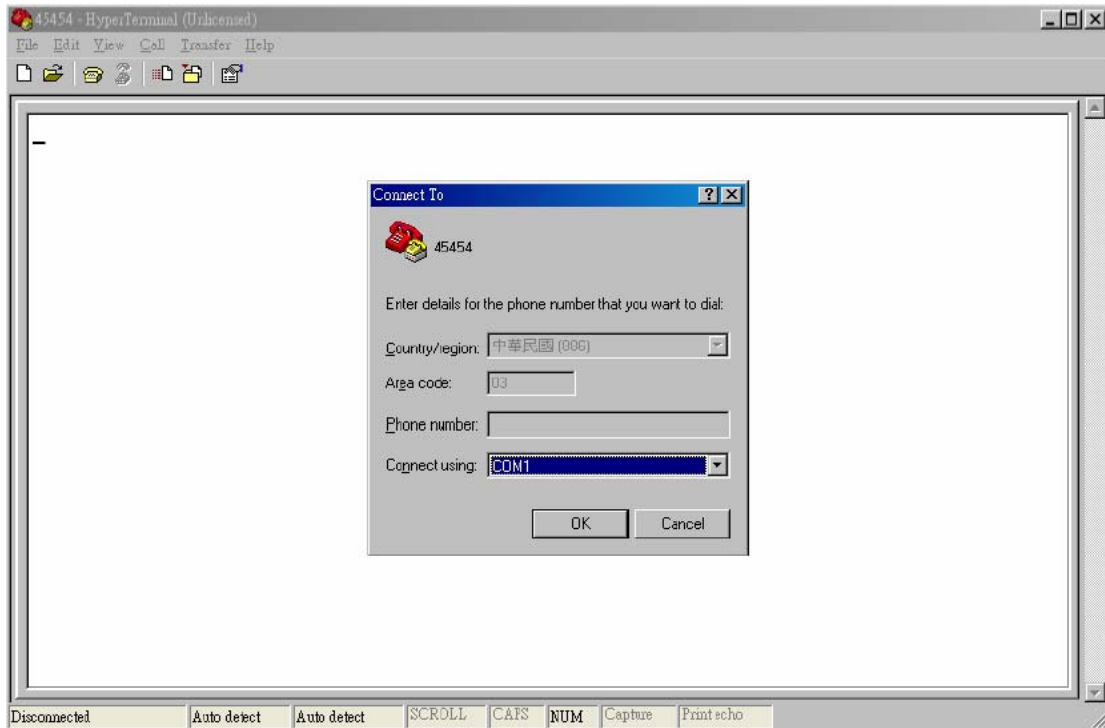

5. The COM properties dialog box will appear. Set the following values:

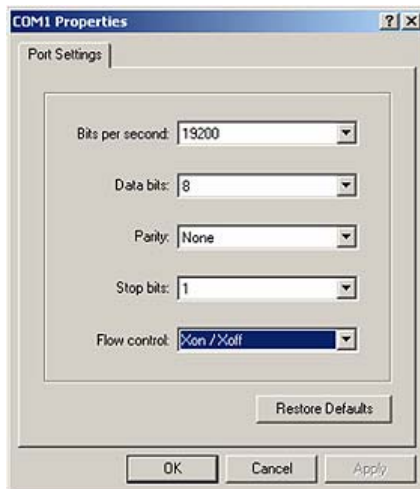

- Bit per second: 19200
- Data bits: 8
- Parity: None
- Stop bits: 1
- Flow Control: Xon/Xoff

6. Turn on the ACS-77100 and press the **ESC** button on the host computer keyboard. The ">>>" prompt will appear.

7. Type in the command "download" to go to the firmware download mode, then type "1" to download code (Firmware or Bootcode).

```
>>> download
restart ... 01 GPIO 01 AAA 01 01
===== 76 Download Mode =====
Enter '1' to Download Code (Firmware, Bootcode)
      'ESC' exit
      'r' reset

----- version: Boot ---- 13 (a) ---- 03 Downloading Code!
Flash type: SST39VF040
```

8. Locate the updates firmware file to send. For HyperTerminal, go to the **Transfer** menu and select **Send Text File**.

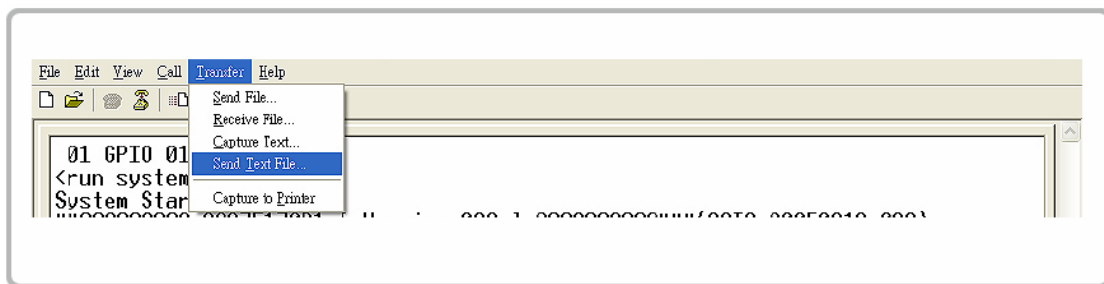

9. Send the firmware file as a text file. The file will start to download.



Caution
Do not turn off the system or interrupt program during firmware-updating procedure.

10. When the file has been downloaded, after ACS-77100 restarted, the firmware-updating procedure is finished.

6. Trouble Shooting

Problem	Possible solution
The ACS-77100 does not appear in the BIOS.	Ensure that the array has completed the initialization process.
How should I react to disk failure?	<p>For a RAID 5/RAID 10 array, you should replace the failed disk. Data rebuilding will then begin.</p> <p>For a RAID 5+hot spare array, data will be rebuilt automatically to the hot-spare disk. There is no need to immediately replace the failed drive.</p> <p>The capacity of new disk you installed must equal or larger than the disks installed in ACS-77100. Otherwise, it will be rejected by ACS-77100, though it has no any damage.</p>
LCD display RAID Fail Code 0.	<p>The status for RAID fail Code 0 is: Not enough number of function disks for a RAID to operate</p> <p>Please create a new array.</p>
LCD display RAID Fail Code 1 <x x x x>	<p>Represents disk sequence is wrong, and the current sequence displayed within < >.</p> <p>Example:</p> <p><2134>: disk 2 and disk 1 sequence is reversed.</p> <p>Please power off the ACS-77100 and replace the disks on the right slot.</p>
LCD display RAID Fail Code 2	<p>The status for RAID Fail Code 2 is: The RAID has been failed, but all disks exist.</p> <p>Please create a new array.</p>

7. FAQ

If you encounter a problem while using the RAID box, check this section for help.

1. I have connected the ACS-77100 to host computer, but the host computer cannot recognize the ACS-77100 in BIOS.

The array of the ACS-77100 must be created so that the host computer can recognize the RAID in BIOS. Please make sure that an array is created.

2. My Operating System is Linux. I have enabled the over 2TB capacity setting, but I still cannot partition a device over 2TB in OS. Why?

The ACS-77100 is over 2TB available, but most OS still cannot support SATA device to over 2TB. Please refer to the below list for choosing the OS.

a) Microsoft Windows Vista

8. Contact Accusys

Accusys, Inc.

- 8F, No. 47, Lane 2, Sec. 2, Guangfu Rd., Hsinchu, Taiwan
- Tel : +886-3-575-0668
- Fax : +886-3-575-0866
- Website: www.accusys.com.tw
- Sales : sales@accusys.com.tw
- Support: support@accusys.com.tw

Accusys U.S.A., Inc.

- 46710 Fremont Blvd. Fremont, CA 94538, U.S.A.
- Tel: +1-510-661-0800
- Fax: +1-510-661-9800
- Toll-free number: +1-866-277-5888
- Website: www.accusysusa.com
- Sales : sales@accusysusa.com
- Support: support@accusysusa.com

Accusys China, Inc.

- 1701, Blk B, Horizon International Tower, No. 6 Zhichun Street, Haidian District, Beijing, postcode 100088, China.
- Tel : +86-10-82800080 /81 /82 /83
- Fax : +86-10-82800784
- Website: www.accusys.com.cn
- Sales: sales@accusys.com.cn
- Support: support@accusys.com.cn

Accusys EU B.V

- Columbusstraat 22-26, Distripark Eemhaven, 3165 AD Rotterdam, Netherlands
- Tel : +31-10-4284117
- Fax : +31-10-4284114
- Website: www.accusyseau.com
- Sales : sales@accusyseau.com
- Support: support@accusyseau.com

Accusys Korea, Inc.

- Baegang B/D 5F Shinsa-Dong 666-14 Kangnam-Gu, Seoul, Korea
- Tel : (02)6245-9050
- Fax : (02)3443-9050
- Website: www.accusys.co.kr
- Email : sales@accusys.co.kr