

# LM2825 Application Information Guide

National Semiconductor  
Application Note 1038  
Luc Van de Perre  
November 1999



## INTRODUCTION

The LM2825 is a complete 1A DC-DC buck converter packaged in a 24-lead molded dual-in-line integrated circuit package.

Contained within the package are all the active and passive components for a high efficiency step-down (buck) switching regulator. Available in fixed output voltages of 3.3V, 5V, 12V and adjustable version, these devices can provide up to 1A of load current with fully guaranteed electrical specifications.

This application note is intended to provide the user of this device with all the information and applications necessary to use the part in its fullest extent.

The following topics are covered:

- Pin functions
- Input capacitor selection
- Output ripple voltage and transients
- Start-up considerations including use of Shutdown/Soft-start feature
- Application circuits
- Thermal considerations and board layout

## PIN FUNCTIONS (see Figure 1)

**Input (pin 16–21)**— This is the positive input supply for the switching regulator. If the main bypass capacitor is more than 6 inches away from the device, a suitable input bypass capacitor must be present at this pin to minimize voltage transients and to supply the switching currents needed by the regulator. See additional information in "Input Capacitor Selection" section.

**Ground (pin 1, 2, 11, 12, 23)**— Circuit ground. See additional information in "Thermal Considerations and Board Layout" section.

**Output (pin 4–8)**— This is the regulated positive output from the switching regulator. See additional information in "Output Ripple Voltage and Transient" and "Thermal Considerations and Board Layout" section.

**Shutdown/Soft-start (pin 13, 14)**— This dual function pin provides the following features: (a) Allows the switching regulator circuit to be shut down using logic level signals thus dropping the total input supply current to approximately 65  $\mu$ A. (b) Adding a capacitor to this pin provides a Soft-start feature which minimizes startup current and provides a controlled ramp up of the output voltage. See additional information in "Start-up Considerations including use of Shutdown/Soft-start feature" section.

**NC (Do not use) (pin 3, 9, 10, 15, 22, 24)**— These pins should remain electrically isolated. Do not connect any signal to these pins. The only reason to connect these pins to the PCB is for reduced thermal resistance. See additional information in "Thermal Considerations and Board Layout" section.

**Special Note:** If the Shutdown/Soft-start feature is not used, the pin should be left open. The internal pull-up current will make sure that the device is ON.

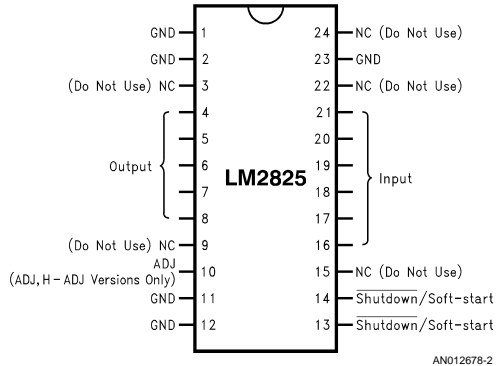

FIGURE 1. Connection Diagram

## INPUT CAPACITOR SELECTION

If the package is more than 6" away from the main filter or bypass capacitor, a low ESR (Equivalent Series Resistance) aluminum or tantalum input capacitor is required between the input pin and ground pin. This input capacitor prevents large voltage transients from appearing at the input, and provides the instantaneous current needed each time the switch turns on.

The important parameters for the input capacitor are the voltage rating and the RMS current rating. Because of the relatively high RMS currents flowing in a buck regulator's input capacitor, this capacitor should be chosen for its RMS current rating rather than its capacitance or voltage ratings, although the capacitance value and voltage rating are directly related to the RMS current rating.

The RMS current rating of a capacitor could be viewed as a capacitor's power rating. The RMS current flowing through the capacitor's internal ESR produces power which causes the internal temperature of the capacitor to rise. The RMS current rating of a capacitor is determined by the amount of current required to raise the internal temperature approximately 10°C above an ambient temperature of 105°C. The ability of the capacitor to dissipate this heat to the surrounding air will determine the amount of current the capacitor can safely sustain. Capacitors that are physically large and have a large surface area will typically have higher RMS current ratings. For a given capacitor value, a higher voltage electrolytic capacitor will be physically larger than a lower voltage capacitor, which will allow it to dissipate more heat to the surrounding air, and therefore will have a higher RMS current rating.

The consequences of operating an electrolytic capacitor above the RMS current rating is a shortened operating life. The higher temperature speeds up the evaporation of the capacitor's electrolyte, resulting in eventual failure.

Selecting an input capacitor requires consulting the manufacturer's data sheet for maximum allowable RMS ripple current. For a maximum ambient temperature of 40°C, a general guideline would be to select a capacitor with a ripple current rating of approximately 50% of the DC load current. For ambient temperatures up to 70°C, a current rating of 75% of the DC load current would be a good choice for a conservative design. If you want a more accurate number for the current rating, you can use the following formulas:

$$I_{CAP\_RMS} = \sqrt{D \cdot (I_{OUT}^2 - D \cdot I_{OUT}^2 + \frac{\Delta I_{LOAD}^2}{12})}$$

$$\Delta I_{LOAD} = \frac{(V_{IN} - V_{SAT})D}{10.2}$$

$$D = \frac{(V_{OUT} - V_D)}{(V_{IN} - V_{SAT}) + (V_{OUT} + V_D)}$$

$$V_D = 0.5V \quad V_{SAT} = 1V$$

The capacitor voltage rating must be at least 1.25 times greater than the maximum input voltage, and often a much higher voltage capacitor is needed to satisfy the RMS current requirements.

The graph shown in *Figure 2* shows the relationship between an electrolytic capacitor value, its voltage rating, and the RMS current it is rated for. These curves were obtained from the Nichicon series of low ESR, high reliability electrolytic capacitors designed for switching regulator applications. Other capacitor manufacturers offer similar types of capacitors.

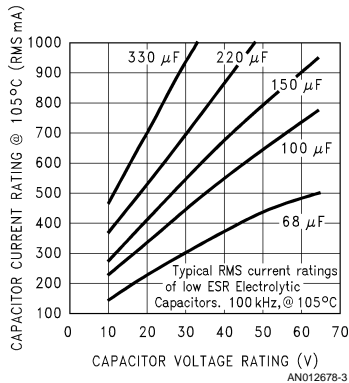

**FIGURE 2. RMS Current Ratings for Low ESR Electrolytic Capacitors (typical)**

Standard electrolytic capacitors typically have much higher ESR values, lower RMS current ratings and typically have a shorter operating lifetime, compared to low ESR electrolytic capacitors.

Surface mount solid tantalum capacitors are often used for input bypassing, because of their small size and excellent performance. However, several precautions must be observed. A small percentage of solid tantalum capacitors can short if the inrush current rating is exceeded. High dV/dt applied at the input can cause excessive charge current through low ESR tantalum capacitors. This high charge current can result in shorting within the capacitor. Several capacitor manufacturers do a 100% surge current testing on their products to minimize this potential problem. If high start-up currents are expected, it may be necessary to limit

this current by adding either some resistance or inductance before the tantalum capacitor, or select a higher voltage capacitor. As with aluminum electrolytic capacitors, the RMS ripple current rating must be sized to the load current.

An aluminum electrolytic capacitor's ESR value is related to the capacitance value and its voltage rating. In most cases, higher voltage electrolytic capacitors have lower ESR values (see *Figure 3*). To provide the low ESR values and the high RMS current ratings, a high voltage capacitor may be needed.

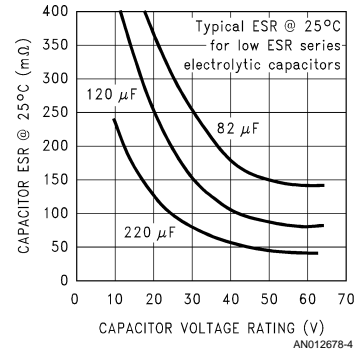

**FIGURE 3. Capacitor ESR vs Capacitor Voltage Rating (Typical Low ESR Electrolytic Capacitor)**

Electrolytic capacitors are not recommended for temperatures below -25°C. The ESR rises dramatically at cold temperatures and typically rises 3X @ -25°C and as much as 10X at -40°C (see *Figure 4*). Fortunately, in an application circuit, the current flowing through the capacitor will warm up the capacitor, so the ESR will decrease somewhat.

Solid tantalum capacitors have a much better ESR for cold temperatures and are recommended for temperatures below -25°C.

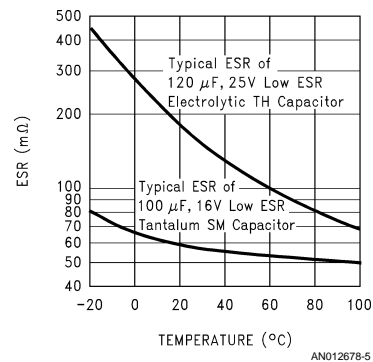

**FIGURE 4. Capacitor ESR Changes vs Temperature**

For a through hole design, an electrolytic capacitor (Panasonic HFQ series or Nichicon PL series or equivalent) would be adequate. Other types or other manufacturers capacitors can be used provided the RMS ripple current ratings are adequate.

For surface mount designs, solid tantalum capacitors can be used, but caution must be exercised with regard to the ca-

capacitor surge current rating. The TPS series available from AVX, and the 593D series from Sprague are both surge current tested.

Use caution when using ceramic capacitors for input bypassing, because it may cause severe ringing at the  $V_{IN}$  pin.

### OUTPUT VOLTAGE RIPPLE AND TRANSIENTS

The output voltage of a switching power supply operating in the continuous mode will contain a sawtooth ripple voltage at the switcher frequency, and may also contain short voltage spikes at the peaks of the sawtooth waveform. The LM2825 switching power supply will operate in continuous mode when the load current is 0.25A or greater.

A typical output ripple voltage can range from approximately 0.5% to 3% of the output voltage. If very low output ripple voltage is needed (less than 15 mV), a post ripple filter is recommended (See *Figures 5, 6*). The inductance required is typically between 2  $\mu$ H and 3  $\mu$ H, with low DC resistance, to maintain good load regulation.

A 47  $\mu$ F capacitor is used to maintain low output impedance and good transient response. A smaller capacitor can be used if the load does not require these characteristics.

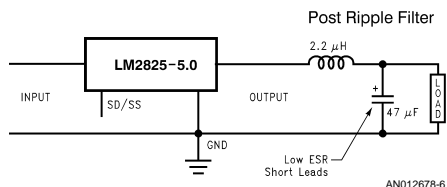

FIGURE 5. Post Ripple Filter

The photo shown in *Figure 6* shows a typical output ripple voltage, with and without a post ripple filter.

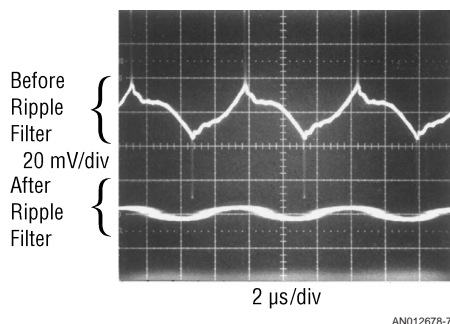

FIGURE 6. Post Ripple Filter Waveform

The voltage spikes are caused by the fast switching action of the switch, the diode, and the parasitic inductance of the output filter capacitor, which are all inside the LM2825. Wiring inductance, stray capacitance, as well as impedance of the scope probe used to evaluate these transients, will contribute to the amplitude of these spikes.

When observing output ripple on an oscilloscope, it is essential that a short, low inductance scope probe ground connection be used (see also "Thermal Considerations and Board Layout" section). Most scope probe manufacturers provide a special probe terminator which is soldered onto the regulator board, preferably at the output capacitor. This provides a

very short scope ground thus eliminating the problems associated with the 3 inch ground lead normally provided with the probe, and provides a much cleaner and more accurate picture of the ripple voltage waveform.

When the device is operating in the continuous mode, the inductor current waveform ranges from a triangular to a sawtooth type of waveform (depending on the input voltage). For a given input and output voltage, the peak-to-peak amplitude of this inductor current waveform remains constant. As the load current increases or decreases, the entire sawtooth current waveform also rises and falls. The average value (or the center) of this current waveform is equal to the DC load current.

If the load current drops to a low enough level, the bottom of the sawtooth current waveform will reach zero, and the switcher will smoothly change from a continuous to a discontinuous mode of operation. The LM2825 will run discontinuous if the output is lightly loaded. This is a perfectly acceptable mode of operation.

### START-UP CONSIDERATIONS, INCLUDING USE OF SHUTDOWN/SOFT-START FEATURE

#### NORMAL START-UP

Under normal operating conditions, the LM2825 can require large input currents during start-up. *Figure 7* shows that the input current reaches a peak of almost 2A with only 250 mA load current. The output voltage comes up in approximately 400  $\mu$ s. Although the input peak current and the output voltage transient can be very high, for most conditions, the device will start-up without problems.

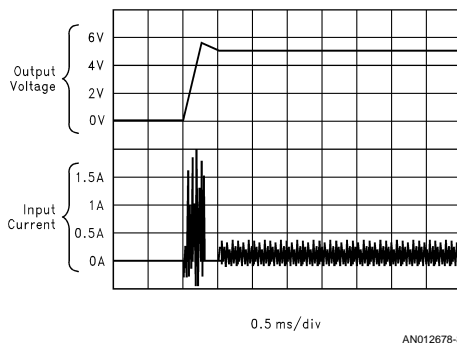

FIGURE 7. Output Voltage and Input Current during Start-Up

However, some power supplies can't deliver these high start-up currents, which may cause the device to have difficulties during start-up.

#### CIRCUMSTANCES THAT MAY CAUSE DIFFICULTY IN START-UP

The LM2825 will have difficulties starting when the voltage applied to the input of the device has a high  $dV/dt$  and is used under the following conditions:

- High input voltage ( $> 20V$ )

and/or

- High temperature ( $T_J > 75^\circ\text{C}$ )

Because of the high start-up currents needed at the input under these conditions, the device goes into second stage current limit (oscillator frequency decreases, output voltage drops) and it can't get out of this state. The start-up current is calculated as follows:

$$dI = ((V_{IN} - V_{OUT})/L) * dt$$

For Example:

$$V_{IN} = 35\text{V}$$

$$V_{OUT} = 5\text{V (desired)}$$

$$I_{OUT} = 1\text{A}$$

$$f_{osc} = 150\text{ kHz} \rightarrow dt = 6.67\ \mu\text{s}$$

$$L = 68\ \mu\text{H}$$

When the device is turned on, the output is 0V, so the duty cycle wants to go to its maximum. The initial current ramp is:

$$dI = ((35\text{V} - 0\text{V}/68\ \mu\text{H}) * 6.67\ \mu\text{s})$$

$$dI = 3.43\text{A}$$

The higher the input voltage the higher the dI. Since the current limit of the LM2825 is 1.4A (typical), the device will go into current limit. Figure 9 shows the inductor current waveform versus time. The device goes into current limit even faster when the inductor saturates. The inductor is designed for a maximum of 1.3A. The higher the temperature, the faster the inductor saturates, as indicated by the dotted line in Figure 9.

During the OFF time, we get the following:

$$dI = ((0.5\text{V} + 0\text{V})/68\ \mu\text{H}) * \text{small } t_{off}$$

As a result: dI = very small

The inductor won't be able to release the stored energy. During the next ON cycle, the current ramps up quickly until it hits current limit again. The device can't get out of this state, unless it is reset.

**IMPROVING START-UP BY USING A SOFT-START CAPACITOR**

Start-up can be improved by using a Soft-start capacitor. Figure 8 shows the range of input voltages, and ambient temperatures, where the Soft-start capacitor ( $C_{SS}$ ) is required. This curve is typical for maximum rated output current loads and can be used as a guideline. As the output current decreases, the operating area requiring a Soft-start capacitor decreases. For temperatures above  $70^\circ\text{C}$ , you typically need a Soft-start capacitor. Capacitor values between  $0.1\ \mu\text{F}$  and  $1\ \mu\text{F}$  are recommended. Tantalum or ceramic capacitors are appropriate for the application.

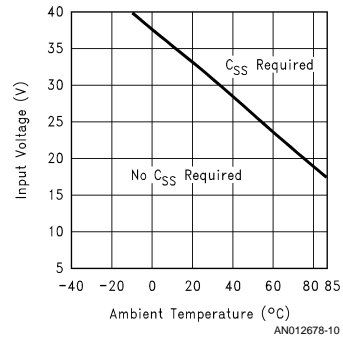

FIGURE 8. Usage of The Soft-Start Capacitor

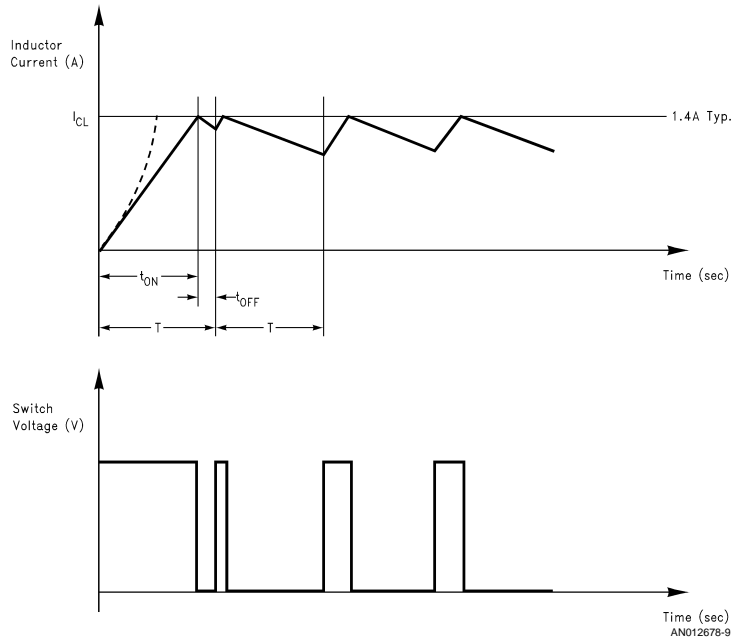

FIGURE 9. Inductor Current and Switch Voltage vs Time, during Current-Limited Start-Up

A capacitor on the  $\overline{SD/SS}$  pin provides the regulator with a Soft-start feature (slow start-up). When the DC input voltage is first applied to the regulator, or when the Shutdown/Soft-start pin is allowed to go high, a constant current (approximately 5  $\mu\text{A}$ ) begins charging this capacitor. As the capacitor voltage rises, the regulator goes through four operating regions (see the bottom curve in Figure 10).

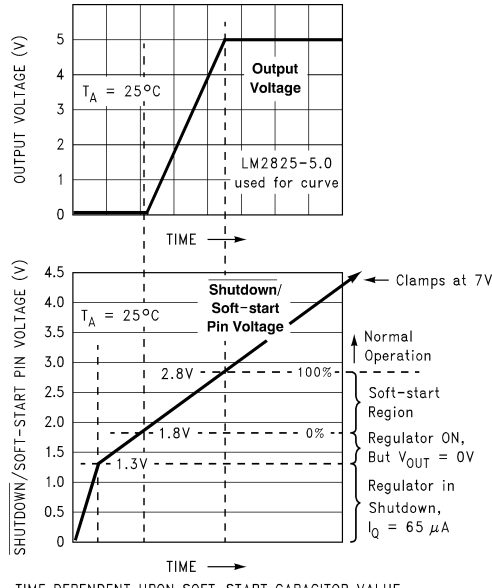

FIGURE 10. Soft-Start and Output Voltage Waveforms

- 1. Regulator in shutdown.** When the  $\overline{SD/SS}$  pin voltage is between 0V and 1.3V, the regulator is in shutdown, the output voltage is zero, and the IC quiescent current is approximately 65  $\mu\text{A}$ .
- 2. Regulator ON, but the output voltage is zero.** With the  $\overline{SD/SS}$  pin voltage between approximately 1.3V and 1.8V, the internal regulator circuitry is operating, the quiescent current rises to approximately 5 mA, but the output voltage is still zero. Also, as the 1.3V threshold is exceeded, the Soft-start capacitor charging current decreases from 5  $\mu\text{A}$  down to approximately 1.6  $\mu\text{A}$ . This decreases the slope of capacitor voltage ramp.
- 3. Soft-start Region.** When the  $\overline{SD/SS}$  pin voltage is between 1.8V and 2.8V (@ 25°C), the regulator is in a Soft-start condition. The output (pin 4–8) duty cycle initially starts out very low, with narrow pulses and gradually get wider as the capacitor  $\overline{SD/SS}$  pin ramps up towards 2.8V. As the duty cycle increases, the output voltage also increases at a controlled ramp up. See the top curve in Figure 10. The input supply current requirement also starts out at a low level for the narrow pulses and ramp up in a controlled manner. This is a very useful feature in some switcher topologies that require large startup currents which can load down the input power supply.  
Note that the lower curve shown in Figure 10 shows the Soft-start region from 0% to 100%. This is not the duty cycle percentage, but the output voltage percentage. Also, the Soft-start voltage range has a negative temperature coefficient associated with it.
- 4. Normal operation.** Above 2.8V, the circuit operates as a standard Pulse Width Modulated switching regulator. The capacitor will continue to charge up until it reaches the internal clamp voltage of approximately 7V.

The circuit of Figure 11 shows the LM2825 with the Shutdown/Soft-start feature, using different logic signals to shutdown the device, while allowing the use of Soft-start. When the regulator is shutdown, the quiescent current is typically reduced to 65  $\mu\text{A}$ .

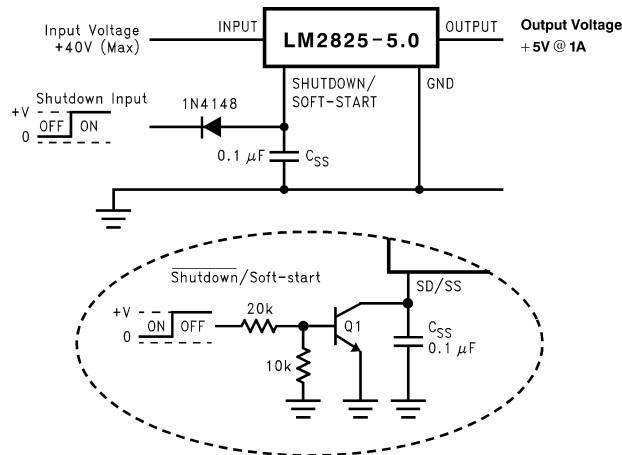
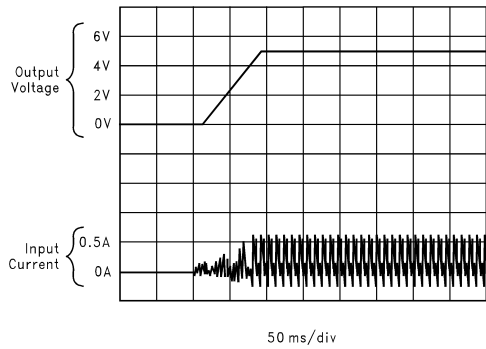
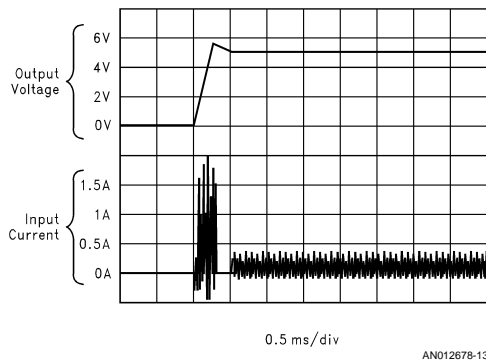

FIGURE 11. Typical Circuits Using Shutdown/Soft-Start Features

The plots in *Figures 12, 13* show the effect of Soft-start on the output voltage and the input current, with and without a Soft-start capacitor. The reduced input current required at startup is very evident when comparing the two plots. The Soft-start feature reduces the startup current from almost 2A down to several hundred mA ( $V_{IN} = 10V$ ,  $V_{OUT} = 5V$  and  $I_{load} = 250\text{ mA}$ ,  $C_{SS} = 0.1\text{ }\mu\text{F}$ ), and delays and slows down the output voltage rise time.



**FIGURE 12. Output Voltage and Input Current at Start-Up, with Soft-Start**



**FIGURE 13. Output Voltage and Input Current at Start-Up, without Soft-Start**

This reduction in start-up current is useful in situations where the input power source is limited in the amount of current it can deliver.

If a very slow output voltage ramp is desired, a larger Soft-start capacitor can be used. Many seconds or even minutes are possible. The Start-up time can be estimated to be:

$$\Delta t = (C_{SS}) (2 \times 10^6) \text{ sec}$$

This is the time between applying the input voltage and the output reaching its nominal voltage.

If this pin is driven from a voltage source, the current must be limited to about 1 mA.

#### UNDERVOLTAGE LOCKOUT

Some applications require that the regulator remains OFF until the input voltage reaches a predetermined voltage. An example of an undervoltage lockout is shown in *Figure 14*. The zener diode establishes the threshold voltage when the device begins operating. When the input voltage is less than the zener voltage, resistors R1 and R2 hold the Shutdown/Soft-start pin low, keeping the device in the shutdown mode. As the input voltage exceeds the zener voltage, the zener conducts, pulling the Shutdown/Soft-start pin high, allowing the LM2825 to begin switching. The threshold voltage for the undervoltage lockout feature is approximately 1.5V greater than the zener voltage.

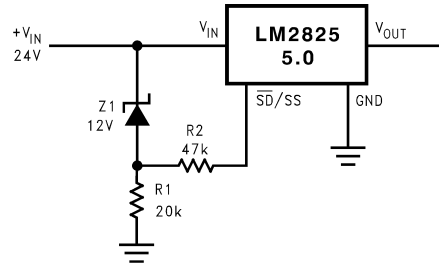

**FIGURE 14. Undervoltage Lockout Circuit**

This solution is cheap and simple, but at the same time, the precision is low. If you want a high precision undervoltage lockout circuit, *Figure 15* gives you a better solution.

For a predetermined input voltage, resistor R1 can be calculated with the following equation:

$$R1 = \frac{5.1 \left[ 1 - \left( \frac{1.225}{V_{IN}} - \frac{R_3}{R_3 + R_4 + R_5} \right) \right]}{\left( \frac{1.225}{V_{IN}} - \frac{R_3}{R_3 + R_4 + R_5} \right)}$$

The schematic and equation will provide a hysteretic undervoltage lockout circuit design. The hysteresis band is approximately 10 mV.

Once the circuit has been incorporated with the complete power supply and powered circuitry, the values of R1, R2, R3, R4, and R5 can be optimized.



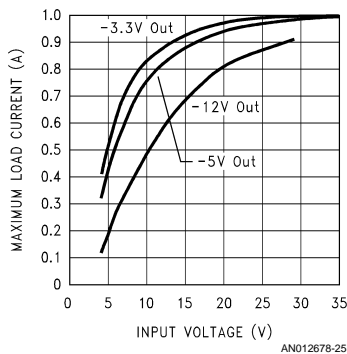

FIGURE 17. Inverting Regulator Typical Load Current

This type of inverting regulator can require relatively large amounts of input current when starting up, even with light loads. Input currents as high as the LM2825 current limit (approx 1.4A) are needed for at least 2 ms or more, until the output reaches its nominal output voltage. The actual time depends on the output voltage. Input power sources that are current limited or sources that can not deliver these currents without getting loaded down, may not work correctly. Because of the relatively high startup currents required by the inverting topology, the Soft-start feature shown in Figure 16 is recommended.

Also shown in Figure 16 are several shutdown methods for the inverting configuration. With the inverting configuration, some level shifting is required, because the ground pin of the regulator is no longer at ground, but is now at the negative output voltage. The shutdown methods shown accept ground referenced shutdown signals.

Figures 18, 19 apply the undervoltage lockout feature to an inverting circuit. Figure 18 features a constant threshold voltage for turn ON and turn OFF (zener voltage plus approximately one volt). Since the  $\overline{SD/SS}$  pin has an internal 7V zener clamp, R2 is needed to limit the current into this pin to approximately 1 mA when Q1 is on. If hysteresis is needed, the circuit in Figure 19 has a turn ON voltage which is different than the turn OFF voltage. The amount of hysteresis is approximately equal to the value of the output voltage.

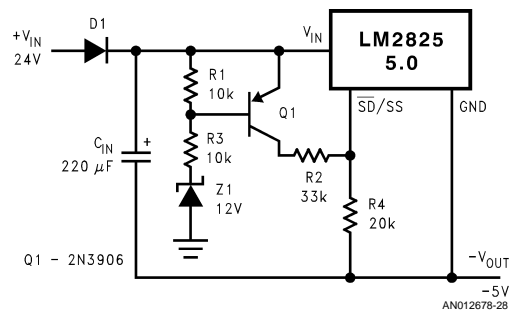

FIGURE 18. Undervoltage Lockout Without Hysteresis for an Inverting Regulator

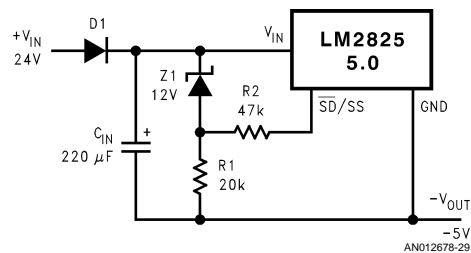

FIGURE 19. Undervoltage Lockout With Hysteresis for an Inverting Regulator

#### THERMAL CONSIDERATIONS AND BOARD LAYOUT

For best thermal performance, wide copper traces (several mm's) should be used. Pins should be soldered to generous amounts of printed circuit board copper (except for the No Connect (NC) pins). Large areas of copper provide the best transfer of heat (lower thermal resistance) to the surrounding air, and even double sided or multilayer boards provide a better heat path to the surrounding air. Unless power levels are small, sockets are not recommended because of the increased thermal resistance and the resultant higher junction temperatures.

Figure 20 shows  $\theta_{JA}$  for different PCB areas and two different output power levels.



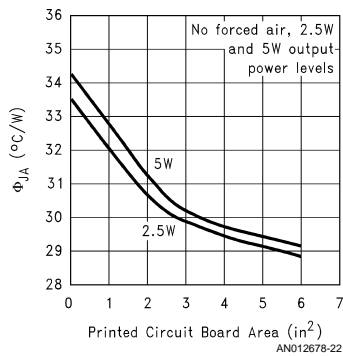

**FIGURE 20.  $\theta_{JA}$  vs Board Area for 2 Output Power Levels**

Figure 21 shows the effect of forced air on  $\theta_{JA}$ . The higher the windspeeds, the less influence the board area has.

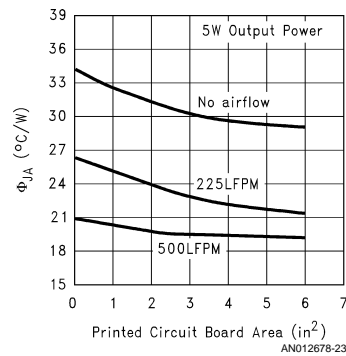

**FIGURE 21.  $\theta_{JA}$  vs Board Area for 3 Windspeed Levels**

Package thermal resistance numbers are all approximate, and there are many factors that will affect the junction temperature. Some of these factors include board size, shape, thickness, position, location, and even board temperature. Other factors are, trace width, printed circuit copper area, copper thickness, single- or double-sided, multilayer board, and the amount of solder on the board.

For best ripple performance, use pin 23 as the input GND and pin 11 and 12 as the output GND for minimum spikes at the output. If you can, avoid using pins 1, 2 and 23 as output GND pins. Figure 22 shows the PCB layout which gives you the smallest spikes at the output voltage.

When you measure the output ripple voltage with a scopeprobe (see also "Output Ripple Voltage and Transients" section), it makes a difference where you connect the ground of the probe. Photo a) in Figure 23, shows the output voltage ripple when the ground is connected to pin 1, 2 or/and 23. Photo b) shows the same thing when the ground is connected to pin 11 and 12. So, for a better ac performance, it is better to connect the ground of your power supply to pin 23 and the ground of your system electronics to pin 11 and 12.

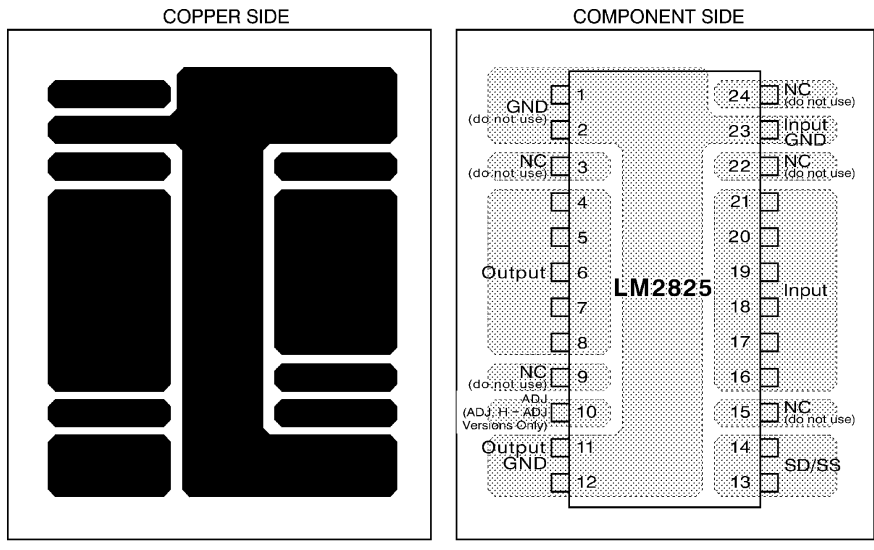

FIGURE 22. PCB Layout for Better Ripple and Spikes Performance (2 x Size)

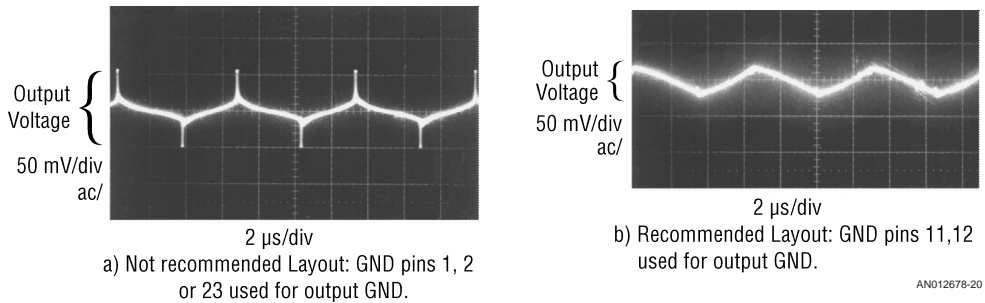

FIGURE 23. Ripple and Spikes at the Output Voltage

**LIFE SUPPORT POLICY**

NATIONAL'S PRODUCTS ARE NOT AUTHORIZED FOR USE AS CRITICAL COMPONENTS IN LIFE SUPPORT DEVICES OR SYSTEMS WITHOUT THE EXPRESS WRITTEN APPROVAL OF THE PRESIDENT AND GENERAL COUNSEL OF NATIONAL SEMICONDUCTOR CORPORATION. As used herein:

1. Life support devices or systems are devices or systems which, (a) are intended for surgical implant into the body, or (b) support or sustain life, and whose failure to perform when properly used in accordance with instructions for use provided in the labeling, can be reasonably expected to result in a significant injury to the user.
2. A critical component is any component of a life support device or system whose failure to perform can be reasonably expected to cause the failure of the life support device or system, or to affect its safety or effectiveness.

**National Semiconductor Corporation**  
Americas  
Tel: 1-800-272-9959  
Fax: 1-800-737-7018  
Email: support@nsc.com  
[www.national.com](http://www.national.com)

**National Semiconductor Europe**  
Fax: +49 (0) 1 80-530 85 86  
Email: europe.support@nsc.com  
Deutsch Tel: +49 (0) 1 80-530 85 85  
English Tel: +49 (0) 1 80-532 78 32  
Français Tel: +49 (0) 1 80-532 93 58  
Italiano Tel: +49 (0) 1 80-534 16 80

**National Semiconductor Asia Pacific Customer Response Group**  
Tel: 65-2544466  
Fax: 65-2504466  
Email: sea.support@nsc.com

**National Semiconductor Japan Ltd.**  
Tel: 81-3-5639-7560  
Fax: 81-3-5639-7507