

## RC Terminator Networks 700 Series

**BOURNS®**

### General Description

This series of RC Networks is designed to eliminate transmission line effects, such as signal reflections and ringing which influence high speed CMOS. The Networks capacitor blocks DC currents while acting as a short circuit during signal transmissions, thus reducing power consumption. The capacitor also holds the bus at the last logic level to avoid excessive currents.

### Block Diagram Of CPU/BUS Configuration

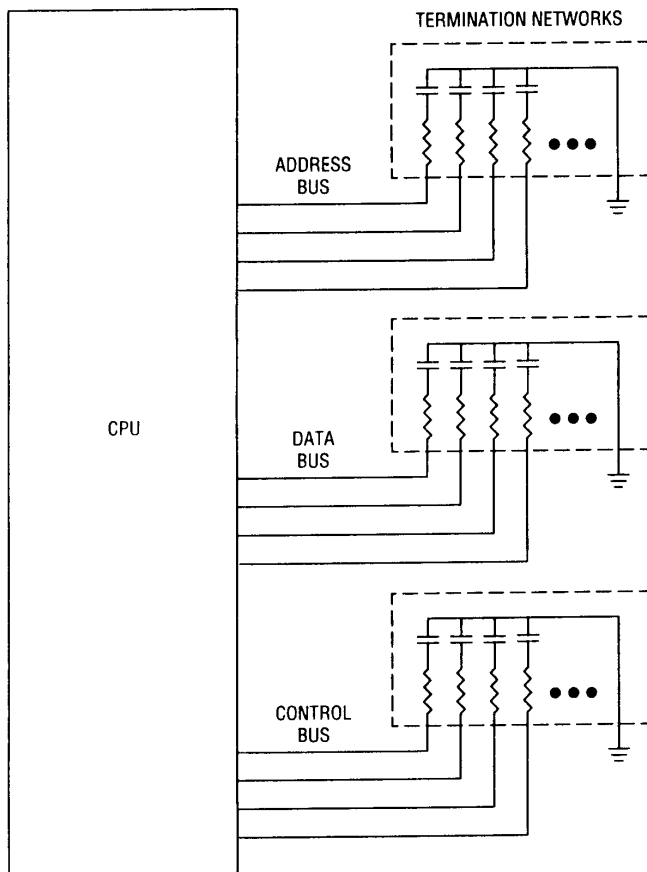

### Bus Termination Applications Of Bourns Networks

At high frequencies, the traces on a printed circuit board act as transmission lines—in which impedance mismatches can cause distortion of signals on that line. Terminating the lines with resistor or resistor-capacitor networks provides the means to match impedances and reduce signal distortion.

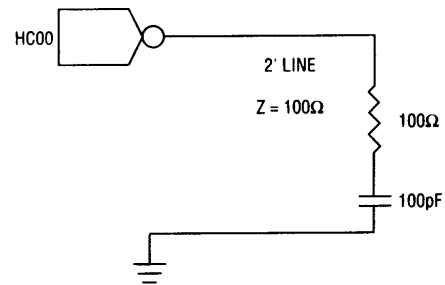
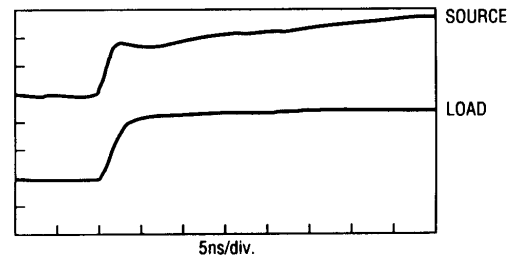

Bus termination (in this case, RC termination technique) considerably reduces overshoots and ringings.

Transmission lines require termination when the time it takes the signal to travel from one end of the line to the other (the propagation delay) amounts to 1/2 or more of the edge rate of the signal (signal rise time or fall time). In other words, termination is required when:

$$T_{pd} > (1/2)T_e \quad \begin{matrix} T_e = \text{edge rate} \\ T_{pd} = \text{propagation delay} \end{matrix}$$

Present high-speed logic families have typical rise times of 2 nanoseconds, while the propagation delay of a common PCB is about 1.77 ns per foot. Applying the above relationship, a transmission line will require termination if it is longer than 7 inches.

High performance systems will commonly need Bourns termination networks for CPU address, data, and control lines. In addition, clock inputs, write and read strobe lines, chip select or output enable lines of high speed devices such as static RAMs, PROMs, and PLDs will also need termination networks.

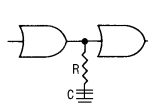
TERMINATION TECHNIQUE	TYPICAL POWER USAGE	ADDS DELAY	RESISTOR VALUE	CAPACITOR VALUE
RC 	MEDIUM	NO	$Z_0$	200-500pF

## RC Terminator Networks 700 Series

**BOURNS®**

For designers developing high performance systems, exact termination resistances which account for line loading may be desirable. This resistance (or equivalent resistance) can be calculated using the formula:

$$R_{\text{term}} = \frac{Z_0}{\sqrt{1 + C_d / C_0}}$$

where  $Z_0$  is the characteristic impedance of the line,  $C_d$  is the total capacitance associated with the receiving devices (typically 5 pF per input gate) or other loads off the line, and  $C_0$  is the intrinsic capacitance of the line.

The series termination technique suppresses reflections at the driving device should any waveforms be reflected back from the driven end of the line. Series termination preserves power since there is no current path to ground or  $V_{cc}$  as in the other methods. However, this technique results in incident signals that transition slowly. It is also not appropriate for distributed loads due to the half-amplitude waveforms which exist at intermediate points along the line.

RC termination represents a compromise between power consumption and effect on performance. Its principle of operation is similar to parallel termination, but the capacitor blocks the DC component of the signal, thus reducing power consumption. However, the effectiveness of this method depends on the frequency and duty cycle of the application. RC termination also can be an expensive technique if implemented using discrete components rather than a network.

### Typical Usage

While not every address, data and control line may require pull-up/pull-down or termination as part of the system's design, the table below shows common practice for some popular devices.

	MICROPROCESSORS				MICRO-CONTROLLERS	
	68000	68020	80286	80386	68HC11	8051
No. address lines	23	32	24	32		
Termination	0	32	0	32		
No. data lines	16	32	16	32		
Termination	0	32	0	32		
No. control lines	21	27	13	15		
Termination	0	27	0	15		
Total I/O lines	60	91	53	79	38	32
Termination	0	91	0	79	0	0

**701**

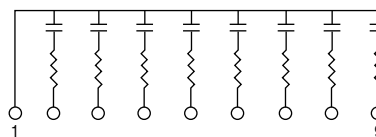
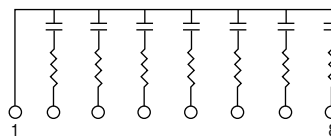

NO. OF LINES	BOURNS P/N	PACKAGE
7	4608H-701-RC/CC	High Profile Conformal SIP
8	4609H-701-RC/CC	
9	4610H-701-RC/CC	

**702**

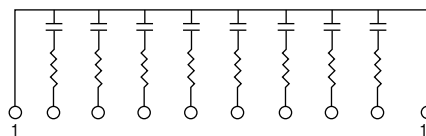

NO. OF LINES	BOURNS P/N	PACKAGE
8	4610H-702-RC/CC	High Profile Conformal SIP

For all RC terminators, standard  $R$  values are 50, 68, 75 and 100 ohms. Standard values for  $C$  are 47, 100, 500 and 1000pF. See data sheet to select custom combinations of  $R$  and  $C$ .

### REFERENCES:

1. Blood, W.R., MECL System Design Handbook, Motorola, Inc., 1983.
2. F100K ECL Data Book, Fairchild Semiconductor Corp., 1986.
3. MECL Device Data, Motorola, Inc., 1987.