

OPERATOR'S INSTRUCTION MANUAL

MSU IV MASS STORAGE UNIT

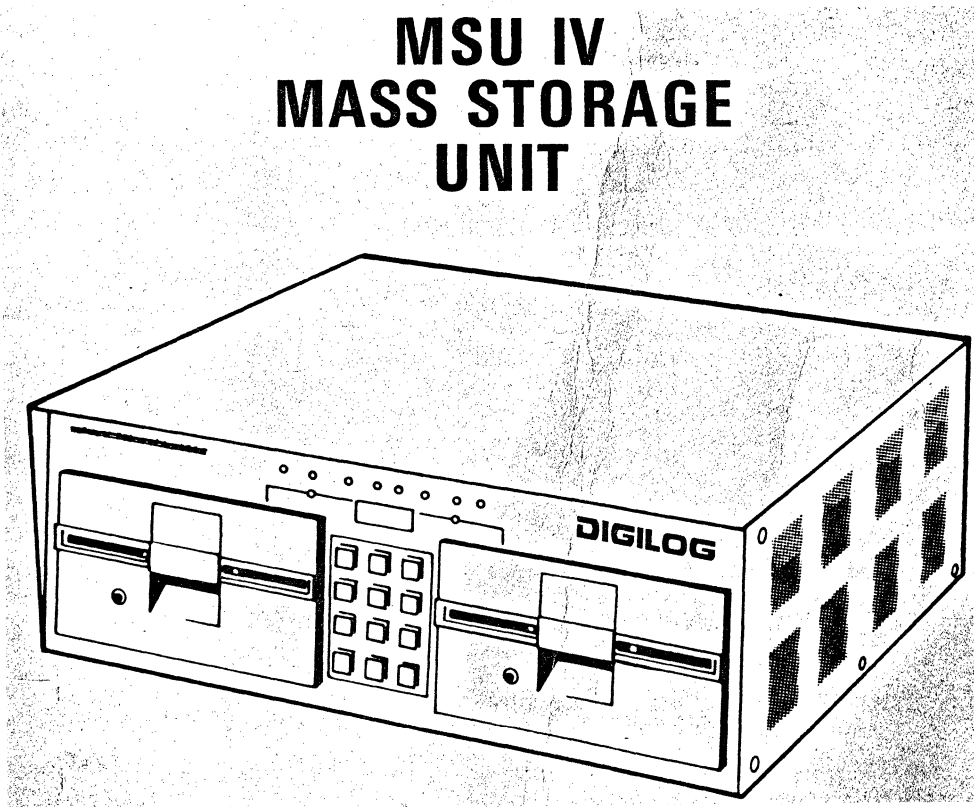

DIGILOG
NETWORK CONTROL DIVISION
1370 WELSH ROAD, MONTGOMERYVILLE, PA 18836
(215) 628-4530 TWX 510-661-0060

OPERATOR'S MANUAL

MSU IV

MASS STORAGE UNIT

DIGILOG, INC.
NETWORK CONTROL DIVISION
1370 WELSH ROAD
MONTGOMERYVILLE, PA 18936

(215) 628-4530 TWX 510-661-0060

This document contains information that is proprietary to DIGILOG, Inc. Reproduction or distribution without prior written approval is prohibited. All rights reserved. This publication is subject to change without notice.

First Edition: August, 1982

P/N 98-7004-00 Rev A

MSU IV OPERATOR'S MANUAL
PREFACE TO FIRST EDITION

The first edition of MSU IV's Operator's Manual provides the information necessary to operate DIGILOG's MSU IV mass storage unit. It is intended to be used with the manual supplied with a DIGILOG DLM data line monitor, as well as with the manuals that are supplied with other communication system equipment.

Chapter 1 of this manual contains a general description of MSU IV along with a listing of its characteristics and specifications.

Chapter 2 contains descriptions of the unit's controls, switches, indicators, and connectors.

Chapter 3 provides the information necessary to connect and operate the unit in conjunction with a DLM, or a standalone RS-232 communication line.

Every attempt has been made to include the latest and most accurate information in this manual's first edition. Users are requested to submit any suggestions or corrections that they believe should be included in the manual's next edition. Suggestions for changes should be directed to:

Manager of Documentation
DIGILOG, Inc.
1370 Welsh Road
Montgomeryville, PA 18936

MSU IV OPERATOR'S MANUAL
TABLE OF CONTENTS

CHAPTER 1

DESCRIPTION OF EQUIPMENT

Paragraph	Page
1.1 Introduction	1-1
1.2 General Description	1-1
1.3 Specifications and Characteristics	1-2

CHAPTER 2

CONTROLS, INDICATORS, AND CONNECTORS

2.1 Introduction	2-1
2.2 Operating Voltage Selection and Fuse Replacement	2-1
2.3 Applying Power	2-2
2.4 Front Panel Disk Drives, Control Keys, and Indicators	2-3
2.4.1 Disk Drive Units	2-4
2.4.2 Control Keys	2-5
RUN and HALT Keys	2-8
DISK INITL Key	2-8
DRIVE SEL Key	2-10
READ WRITE Key	2-10
STOP/CONT Key	2-10
EVENT MARK Key	2-11
OPER SEL Key	2-11
TRACK FWD Key	2-12
TRACK BACK Key	2-13
SPEED SEL Key	2-13
RS-232 DLM Key	2-14
2.4.3 Indicators	2-14
TRACK/STATUS Indicator	2-14
Disk Drive Activity Indicators	2-18
DRIVE 1 and DRIVE 2 Indicators	2-18
COPY 1 TO 2 Indicator	2-18
DISK INITL Indicator	2-18
ON-STOP/OFF-CONT Indicator	2-19
READ DISK Indicator	2-19
WRITE DISK Indicator	2-19
READ TRACK Indicator	2-19
FIND EVENT Indicator	2-19
ON-RS232/OFF-DLM Indicator	2-20
2.5 REAR Panel Connectors	2-20

IBM IV OPERATOR'S MANUAL

TABLE OF CONTENTS

(Continued)

CHAPTER 3

OPERATION

	Page
3.1 Introduction	3-1
3.2 Interface Connections and Self-Test	3-1
3.3 RS-232 Interface Connections	3-2
3.4 Disk Initialization and Organization	3-3
3.5 Recording Data	3-4
3.5.1 Manual (Attended) Data Recording	3-4
3.5.2 Automatic (Unattended) Data Recording	3-6
3.5.3 View Data Before Recording	3-7
3.5.4 View Data After Recording	3-8
3.5.5 Standalone (RS-232) Recording	3-8
3.6 Playing Back Data	3-9
3.6.1 Read Track Operations	3-10
3.6.2 Find Event Operations	3-10
3.6.3 Track Forward/Back Operations	3-11
3.7 Copying Disks	3-12
3.8 Operation with One Drive Inactive	3-13

MSU IV OPERATOR'S MANUAL
TABLE OF CONTENTS

ILLUSTRATIONS

Figure	Page
1-1 Digilog MSU IV Mass Storage Unit	1-1
2-1 Rear Panel Controls and Connectors	2-1
2-2 Front Panel Controls and Indicators	2-4
2-3 Inserting and Removing Diskettes	2-6
2-4 Proper Diskette Care	2-7
3-1 MSU IV and DLM Cable Connections	3-1
3-2 RS-232 Mode Connections	3-2
3-3 View Data Before Recording	3-7
3-4 View Data After Recording	3-8
3-5 Standalone (RS-232) Recording	3-8

TABLES

Table	Page
1-1 MSU IV Specifications and Characteristics	1-2
2-1 Error Messages	2-3
2-2 Front Panel Control Keys	2-9
2-3 Front Panel Indicators	2-15
2-4 Status Messages	2-16
2-5 Speed Selection	2-17
2-6 Rear Panel Connector Pin Designations	2-20

CHAPTER 1

DESCRIPTION OF EQUIPMENT

1.1 INTRODUCTION

This chapter serves as an introduction to the DIGILOG MASS STORAGE UNIT IV (MSU IV). This chapter also includes a general description of the MSU IV along with the list of its characteristics and specifications.

1.2 GENERAL DESCRIPTION

The DIGILOG MSU IV (Figure 1-1) is a compact, low cost mass storage unit for use with a DIGILOG data line monitor (DLM) or with any vendor's data line monitor. The MSU IV can be used by relatively unskilled personnel and serves as an extension of the DLM internal memory. The MSU IV can also be connected to any RS-232 communication device (modem, terminal, FEP, etc.) for direct digital recording of data and status information.

MSU IV uses trouble-free, nonvolatile diskettes to provide unattended data line monitor and the subsequent analysis of long data/control sequences (over 400k bytes). Recording or playback is accomplished in either the standalone RS-232 or the DLM mode. When operated automatically at speeds up to 19.2 kbps on FDX lines, the MSU IV will determine the speed of the line from the data stream. Recording speeds over 19.2 kbps, and up to 72 kbps, can be selected manually by the user.

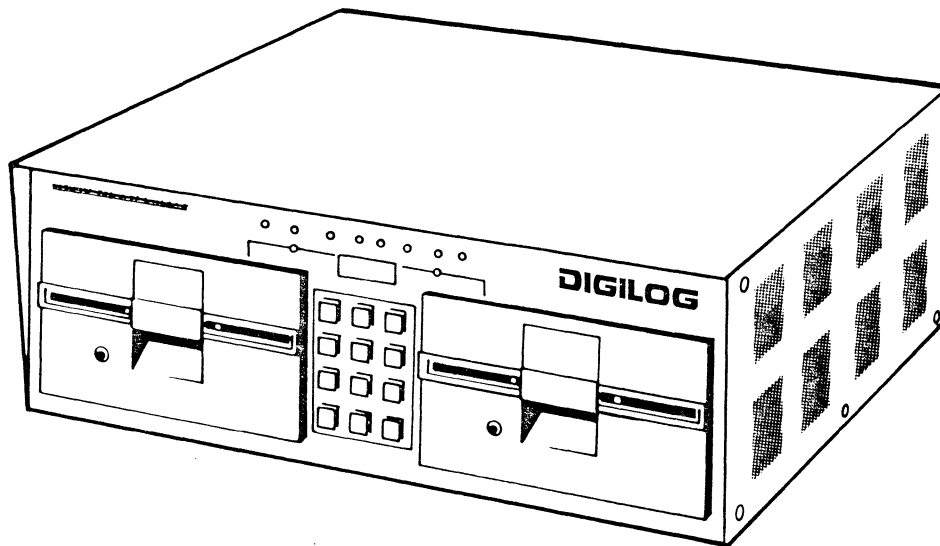

Figure 1-1. DIGILOG MSU IV MASS STORAGE UNIT

MSU IV OPERATOR'S MANUAL
DESCRIPTION OF EQUIPMENT

MSU IV features, such as fault isolation, search, suppression, or playback, can be used to analyze data stored on MSU IV diskettes. Another feature allows direct data and status loading from DIGILOG's line of data monitoring equipment or from an RS-232 data line. Dual diskettes provide added versatility: diskette copy capability, back-up, and true continuous recording.

Diskettes recorded on-site may be analyzed at another location by more experienced personnel. MSU IV can also be used for the recording of communication sequences for use as a data communications training aid.

MSU IV functions automatically under DLM control or may be operated manually as a standalone unit by using front panel controls and indicators.

The MSU IV is supplied in a self-contained carrying case or may be rack mounted.

1.3 SPECIFICATIONS AND CHARACTERISTICS

Table 1-1 contains a listing of MSU IV's specifications and characteristics. The table includes information for both operation and power capabilities.

TABLE 1-1. MSU IV SPECIFICATIONS
AND CHARACTERISTICS

DISK STORAGE:	409,600 data characters, 409,600 status bytes
DATA RATE:	Recording automatically determined from data stream (on FDX lines at 19.2 kbps or lower) or set manually from the front panel (above 19.2 kbps to 72 kbps).
RECORD CONTROL:	Manual or automatic
RECORDING MEDIA:	5-1/4 inch, dual-sided double density diskettes
DRIVES:	48 TPI, double-sided
TRACK/STATUS DISPLAY:	3-digit, 7-segment
LED INDICATORS:	10
KEY SWITCHES:	12
POWER:	115/220 Volts, 50/60 Hz
DIMENSIONS:	Height; 5-3/16 in. (13.5 cm) Width; 15-1/4 in. (39.0 cm) Depth; 16 in. (40.5 cm)
MOUNTING:	19-in. rack mounting (optional)
WEIGHT:	22 lb (10.0 kg) with carrying cover
INTERFACE:	1 DIGILOG DLM interface. Direct recording from an RS-232 line through 2 common connectors (DTE and DCE), 1 playback output connector.

CHAPTER 2

CONTROLS, INDICATORS, AND CONNECTORS

2.1 INTRODUCTION

This chapter describes how to select MSU IV operating voltage, how to change the unit's fuse, and how to apply power. Included are descriptions of the unit's controls, indicators, and connectors. Descriptions of status messages are also included.

2.2 OPERATING VOLTAGE SELECTION AND FUSE REPLACEMENT

MSU IV is normally shipped from the factory ready to operate using a primary source voltage of 115 VAC, 60 Hz; however, it is designed to operate on either 115 or 220 VAC at 50 or 60 Hz. Use the following procedure to check or change the unit's operating voltage configuration. Use Figure 2-1 to locate items referred to in the procedure:

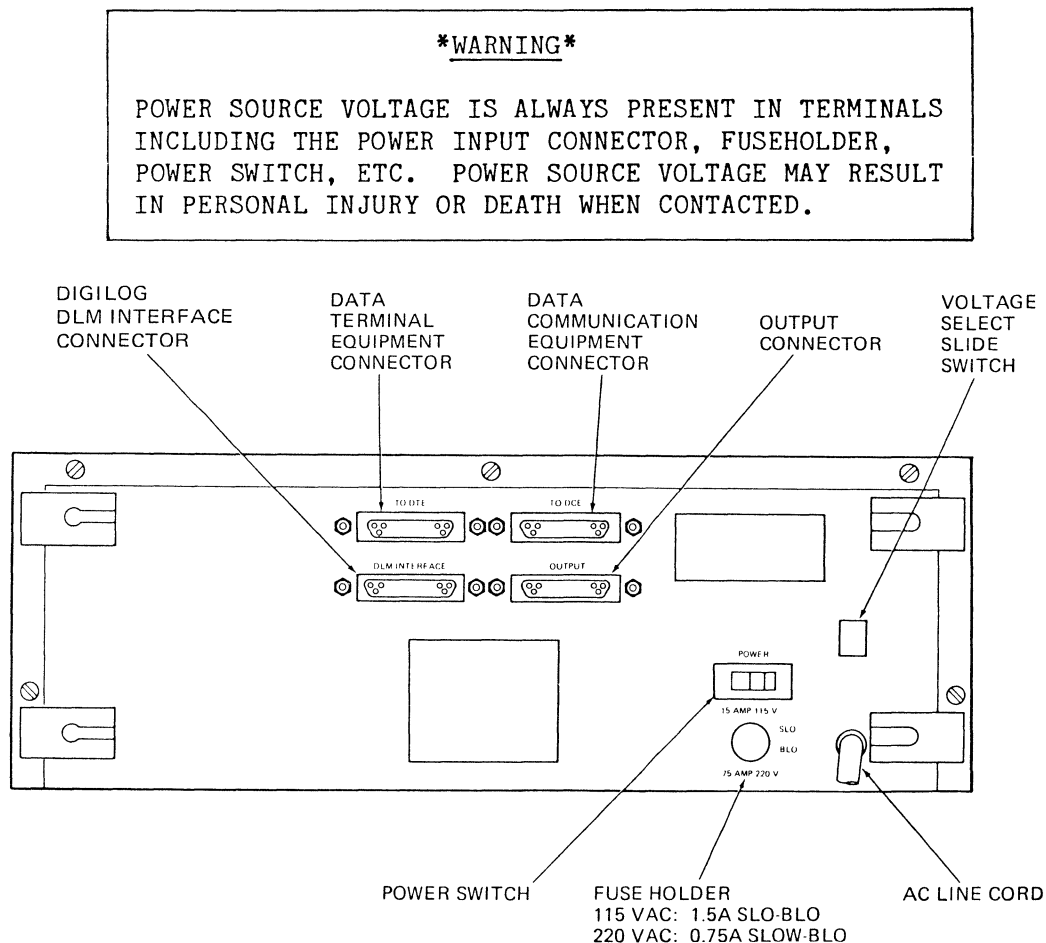

FIGURE 2-1. REAR PANEL CONTROLS AND CONNECTORS

MSU IV OPERATOR'S MANUAL
CONTROLS, INDICATORS, AND CONNECTORS

1. Check that MSU IV's line cord is not plugged into an outlet.
2. Check the setting of the rear panel voltage select slide switch. The number seen, either 115 or 220, must be in the range of the voltage applied to MSU IV.
3. Set the voltage select switch by moving the slide to one extreme position or the other. If MSU IV is being configured to operate in a range of 95V to 130V, set the switch to 115. If the unit is to operate at voltages between 190V and 260V, set the switch to 220.
4. Check the rating of the fuse in the fuseholder. If the unit is configured to operate at 115 VAC, 50 to 60 Hz, the fuseholder must contain a 1.5 A slo-blo fuse. If it is configured to operate at 220 VAC, 50 or 60 Hz, then it must contain a 0.75 A slo-blo fuse.
5. Change the fuse by pushing the fuseholder cap in and twisting it clockwise to loosen. Replace the fuse with a fuse of the same value. Slide the fuse back into the fuseholder cap. Push the fuseholder cap into the fuseholder assembly and twist counterclockwise to seat it in place.

2.3 APPLYING POWER

Before plugging the line cord into an outlet, refer to paragraph 2.2 and verify that MSU IV is configured to operate using the voltage supplied by the outlet. Check that the rear panel POWER switch is set to OFF before plugging the line cord into the outlet.

Apply power to MSU IV by setting the POWER switch to ON. MSU IV automatically performs both a test of its light-emitting diode (LED) indicators (except for the disk drive activity indicators) and an internal diagnostic self-test each time the unit is turned on.

Immediately after the POWER switch is set to ON, verify that MSU IV's front panel indicators light and that the TRACK/STATUS indicator displays 888. A LED failure may cause an incorrect indication during system testing, but this does not mean that the unit cannot be used; however, it does mean that the indicator should be repaired as soon as possible.

Upon completion of the indicator test, DRIVE 1, CONT, and TRACK/STATUS indicators remain lit (the TRACK/STATUS indicator displays 00) and all other indicators go out.

If the unit should fail the internal self-test, the TRACK/STATUS indicator displays the letter E and a two-digit error message. Refer to Table 2-1 for a description of diagnostic error messages. During self-test, MSU IV also performs a test of its own random-access memory (RAM) and erasable programmable read only memory (EPROM). If a RAM or EPROM problem is detected, an error message is displayed on the TRACK/STATUS indicator; refer to Table 2-1.

MSU IV OPERATOR'S MANUAL
CONTROLS, INDICATORS, AND CONNECTORS

Error messages do not prevent MSU IV from being used. It is up to the user to decide if a unit displaying an error message is suitable for use. Since a RAM error (S07) or a EPROM error (S08) can result in defective data, it is recommended that an MSU IV displaying this characteristic not be used.

TABLE 2-1. ERROR MESSAGES

DESCRIPTION	MEANING	CORRECTIVE ACTION
E01	Faulty disk-to-memory data transfer.	Have MSU IV serviced.
E02	CRC error on diskette.	Replace diskette.
E03	E01 and E02.	Have MSU IV serviced.
E04	I.D. not found on diskette.	Initialize diskette. If it has been initialized, replace it.
E05	E01 and E04.	Replace diskette; if error repeats have MSU IV serviced.
E06	E02 and E04.	Replace diskette.
E07	E01 and E02 and E04.	Replace diskette; if error repeats have MSU IV serviced.
E08	MSU IV mode plus diskette type match.	Select proper mode or use proper diskette.
S07	RAM error during diagnostics.	Have MSU IV serviced.
S08	EPROM error during diagnostics.	Have MSU IV serviced.

2.4 FRONT PANEL DISK DRIVES, CONTROL KEYS, AND INDICATORS

The following paragraphs contain functional descriptions of MSU IV's front panel disk drives, control keys, and indicators. Figure 2-2 illustrates MSU IV's front panel.

MSU IV OPERATOR'S MANUAL
CONTROLS, INDICATORS, AND CONNECTORS

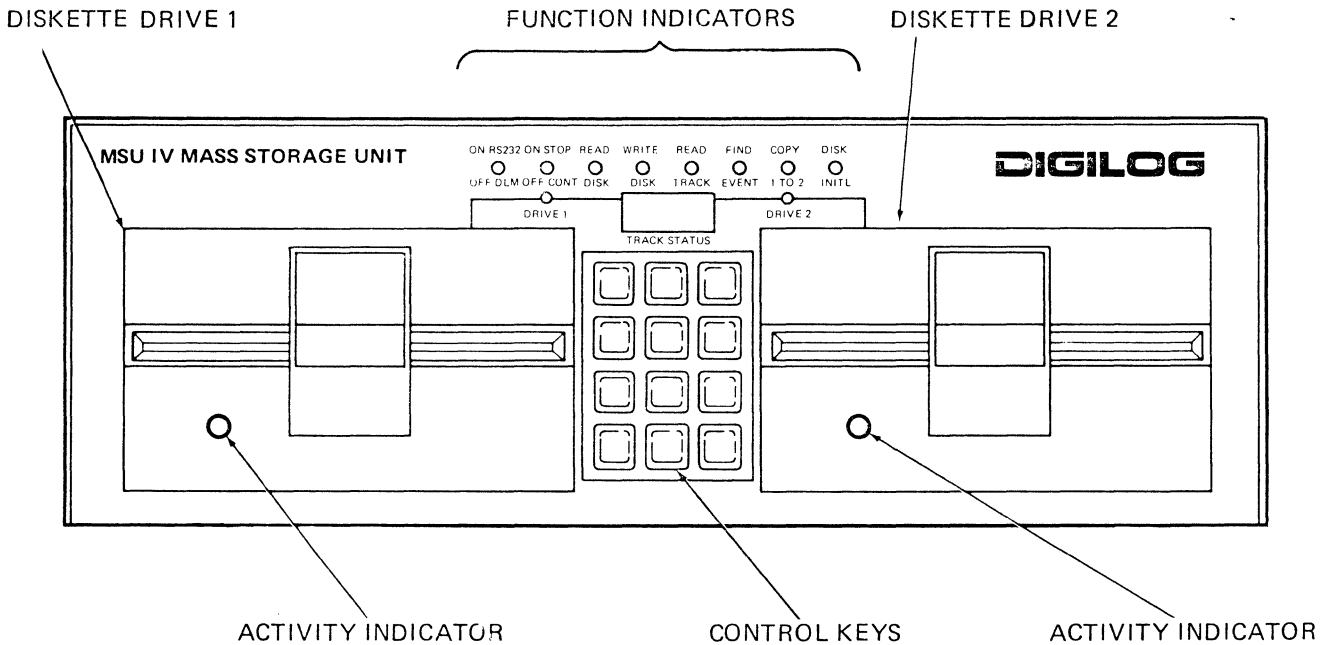

FIGURE 2-2. FRONT PANEL CONTROLS AND INDICATORS

2.4.1 Disk Drive Units

CAUTION

DO NOT TRANSPORT MSU IV WITH DRIVE LATCHES CLOSED, OR WITH MEDIA IN THE DRIVES. THIS CAN RESULT IN DAMAGE TO THE DISK DRIVE UNITS.

Two disk drive units are provided, one on each side of the key panel. This paragraph explains how to insert a diskette into a drive and provides information on the care and handling of diskettes.

To open a disk drive, carefully pull and lift the drive latch to the open position; see Figure 2-3. Hold the diskette so that the tab (or notch) is to the left. Insert the diskette into the open drive and ensure that it is firmly seated. Carefully close the latch; the latch is properly closed when a click is heard.

MSU IV OPERATOR'S MANUAL
CONTROLS, INDICATORS, AND CONNECTORS

CAUTION

NEVER OPEN A DISK DRIVE UNIT WHILE THE ACTIVITY LIGHT IS ON. THIS WILL CAUSE DATA TO BE LOST, AND COULD CAUSE DAMAGE TO THE DISKETTE.

The tab shown in Figure 2-3 covers the write protect notch. If the tab is attached, the diskette can only be read from, not written to. Any attempt to write to a protected diskette (tab present) will result in an S05 status message and no subsequent operation. To write to a protected diskette, first carefully remove the tab.

Each disk drive has an activity indicator. When lit (red), the activity indicator shows that read, write, or seek operations are taking place in that drive. Do not remove diskettes while activity indicator is lit.

In addition to the activity indicators, MSU IV contains DRIVE 1 and DRIVE 2 selection indicators (paragraph 2.4.3.3) plus READ and WRITE selection indicators (paragraph 2.4.3.7) to inform the operator of each disk drive's status. All MSU IV indicators, however, relate to disk drive functions and activity; refer to paragraph 2.4.3 for complete information.

Diskettes can be easily damaged if mistreated. There are certain precautionary measures that must be taken to preserve diskette reliability; refer to Figure 2-4 for proper diskette care.

2.4.2 Control Keys

Twelve control keys are used to set up and operate MSU IV. As shown in Figure 2-2, the keys are grouped together on the MSU IV's front panel. Table 2-2 contains a listing of the keys along with a brief description of each key's function.

In the following paragraphs, each control key is discussed as to its relationship to various indicators as well as to its relationship to MSU IV operating modes.

MSU IV OPERATOR'S MANUAL
CONTROLS, INDICATORS, AND CONNECTORS

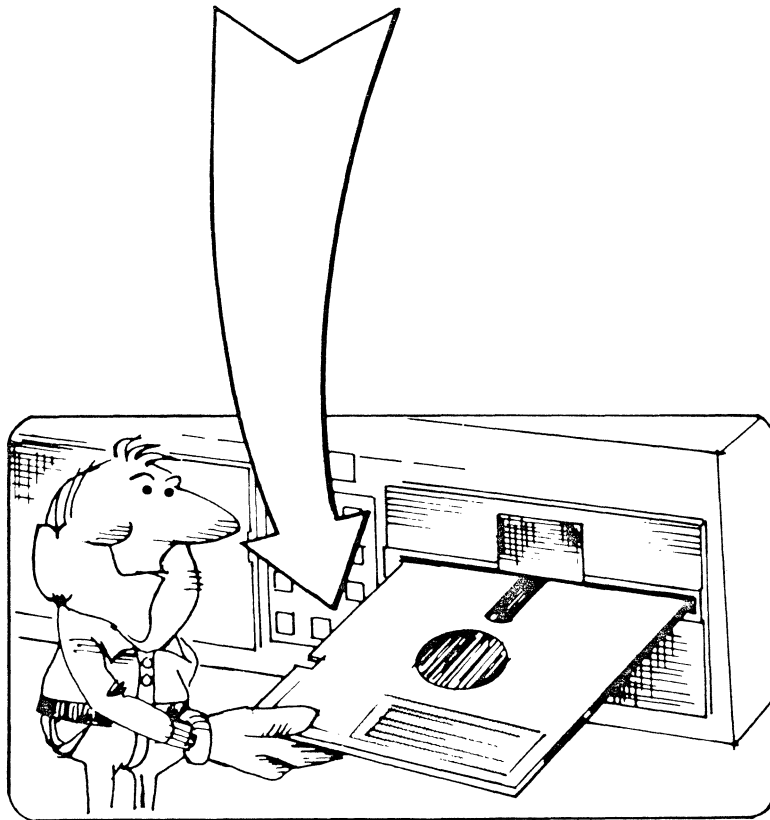
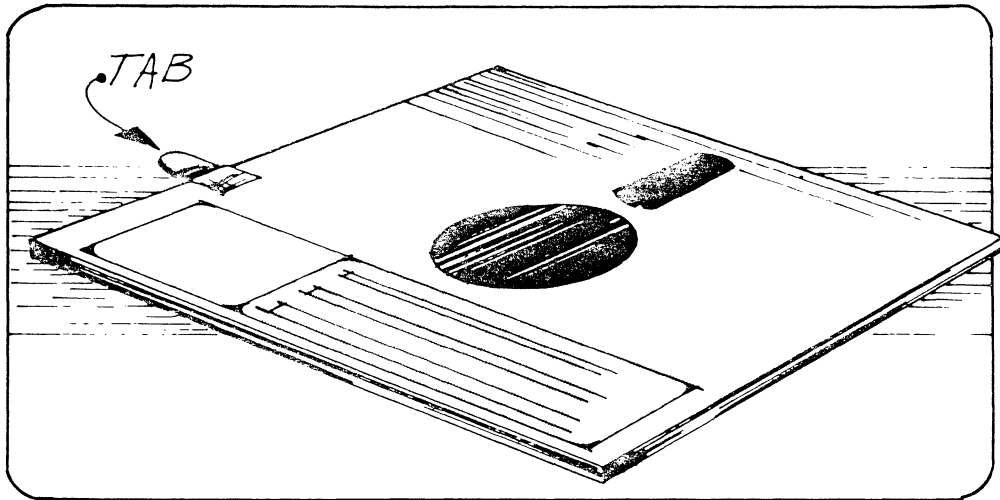
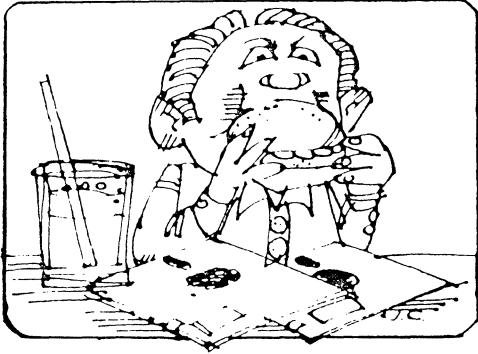

FIGURE 2-3. INSERTING AND REMOVING DISKETTES

MSU IV OPERATOR'S MANUAL
CONTROLS, INDICATORS, AND CONNECTORS



PROTECT THE DISKETTE. Restrict eating, drinking and smoking to other areas. Keep the diskette free of dust.

DO NOT EXPOSE TO ANY MAGNETIC FIELDS. Data can be lost if the diskette is exposed to electric or magnetic fields or stored in a low humidity environment where static electricity is easily generated. Keep the humidity at a reasonable level.

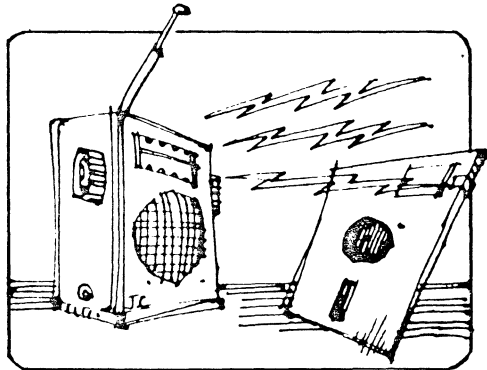

HANDLE GENTLY. Do not touch the diskette's magnetic surface. Never clip, staple, or otherwise damage the cardboard cover. When labeling, use labels supplied by the manufacturer and write on them with a soft felt-tip pen. Do not remove the disk from a drive when the indicator light is on.

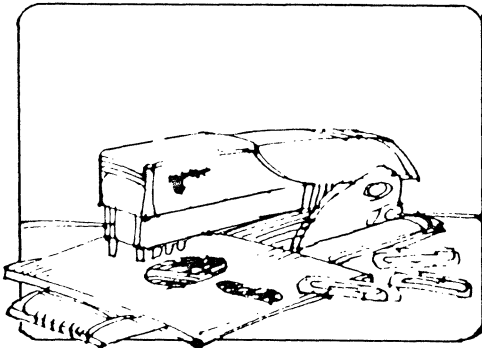

STORE IN A SAFE PLACE. Temperatures in the storage area are to be kept between 10°C – 50°C (50°F – 120°F). Do not expose to direct sunlight and avoid areas where condensation may occur. Always store diskettes in their jackets, labeled, and in an appropriate storage medium; i.e., a diskette box or binder.

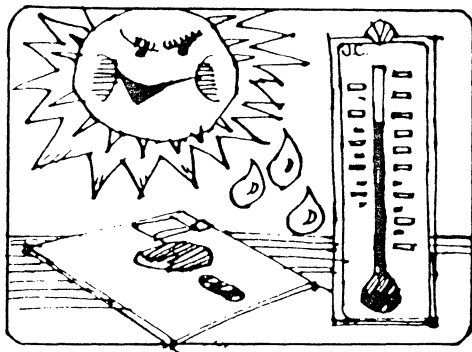

FIGURE 2-4. PROPER DISKETTE CARE

MSU IV OPERATOR'S MANUAL
CONTROLS, INDICATORS, AND CONNECTORS

2.4.2.1 RUN and HALT Keys

Keys RUN and HALT control transferring operation from standby to operate, and back to standby; refer to Table 2-2. These keys are active in the RS-232 and DLM operating modes. When an operating mode is selected using a key, the appropriate LED from the list below begins to blink:

- | | |
|-----------------|----------------|
| 1. COPY 1 TO 2* | 4. WRITE/DISK |
| 2. DISK INITL* | 5. READ TRACK* |
| 3. READ/DISK | 6. FIND EVENT* |

This is a standby or idle condition. When the RUN key is pressed, the blinking LED lights steadily and the associated operation begins.

Depressing the HALT key while any of the above operations are on stops the operation at the end of that I/O cycle and then causes the LED to return to the blinking condition.

If MSU IV is performing a write operation, pressing HALT key, in addition to stopping the unit, places an end of data mark (S02) at that track location. The event mark is used by MSU IV to identify the end of recorded data.

When READ TRACK indicator is lighted steadily, each pressing of the RUN key causes a block (track) of data to be read.

When FIND EVENT indicator is blinking, pressing RUN key causes MSU IV to search for event markers. Upon detection of an event mark, the unit displays status message S01, S02, or S03, and the FIND EVENT indicator returns to blinking. MSU IV is now prepared to read data from the beginning of the track containing the event mark.

When used with a DLM the MSU IV stops reading data when the DLM detects a pre-programmed trap or error condition; the reading sequence, however, need not be interrupted. No characters are lost during a read if a halt occurs at the DLM. Assuming that a continuous read operation is desired, when the DLM is started again after the halt, characters sent to the DLM are contiguous and there are no gaps in the data.

2.4.2.2 DISK INITL Key

The DISK INITL key introduces a mode of operation that causes a diskette inserted in a drive to be formatted (initialized) for use in MSU IV; refer to Table 2-2.

*A second pressing of this key, performed while the key's associated indicator is blinking, turns off the selected mode and related indicator.

MSU IV OPERATOR'S MANUAL
CONTROLS, INDICATORS, AND CONNECTORS

TABLE 2-2. FRONT PANEL CONTROL KEYS

KEY LEGEND	FUNCTIONAL DESCRIPTION
RUN	Starts operation of selected mode as indicated by a lighted indicator.
HALT	Stops operation of mode indicated by lighted indicator. Returns mode indicator to blinking.
DISK INITL	Selects disk initialization mode for blank diskette in selected drive; DISK INITL indicator blinks. Run key starts initialization; DISK INITL indicator lights steadily.
DRIVE SEL	Alternate pressings select either drive 1 or drive 2. DRIVE 1 or DRIVE 2 indicators light to indicate selected unit.
READ WRITE	Alternate pressings select either read or write modes of operation for selected drive; READ or WRITE indicators (as appropriate) blink. RUN key starts the selected operation; READ or WRITE indicator lights steadily. Depressing READ WRITE key overrides other selected (blinking indicator) modes.
STOP CONT	Alternate pressings select either continuous operation, wherein data recording is alternated between drives (CONT indicator lit); or stop-full recording, wherein MSU IV stops recording when enabled diskette is full (ON-STOP indicator lit).
EVENT MARK	Pressing key marks track near data sequence of interest as it is written to diskette. This event mark can be searched for during playback. EVENT MARK key is active only in write mode.
OPER SEL	Selects search mode of operation; read track, find events, or copy 1 to 2. The selected mode indicator starts blinking.
DRIVE SEL	Alternate pressings select either drive 1 or drive 2. DRIVE SEL key is active in all modes.
TRACK FWD	Sequential pressings of this key increment the track number. Holding key pressed for longer than one second causes track number to increment at about 10 per second. Track number is shown on TRACK/STATUS indicator.
TRACK BACK	Same as TRACK FWD key, except that track number decrements.
RS-232	Alternate pressings select either the RS-232 standalone recording mode or the DLM recording mode. The ON-RS232 indicator is lit when the RS-232 mode is selected.

MSU IV OPERATOR'S MANUAL
CONTROLS, INDICATORS, AND CONNECTORS

After a diskette is inserted into the selected drive (paragraph 2.4.2) and DISK INITL key is pressed, the DISK INITL indicator begins blinking and any other previously blinking LEDs go out. Pressing RUN key starts the initialization process and the DISK INITL indicator lights steadily.

When the initialization process terminates, the DISK INITL indicator returns to blinking; the initialized diskette may now be removed from the drive.

2.4.2.3 DRIVE SEL Key

The DRIVE SEL key is active whenever any of the indicators are blinking (standby); refer to Table 2-2. Sequentially pressing the DRIVE SEL key under this condition alternately selects drive 1 (DRIVE 1 indicator lit) or drive 2 (DRIVE 2 indicator lit). Refer to paragraph 2.4.1 for a discussion of the disk drives.

2.4.2.4 READ WRITE Key

Sequential pressings of the READ WRITE key alternately introduce the data read mode (READ indicator blinking) or the data write mode (WRITE indicator blinking). Any other indicators that are blinking go out.

To activate the read or write modes, press the RUN key. A steadily lighted READ or WRITE indicator means that the operation is in progress; refer to Table 2-2.

When indicator READ is blinking, MSU IV is ready to send data from its disks to the DLM capture buffer for display and/or analysis on the DLM screen; refer to paragraph 3-5. When indicator WRITE is blinking, MSU IV is ready to begin receiving data.

2.4.2.5 STOP/CONT Key

Sequential pressings of the STOP/CONT key alternately selects either a continuous recording mode (OFF-CONT indicator not lit) or a stop-full mode (ON-STOP indicator lit); refer to Table 2-2.

In the continuous recording mode, drives 1 and 2 alternate operation as the diskette in each becomes full. DRIVE 1 or DRIVE 2 indicators light to indicate the drive in operation. The operator may either remove a full diskette and replace it with an initialized blank one, or allow data on a full diskette to be written over in subsequent write cycles. If the diskettes aren't removed, data already recorded are replaced by the new data, and the old data are lost; refer to paragraph 2.4.2.

In the stop-full (fixed length) mode, the write operation stops when both diskettes are full or the other drive is not in the ready state (door open, no diskette in drive); the WRITE DISK indicator then begins to blink. The

MSU IV OPERATOR'S MANUAL
CONTROLS, INDICATORS, AND CONNECTORS

operator may either replace the diskettes with initialized blank ones or continue to use the diskettes already in the drives as described for continuous recording above.

The continuous recording mode can be used with only one drive. Select the drive to be used (refer to paragraph 2.4.2.3), and then select either the continuous or stop-full operating mode. Replace the diskette or continue recording when the WRITE DISK indicator begins to blink.

2.4.2.6 EVENT MARK Key

The EVENT MARK key is active only during the write mode (WRITE DISK indicator lit); refer to Table 2-2.

Pressing the EVENT MARK key places an event mark (S01) near a sequence of data characters recorded on the diskette; that is, the key is used to mark a track of interest. Multiple tracks may be marked. During playback, the diskette can be returned to a marked track by using the OPER SEL key.

2.4.2.7 OPER SEL Key

Sequential pressings of the OPER SEL key selects either the READ TRACK, FIND EVENT, or the COPY 1 TO 2 mode of operation. The indicator for the selected mode will start blinking.

Pressing the OPER SEL key until the READ TRACK indicator starts blinking introduces a one-track read mode. Any other blinking indicators go out; refer to Table 2-2.

To read the track of data shown on the TRACK/STATUS indicator, press RUN key. A steadily lighted READ TRACK indicator means that the track is being read, and MSU IV sends (reads) as many as 2,500 characters to the DLM capture buffer; refer to paragraph 2.4.2.4.

After the track is read, the drive stops and READ TRACK indicator begins blinking. READ TRACK can be used with OPER SEL key to read marked data; refer to paragraph 2.4.2.7.

The FIND EVENT mode is active only during the read mode (READ DISK indicator lit); refer to Table 2-2.

NOTE

MSU IV SEARCHES FOR EVENT MARKS S01 AND S02 WHEN PERFORMING FIND EVENT OPERATIONS.

MSU IV OPERATOR'S MANUAL
CONTROLS, INDICATORS, AND CONNECTORS

To locate event marks on a diskette of recorded data, place MSU IV in the read mode and then press OPER SEL key sequentially so that indicator FIND EVENT starts blinking. Next, press RUN key to start the find event operation; indicator FIND EVENT lights steadily, and TRACK/STATUS indicator begins incrementing. The diskette is now being searched in the direction of increasing track number for an event marker, and four things can happen:

1. The TRACK/STATUS indicator cycles continuously, and gives no indication of ever stopping. This can be caused by the absence of event marks on the diskette; press HALT key to exit FIND EVENT mode.
2. The TRACK/STATUS indicator displays message S01, and indicator FIND EVENT starts blinking. This situation means that a track of data containing an event mark inserted by EVENT MARK key was found.

In order to search for the next event mark return to the FIND EVENT mode after performing one of the following actions; either do a READ DISK or READ TRACK operation, or use TRACK FWD key to increment the TRACK/STATUS indicator by one.

3. The TRACK/STATUS indicator displays message S02, and indicator FIND EVENT starts blinking. This situation means that an end of recorded data mark has been found. Press RUN key to search for the next event marker, or press READ key to begin reading data.
4. The TRACK/STATUS indicator displays message S03, and indicator FIND EVENT starts blinking. This situation means that both an event mark and an end of recorded data mark have been found on the same track; proceed as described in 1 and/or 2 above.

Pressing OPER SEL key for the COPY 1 TO 2 mode causes the diskette duplication mode to be introduced (COPY 1 TO 2 indicator starts blinking); refer to paragraph 2-2.

Data on a diskette loaded into drive 1 will be written to a formatted diskette loaded into drive 2 when RUN key is pressed (COPY 1 TO 2 indicator lights steadily). When the copying operation is complete, COPY 1 TO 2 indicator returns to blinking condition; refer to paragraph 2.4.1.

A copy may be started from any track location of drive 1 to starting at any track location of drive 2. Copying will stop at the last data track (079) of the diskette in either drive.

2.4.2.8 TRACK FWD Key

The TRACK FWD key is active whenever an indicator (except DISK INITL and COPY 1 TO 2) is blinking; refer to Table 2-2.

MSU IV OPERATOR'S MANUAL
CONTROLS, INDICATORS, AND CONNECTORS

Sequentially pressing an active TRACK FWD key causes the selected drive (DRIVE 1 or DRIVE 2 indicator lit) to increment the location of the read/write head one track for each key pressing. The current track location for the selected drive is shown on the TRACK/STATUS indicator; refer to paragraph 2.4.3.1.

When the maximum track number (079) is reached, the next key pressing changes the read/write head and TRACK/STATUS indicator to either track zero (000) of the next drive if it is ready, or to track zero of the same drive if the other drive is not ready (door open, or no diskette inserted).

Holding the TRACK FWD key pressed for longer than one second will cause the track count to increment at a rate of about 10 tracks per second.

2.4.2.9 TRACK BACK Key

The TRACK BACK key is active whenever an indicator (except DISK INITL or COPY 1 TO 2) is blinking; refer to Table 2-2.

Sequentially pressing an active TRACK BACK key causes the selected drive (DRIVE 1 or DRIVE 2 indicator lit) to decrement the location of the read/write head one track for each key pressing. The current track location of the selected drive's read/write head is shown on the TRACK/STATUS indicator; refer to paragraph 2.4.3.1.

When track zero (000) is reached, the next key pressing returns the read/write head and TRACK/STATUS indicator to the last data track (079) on the next drive if it is ready, or on the same drive if the other drive is not ready (door open, diskette not inserted).

Holding the TRACK BACK key pressed for longer than one second will cause the track count to decrement at a rate of about 10 tracks per second.

2.4.2.10 SPEED SEL key

The SPEED SEL key is only operational when the MSU has been set for use in the RS-232 mode of operation, and the halted mode is selected. When the MSU is used with a DIGILOG DLM, speed is selected by the DLM. If the TRACK/STATUS indication is currently displaying a track or status, then the SPEED SEL key will change this display to show the current speed selection (all 3 segments displayed). The TRACK/STATUS will continue displaying speed until depression of TRACK BACK key, TRACK FWD key, or a STATUS requires being displayed. If the TRACK/STATUS indication is currently showing speed selection (all 3 segments displayed) then the SPEED SEL key will cause the record/playback speed and the TRACK/STATUS indication to change as shown in Table 2-5. This indication will always show all 3 segments lit when a speed indication is displayed, but only the 2 right hand segments are displayed if showing a track indication.

MSU IV OPERATOR'S MANUAL
CONTROLS, INDICATORS, AND CONNECTORS

2.4.2.11 RS-232/DLM Key

The RS-232/DLM key alternately selects one of the two modes of MSU IV operation. ON-RS232 OFF-DLM indicator will light when the RS-232 mode of operation is selected; the indicator will not light when the DLM mode is selected.

2.4.3 Indicators

MSU IV uses LED indicators to display status and operating modes. All indicators are on the front panel as shown in Figure 2-2. Table 2-3 contains a listing of the indicators along with a brief description of each indicator's function. In the following paragraphs, each indicator is discussed as to its relationship to control keys and functional modes.

2.4.3.1 TRACK/STATUS Indicator

The TRACK/STATUS indicator consists of the seven-segment LED displays, and it has five functions. First, the indicator shows the track location of the read/write head in the selected drive. This is a decimal number ranging between 00 to 79.

Second, when OPER SEL key has been pressed to light the READ TRACK indicator and a read operation is selected, the TRACK/STATUS indicator displays the data track being read; refer to paragraph 2.4.2.7.

Third, the TRACK/STATUS indicator displays the current track location of the read/write head when TRACK FWD or TRACK BACK keys are pressed; refer to paragraphs 2.4.2.8 and 2.4.2.9.

Fourth, the TRACK/STATUS indicator displays error and status messages. Paragraph 2-3 and Table 2-1 describe the error messages which are in the form of E plus two digits. Status messages are in the form of S and two digits. Status messages halt MSU IV operation either for operational reasons or due to equipment deficiencies. Table 2-4 presents and describes the status messages.

Fifth, the TRACK/STATUS indicator displays baud rate values in decimal when SPEED SEL key is pressed. Refer to Table 2-5 for speed selection.

MSU IV OPERATOR'S MANUAL
CONTROLS, INDICATORS, AND CONNECTORS

TABLE 2-3. FRONT PANEL INDICATORS

INDICATOR LEGEND	POWER ON STATE	FUNCTIONAL DESCRIPTION
TRACK/ STATUS	00	A 3-digit display that indicates track number, error number, status designator, or speed.
Activity indicators	OFF	Lighted (red) when selected drive is in operation. Located on drive.
DRIVE 1	ON	Lights to indicate drive 1 is selected for an operation.
DRIVE 2	OFF	Lights to indicate drive 2 is selected for an operation.
COPY 1 TO 2	OFF	Blinks when MSU IV is ready to copy data from drive 1 to drive 2. Lights steadily while copying is in progress.
DISK INITL	OFF	Blinks when MSU IV is ready to initialize diskette in selected drive. Lights steadily while initialization is in progress.
OFF-CONT	OFF	Lights to indicate that MSU IV will record continuously by selecting alternate drives.
ON-STOP	ON	Lights to indicate that MSU IV will halt recording when diskettes in both drives are full, or single drive if only one in use.
READ DISK	OFF	Blinks when MSU IV is ready to read data to the DLM from diskette in selected drive. Lights steadily while reading is in progress.
WRITE DISK	OFF	Blinks when MSU IV is ready to write data from the DLM to diskette in selected drive. Lights steadily while writing is in progress.
READ TRACK	OFF	Blinks when MSU IV is in the one-track-read mode and is ready to read. Lights steadily while a track of data is being read from a selected diskette.
FIND EVENT	OFF	Blinks when an event marker has been located. Lights steadily while an event mark search is in progress.

MSU IV OPERATOR'S MANUAL
CONTROLS, INDICATORS, AND CONNECTORS

TABLE 2-3. FRONT PANEL INDICATORS - Continued

INDICATOR LEGEND	POWER ON STATE	FUNCTIONAL DESCRIPTION
ON-RS232	ON	Lights to indicate the RS-232 mode of operation has been selected.
OFF-DLM	OFF	Does not light to indicate the DLM mode of operation has been selected.

TABLE 2-4. STATUS MESSAGES

MESSAGE	MEANING	REQUIRED ACTION
S01	An event mark was located during find event operation. Search stops.	Read present track of data, or track forward to search for additional event marks as desired.
S02	End of recorded data located during find event or data read operation. Operation stops.	Change diskette, or track back/forward to other data recorded, or run to continue selected mode.
S03	S01 and S02 (event marks) are on same tracks.	Same action required as for S02 above.
S04	Drive not ready. Cause may be drive failure, open latch, or no diskette in drive.	Check for presence of diskette and latch closed. If status message S04 persists, have MSU IV serviced; refer to paragraph 3.7.
S05	Write-protected diskette.	Remove write-protect tab from diskette (paragraph 2.4.1) or, if data on diskette is to be retained, replace diskette in drive with a nonprotected one.
S06	Initialize or copy invalid.	Replace diskette; if status message persists, have MSU IV serviced.
S07	RAM error during diagnostic.	Have MSU IV serviced.
S08	EPROM error detected in diagnostic.	Have MSU IV serviced.
S09	User selected speed is auto, detected speed mismatch.	Auto baud detect found idle line state or speed is too high to detect or playback using auto baud attempt.

MSU IV OPERATOR'S MANUAL
CONTROLS, INDICATORS, AND CONNECTORS

TABLE 2-5. SPEED SELECTION

SPEED SELECTED	TRACK/STATUS INDICATION
AUTO SET	Aut
50	050
75	075
110	110
134.5	134
150	150
300	300
600	600
1050	105
1200	120
1800	180
2000	200
2400	240
3600	360
4800	480
7200	720
9600	960
14400	144
16000	160
19200	192
40800	408
48000	480
56000	560
57600	576
72000	720

2.4.3.2 Disk Drive Activity Indicators

A disk drive activity indicator is provided on each drive. These indicators light steadily (red) when a read or write operation is in progress for a selected drive.

CAUTION

NEVER OPEN A DISK DRIVE UNIT WHILE THE ACTIVITY LIGHT IS ON. THIS WILL CAUSE DATA TO BE LOST, AND COULD CAUSE DAMAGE TO THE DISKETTE.

2.4.3.3 DRIVE 1 and DRIVE 2 Indicators

The DRIVE 1 or DRIVE 2 indicator lights steadily to show which drive is selected for subsequent operations. Drive selection is either automatic during read or write operations or manual by pressing the DRIVE SEL key. DRIVE 1 is selected and its indicator lights when power is first applied to the MSU IV.

2.4.3.4 COPY 1 TO 2 Indicator

The COPY 1 TO 2 indicator starts blinking when the OPER SEL key is pressed. This indicates that MSU IV is ready to copy data from diskette in drive 1 to diskette in drive 2.

Pressing RUN key starts the copying process and causes COPY 1 TO 2 indicator to light steadily. When copying is completed, COPY 1 TO 2 indicator returns to a blinking condition; refer to paragraph 2.4.2.7.

2.4.3.5 DISK INITL Indicator

The DISK INITL indicator starts blinking when the DISK INITL key is pressed. This indicates that a diskette is ready for initialization (formatting) in the selected drive.

MSU IV OPERATOR'S MANUAL
CONTROLS, INDICATORS, AND CONNECTORS

Pressing RUN key starts the initialization process and causes DISK INITL indicator to light steadily. When initialization is completed, DISK INITL indicator returns to blinking condition; refer to paragraph 2.4.2.2.

This function erases all data from a previously recorded diskette.

2.4.3.6 ON-STOP/OFF-CONT Indicator

The ON-STOP/OFF-CONT indicator lights to indicate that MSU IV is in the stop-full recording mode. MSU IV stops recording when diskette in drive 2 is full (if both used). When the ON-STOP/OFF-CONT indicator is not lit, it indicates that MSU IV is in the continuous recording mode. MSU IV alternately selects drive 1 or drive 2 for recording. Sequential pressings of STOP/CONT key alternately selects between stop-full recording and continuous recording mode.

2.4.3.7 READ DISK and WRITE DISK Indicators

The READ Disk and WRITE Disk indicators blink to indicate the selection of either read or write modes. Sequential pressings of the READ WRITE key alternately select read or write.

Pressing RUN key starts the indicated operation and causes the blinking READ DISK or WRITE DISK indicator to light steadily. Pressing HALT key stops the read or write operation and returns READ DISK or WRITE DISK indicator to blinking condition; refer to paragraph 2.4.2.4.

2.4.3.8 READ TRACK Indicator

The READ TRACK indicator blinks to indicate that a one-track-read mode (2,500 bytes) has been selected by pressing the OPER SEL key.

When the RUN key is pressed, READ TRACK indicator lights steadily and the track indicated by the TRACK/STATUS indicator is read (for selected drive). After the track is read, the read cycle stops, the unit halts, and READ TRACK indicator returns to blinking condition.

2.4.3.9 FIND EVENT Indicator

The FIND EVENT indicator lights steadily indicating that MSU IV is searching the diskette in the drive selected for a track of data containing an event mark. This operation is initiated by pressing MSU IV keys OPER SEL and RUN.

The FIND EVENT indicator blinks to indicate that an event mark (S01, S02, or S03) has been found and drive selected has stopped searching. Read the current track of data to find the character sequence of interest.

MSU IV OPERATOR'S MANUAL
CONTROLS, INDICATORS, AND CONNECTORS

2.4.3.10 ON-RS232/OFF-DLM Indicator

The ON-RS232/OFF-DLM indicator lights to indicate that MSU IV is in the standalone RS-232 mode of operation. When the ON-RS232/OFF-DLM indicator is not lit, it indicates that the MSU IV is in the DLM indicator mode. Sequential pressings of the RS-232/DLM key alternately selects between the RS-232 and the DLM mode.

2.5 REAR PANEL CONNECTORS

The MSU IV rear panel has data interface consisting of four 25-pin female connectors (DB25S) labeled DLM INTERFACE, TO DTE, TO DCE, and OUTPUT; see Figure 2-1, and refer to Table 2-6. This connector provides a parallel data interface to the DLM.

All signals at the INTERFACE connector are TTL levels:

Low = 0 = 0.0 to +0.8 vdc

High = 1 = +2.0 to +5.0 vdc.

Signals at all other connectors are 0 or +12 vdc.

TABLE 2-6. REAR PANEL CONNECTOR
PIN DESIGNATIONS

DIGILOG DLM INTERFACE CONNECTOR	
PIN	FUNCTION
1	<div style="display: flex; align-items: center;"> <div style="margin-right: 10px;">Bidirectional Data Bus</div> <div style="font-size: 3em; margin-right: 5px;">}</div> <div style="display: flex; flex-direction: column; gap: 5px;"> D0 D1 D2 D3 D4 D5 D6 D7 </div> </div>
2	
3	
4	
5	
6	
7	
8	
9	Write strobe from DLM. Low true, pulse width = 25 μ sec.

MSU IV OPERATOR'S MANUAL
CONTROLS, INDICATORS, AND CONNECTORS

Table 2-6. REAR PANEL CONNECTOR
PIN DESIGNATIONS - Continued

DIGILOG DLM INTERFACE CONNECTOR	
PIN	FUNCTION
10	Signal ground
11	Read clock from DLM. Controls rate of data transfer from MSU IV to DLM.
12	Signal ground.
13	Read data strobe to DLM. Strokes data from MSU IV to DLM. Low true; pulse width = 24 second.
14	Read/write status line from MSU IV to DLLM. Low = read mode. High = write mode.
15	Read status line from DLM to MSU IV. Low = DLM in read mode. High = DLM <u>not</u> in read mode.
16 thru 25	Not used.
TO DTE CONNECTOR TO DCE CONNECTOR OUTPUT CONNECTOR	
2	Send data
3	Receive data
4	Request to send
5	Clear to send
6	Data set ready
7	Signal ground
8	Carrier detect

MSU IV OPERATOR'S MANUAL
 CONTROLS, INDICATORS, AND CONNECTORS

TABLE 2-6. REAR PANEL CONNECTOR
 PIN DESIGNATIONS - Continued

	TO DTE CONNECTOR TO DCE CONNECTOR OUTPUT CONNECTOR
PIN	FUNCTION
11*	Send clock status
15	Send clock
17	Receive clock
18*	Receive clock status
20	Data terminal ready
21	Signal quality
All other pins	Not used

*Used in OUTPUT connector only

CHAPTER 3

OPERATION

3.1 INTRODUCTION

This chapter describes how to prepare MSU IV for use with a DLM and in a standalone RS-232 mode for communications network testing. Included in this chapter are instructions for connecting MSU IV to the DLM and for the RS-232 modes; accomplishing an equipment self-test; information on diskette initialization and organization; and instructions for using MSU IV in the read, write, and copy modes. Also included are instructions for using MSU IV with one disk drive inactive.

3.2 DLM INTERFACE CONNECTIONS AND SELF-TEST

Connect a DLM into the communication system as described in the DLM Operator's Manual.

Connect DLM INTERFACE connector of MSU IV to MSU INTERFACE connector of the DLM using the 15 pin to 25 pin ribbon cable supplied with the MSU IV; refer to Figure 3-1.

Apply power to MSU IV by setting the unit's rear panel POWER switch to ON; refer to Figure 2-1. MSU IV automatically performs a test of its indicators and an internal diagnostic self-test each time the unit is turned on; refer to Table 2-1.

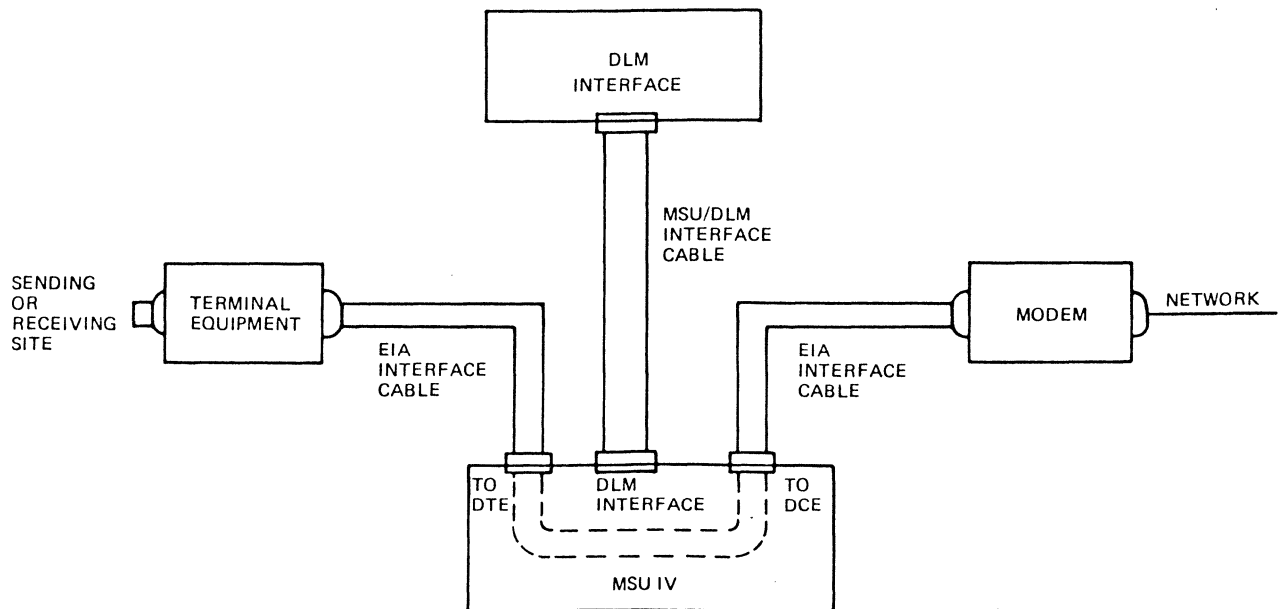

FIGURE 3-1. MSU IV AND DLM CABLE CONNECTIONS

MSU IV OPERATOR'S MANUAL
OPERATION

Upon successful completion of the indicator and self-tests, DRIVE 1 indicators are lit, TRACK/STATUS indicator displays 00, and all others are out.

If MSU IV fails the self-test, the TRACK/STATUS indicator displays an E and a two-digit error code; refer to Table 2-1 for required action. An internal RAM or EPROM fault will cause an error number to be displayed.

If a status message is displayed on indicator TRACK/STATUS during operation, MSU IV will stop.

3.3 RS-232 INTERFACE CONNECTIONS

Connect the DTE or DCE connector of the DLM to the MSU IV OUTPUT connector using a 25 pin RS-232 cable; refer to Figure 3-2.

Apply power to MSU IV by setting the unit's rear panel POWER switch to ON; refer to Figure 2-1. Press RS-232 key to light ON-RS232/OFF DLM indicator. If recording speed is to be selected, press SPEED SEL key. The speed selected will appear on the TRACK/STATUS indicator

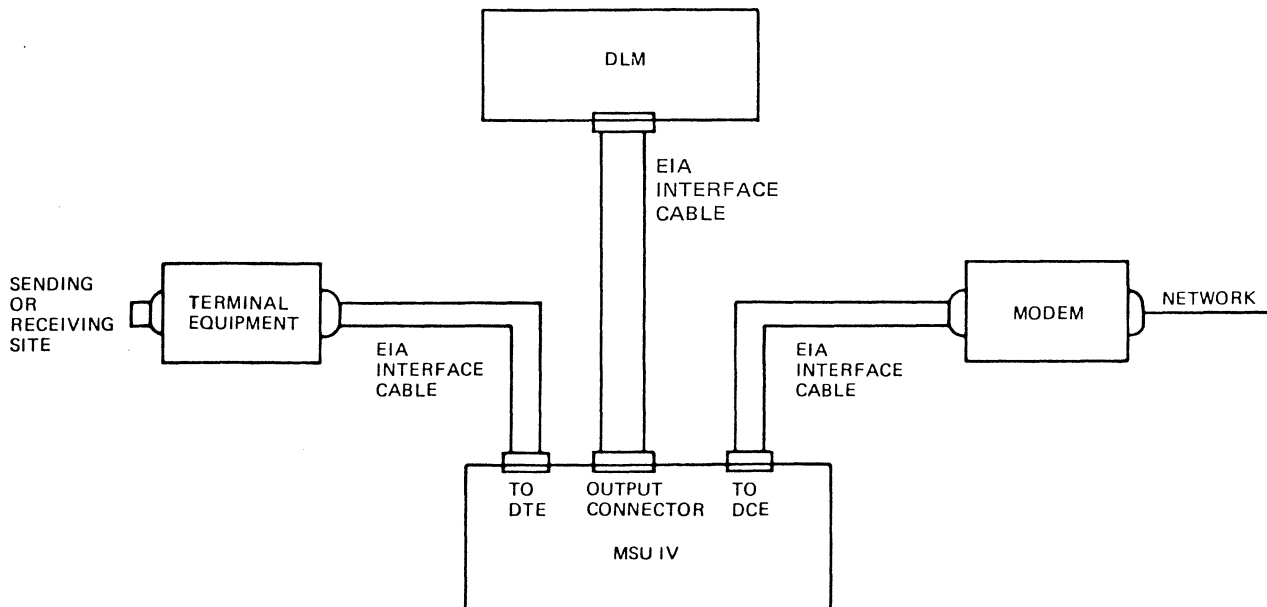

FIGURE 3-2. RS-232 MODE CONNECTIONS

MSU IV OPERATOR'S MANUAL OPERATION

Upon completion of the indicator and self-tests, DRIVE 1 and DLM indicators are lit, TRACK/STATUS indicator displays 00, and all other indicators are not lit.

3.4 DISK INITIALIZATION AND ORGANIZATION

Diskettes are basically disks of mylar film coated with a thin layer of iron oxide. The recording medium is similar in concept to magnetic recording tape. Each diskette is contained in a protective cardboard envelope, or jacket; the diskette and envelope together are inserted into the disk drive.

Data is recorded on diskettes in groups referred to as tracks. Diskettes do not physically contain tracks; they are imposed upon the recording medium of the diskette by the recording device (the MSU IV).

Tracks are in the form of a unique data pattern written onto the diskette. The data pattern identifies the start of each track and includes the track number. Track length is one complete diskette rotation. There are 40 data tracks, numbered 00 through 39, on each side of the diskette.

MSU IV begins reading or writing on side 1 of drive 1 and at track 00. When track 39 is reached, the second side of the diskette is accessed; track count now goes from 40 to 79. When the second side of the diskette in drive 1 is finished, MSU IV switches to either drive 2, side 1, or to a previously selected track. Track count now returns to 00 (or the number of the previously selected track) and progresses through 39 and then 40 through 79 as both sides of the diskette are used.

Diskettes must be formatted (initialized) in MSU IV prior to writing data onto them. It is up to the operator to ensure that enough formatted diskettes are on hand to satisfy immediate needs.

Diskettes can be formatted on any MSU IV; also, MSU IV need not be connected to a DLM for diskette formatting. The following is the diskette formatting procedure.

1. Apply power to MSU IV.
2. Remove write-protect tabs from diskettes to be formatted.
3. Insert diskettes into the drives. Close the drives' latches.
4. Depress DISK INITL key and observe that indicator DISK INITL blinks.
5. Depress RUN key, and observe that indicator DISK INITL lights steadily; the diskette is now being formatted, and indicator TRACK/STATUS increments from 00 to 79.

MSU IV OPERATOR'S MANUAL
OPERATION

6. The formatting process is completed after about 80 seconds.
Manually select the second drive and repeat steps 4 and 5.
Open the latch on the now inactive drive and remove the formatted diskette. Insert a fresh diskette with the write-protect tab removed.
7. Repeat the above procedure until all diskettes are formatted.
When last diskette is formatted, other operating modes can be selected.

CAUTION

USE ONLY FELT-TIP MARKERS AND NEVER A PENCIL OR BALLPOINT PEN. APPLYING TOO MUCH PRESSURE TO A DISKETTE'S JACKET WILL HARM THE SURFACE OF THE DISKETTE.

8. Note on diskettes' labels that they are formatted.

Refer to Figure 2-4 for proper diskette handling procedures.

3.5 RECORDING DATA

The following paragraphs describe using MSU IV with DLM to record data in two recording modes (attended and unattended). The paragraph also describes how to connect the MSU IV and DLM to view data before and after recording and record data from a standalone RS-232 communication line.

CAUTION

NEVER OPEN A DRIVE DOOR WHILE THE DRIVE'S ACTIVITY LIGHT IS LIT. THIS CAN RESULT IN INVALID DATA BEING RECORDED, AND COULD CAUSE DAMAGE TO THE DISKETTE.

3.5.1 Manual (Attended) Data Recording

In the manual data recording mode, the operator makes data-related decisions and MSU IV controls selections. Manual data recording assumes that MSU IV is connected to either a DLM that is, in turn, connected into a communication system or directly to the data line; refer to paragraph 3.2.

MSU IV OPERATOR'S MANUAL
OPERATION

The following is the general procedure to be used in attended (on-line) data recording:

1. Apply power to MSU IV and DLM.
2. Set up the DLM for continuous operation while it is in HALT mode.
3. Insert a blank, formatted diskette with write-protect tab removed into each MSU IV drive; close the drives' latches.
4. Select continuous or stop-full recording on the MSU IV:

If stop-full recording is desired, press the STOP/CONT key; the ON-STOP/OFF-CONT indicator lights.

If continuous recording is desired, press the STOP/CONT key; the ON-STOP/OFF-CONT indicator does not light.

5. Press READ WRITE key until WRITE DISK indicator is blinking.
6. Press RUN key; WRITE DISK indicator lights steadily. MSU IV is now ready to receive data from the DLM.
7. Place DLM into RUN mode (speed selected by DLM or MSU IV).
8. Observe the DRIVE 1 and DRIVE 2 indicators. MSU IV begins recording on currently selected drive. When the diskette on this drive is full, recording switches to other drive.

If stop-full recording was selected, recording process stops when drive 2 diskette is full. The TRACK/STATUS indicator then displays 00 and the WRITE DISK indicator blinks.

If continuous recording is selected and more than 400k bytes of data are going to be read, then the operator must continually monitor both the DRIVE 1 and DRIVE 2 indicators.

When DRIVE 1 indicator goes out during continuous operation, immediately exchange diskette in drive 1 with a fresh one having write-protect tab removed. Approximately 30 seconds are available for changing diskettes (baud rate dependent). Alternately renew diskettes in drives 1 and 2 as their respective DRIVE indicators go out. This procedure maintains a continuous data record.

If a continuous data record is not desired but continuous monitoring for certain events is wanted, allow MSU IV to run in continuous mode but do not renew diskettes. Old data will be over-written by new data.

MSU IV OPERATOR'S MANUAL
OPERATION

The EVENT MARK key is used to mark events of interest. If such an event occurs while monitoring the DLM, immediately press the EVENT MARK key. This places a mark on the track near the character sequence of interest that may be searched for during playback.

NOTE

THE EVENT MARK ITSELF IS NOT A DISPLAYABLE CHARACTER,
AND WILL NOT BE SEEN ON THE DLM VIDEO DISPLAY.

3.5.2 Automatic (Unattended) Data Recording With A DIGILOG DLM

In the unattended data recording mode, MSU IV stops recording when certain events, pre-programmed at the DLM, are detected. Unattended data recording assumes that MSU IV is connected to the MSU connector of a DLM that is, in turn, connected into a communication system; refer to paragraph 3.2.

The following is the general procedure to be used for unattended data recording.

1. Apply power to MSU IV and DLM.
2. Set up DLM for stop-immediate, or stop full operation (on trap or CRC data errors as desired) while it is in HALT mode.
3. Insert a blank, formatted diskette with write-protect tab removed into each MSU IV drive. Close the drives' latches.
4. Select continuous recording by pressing key STOP/CONT until ON-STOP/OFF-CONT indicator is OFF.
5. Press READ WRITE key until WRITE DISK indicator is blinking.
6. Press RUN key; WRITE DISK indicator lights steadily. MSU IV is now ready to receive data from the DLM.
7. Place DLM into RUN mode.
8. The DLM and MSU IV now run continuously; recording stops when trap or CRC errors, pre-programmed at the DLM, are found.

Either the trap sequence or the error condition appears on the DLM's screen and is recorded on the diskette by the MSU IV as a blinking character.

MSU IV OPERATOR'S MANUAL
OPERATION

continue recording data after trap or error conditions occur, place DLM in RUN mode. At the end of a write operation, an S02 event mark is automatically recorded in order to identify the location of a manual stop or start that may have occurred in the middle of data that are recorded on the diskette.

3.5.3 View Data Before Recording

Figure 3-3 shows how to interconnect a DLM and the MSU IV to allow the operator to view data on the DLM prior to its being recorded at the MSU IV. Connect the DLM and MSU IV from DCE to DTE connectors using an EIA interface cable. Connect the terminal equipment to the DLM DTE connector and connect the modem to the MSU IV DCE connector; use EIA interface cables in both instances.

Apply power to MSU IV by setting the unit's rear panel POWER switch to ON; refer to Figure 2-1. MSU IV automatically performs a test of its indicators and an internal diagnostic self-test each time the unit is turned on; refer to Table 2-1.

Upon successful completion of the indicator and self-tests, DRIVE 1 indicators are lit, TRACK/STATUS indicator displays 00, and all others are out.

If MSU IV fails the self-test, the TRACK/STATUS indicator displays an E and a two-digit error code; refer to Table 2-1 for required action. An internal RAM or EPROM fault will cause an error number to be displayed.

If a status message is displayed on indicator TRACK/STATUS during operation, MSU IV will stop.

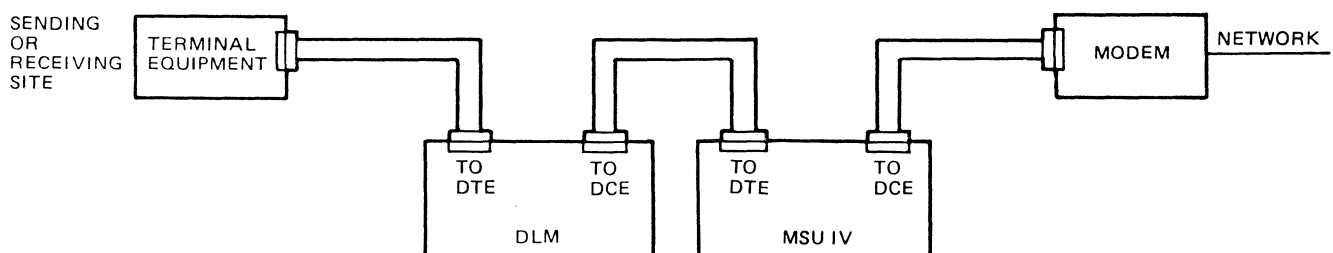

FIGURE 3-3. VIEW DATA BEFORE RECORDING

MSU IV OPERATOR'S MANUAL
OPERATION

3.5.4 View Data After Recording

Figure 3-4 shows how to interconnect a DLM and the MSU IV to allow the operator to view data on the DLM after it has passed through the MSU IV. Connect the DCE connector of the MSU IV to the DCE connector of the DLM using an EIA interface cable. Connect the terminal equipment to the MSU IV DTE connector and connect the modem to the DLM DCE connector; use EIA interface cables in both instances.

Turn-on procedures and other operations are as discussed in paragraph 3.5.3 (View Data Before Recording).

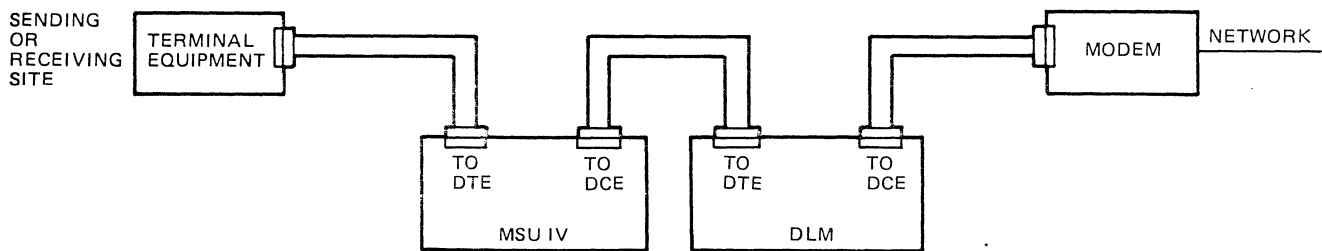

FIGURE 3-4. VIEW DATA AFTER RECORDING

3.5.5 Standalone (RS-232) Recording

Figure 3-5 shows how to connect the MSU IV to record digital data directly from a RS-232 communication line. Connect the terminal equipment to the MSU IV DTE connector and connect the modem to the MSU IV DCE connector, use EIA interface cables in both places.

Turn-on procedures and other operations are as discussed in paragraph 3.5.3 (View Data Before Recording).

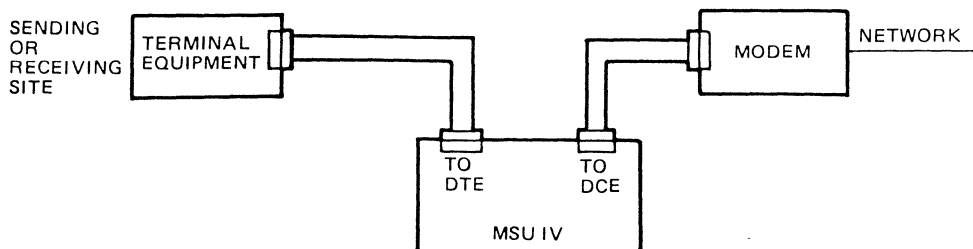

FIGURE 3-5. STANDALONE (RS-232) RECORDING

MSU IV OPERATOR'S MANUAL OPERATION

3.13 PLAYING BACK DATA

MSU IV can play back recorded data for analysis on the DLM. MSU IV and DLM must be interconnected; however, they need not be connected into a communication system (this is off-line operation). Data may be played back and analyzed on any MSU IV/DLM combination using diskettes recorded at a remote location. Recorded data must be played back in the same mode used to record the data. RS-232 mode recorded data will not play back in the DLM mode and vice versa. The wrong playback mode is indicated by error message E08 in the TRACK/STATUS indicator.

The following is the general procedure to be used for playing back data from the DLM connector of MSU IV to the MSU connector of the DLM.

1. Apply power to MSU IV and DLM.
2. Connect the 15 pin to 25 pin ribbon cable supplied with the MSU IV from the MSU IV DLM connector to the DLM MSU connector.
3. Insert recorded diskettes into both disk drives and close the drives' latches. Protect data on the diskettes with write-protect tabs as required.
4. Set up desired DLM analysis mode.
5. Press READ WRITE key on MSU IV until indicator READ DISK is blinking.
6. Operate DLM in HALT mode.
7. Press DLM MSU READ key (BUFF CLEAR key on retrofitted DLM III units).
8. Press MSU IV's RUN key; READ DISK indicator lights steadily, and the message "MSU READ" appears on the lower part of the DLM's screen. MSU IV now serves as an extended memory for the DLM.

See Figure 3-1 for set up.

All basic DLM operations can now be accomplished using data from the diskettes.

If trap or error conditions are pre-programmed at the DLM in order to analyze data read from diskettes, no characters are lost when the DLM stops to acknowledge the programmed condition. When the DLM is restarted, the next contiguous character is read into the DLM's buffer (assuming continuous operation after the halt took place).

Long data read sequences, using multiple diskettes, can be accomplished by replacing the diskette in a drive whose activity has stopped with the next diskette in the sequence.

DLM continuous and stop-full modes are fully operational using MSU IV. Data from MSU IV is still input via the DLM buffer; the DLM stops and starts the MSU IV data readout as needed to supply its buffer. MSU IV also provides several unique operations: read, find event, and track forward/back.

MSU IV OPERATOR'S MANUAL
OPERATION

3.6.1 READ TRACK Operations

The read track mode allows data to be read from diskette in single-track increments, and each track can contain up to 2,500 bytes of data (not including status bytes). This mode can be used with find event operation. After the desired track is read, the reading operation stops. This mode is an alternative to the read mode, wherein data tracks are read continually and sequentially.

To operate MSU IV in read track mode, proceed as follows:

1. Operate MSU IV and the DLM for data playback as described in paragraph 3.6.
2. Press MSU IV OPER SEL key; READ TRACK indicator blinks.
3. Press MSU IV RUN key; READ TRACK indicator lights steadily. MSU IV reads data track shown on TRACK/STATUS indicator.
4. After data track is read, reading operation stops; indicator READ TRACK returns to blinking.
5. One data track is read for each subsequent pressing of the RUN key. Indicator TRACK/STATUS increments to show the number of the track being read.

3.6.2 FIND EVENT Operations

The find event mode allows data of interest, previously marked by use of key EVENT MARK, to be located and read into the DLM for analysis. After the event mark is found, data can be read either continuously or in block format.

To use the find event mode, proceed as follows:

1. Operate MSU IV and the DLM for data playback as described in paragraph 3.6.
2. Press OPER SEL key; indicator FIND EVENT blinks.
3. Press MSU IV key RUN; indicator FIND EVENT lights steadily to show that an event mark search is in progress.
4. If a track containing an event mark is found, then indicator FIND EVENT resumes blinking, the search stops and indicator TRACK/STATUS displays S01, indicating an event mark found; S02, indicating end of recorded data found; or S03, if both the conditions for S01 and S02 are true.

MSU IV OPERATOR'S MANUAL
OPERATION

5. If data are to be read continuously from event mark, press READ key to turn off FIND EVENT indicator. Next press RUN key. Data will be read from the beginning of the track containing the event mark.

NOTE

THE EVENT MARK ITSELF IS NOT A DISPLAYABLE CHARACTER,
AND WILL NEVER BE SEEN.

If a track-read of data is to be performed after the event mark is found, press the OPER SEL key; refer to paragraph 3.6.1.

6. To find the next event mark while find-event mode is active, first press TRACK FWD, then RUN key; refer to Table 2-4.

3.6.3 TRACK FORWARD/BACK Operations

Track forward/back operations are useful with find event operations because they allow the track count to be increased or decreased in the area of a located event mark. This gives the user flexibility in data analysis just before and after an event.

The following is a general procedure for using track forward/back operation. Specific use for analysis of a given event is up to the user.

1. Operate MSU IV and the DLM for data playback as described in paragraph 3.6.
2. Locate event of interest; refer to paragraph 3.6.2.
3. To increase the track count, press TRACK FWD key; indicator TRACK/STATUS increases one count for each key pressing.

Holding key pressed for longer than one second causes the count to increase rapidly (10 tracks/second).

To decrease the track count, press TRACK BACK; indicator TRACK/STATUS decreases one track for each key pressing.

Holding key pressed for longer than one second causes the count to decrease rapidly (10 tracks per second).

4. Read data either continuously or in block format as desired.

MSU IV OPERATOR'S MANUAL
OPERATION

3.7 COPYING DISKS

MSU IV can copy diskettes. This feature is useful for making file-copy diskettes of unique or important data, and for making multiple copies of diskettes for training purposes.

Diskette copying can be done without MSU IV being connected to the DLM. Copying must be done from drive 1 to drive 2. The following is the procedure for diskette copying:

1. Apply power to MSU IV.
2. Insert diskette to be copied into drive 1 and close the drive latch. Use write-protect tab to protect data as required.
3. Insert a blank (initialized) diskette (with write-protect tab removed) into drive 2. Close drive latch.
4. Sequentially press OPER SEL key until COPY 1 TO 2 indicator blinks.
5. Press RUN key and observe that COPY 1 TO 2 indicator lights steadily; diskette is now being copied. DRIVE 1 and DRIVE 2 drive activity indicators alternately light and show drives are reading and writing.
6. After about 80 seconds the copying process is completed. COPY 1 TO 2 indicator returns to blinking condition.
7. Open drive 2 latch and remove diskette. Apply a write-protect tab to secure diskette contents. Note the diskette contents on the diskette label using a felt-tip marker. NEVER use a pencil or ballpoint; excessive pressure on the jacket of the diskette can damage the diskette recording surface.
8. If additional copies of the diskette in drive 1 are to be made, insert another blank, formatted diskette into drive 2; close the drive latch, and press the RUN key.

If copying process is complete, open drive 1's latch and remove the master diskette.

NOTE

A READ AFTER WRITE CHECK IS DONE DURING THE COPYING OPERATION TO ENSURE INTEGRITY OF THE DATA RECORDED ON THE DISKETTE IN DRIVE 2.

MSU IV OPERATOR'S MANUAL
OPERATION

OPERATION WITH ONE DRIVE INACTIVE

If the TRACK/STATUS indicator displays S04, a problem exists with the disk drive displaying a lighted DRIVE indicator.

Before having the unit serviced, check all obvious causes of drive problems such as latch not closed, no diskette in drive, or damaged diskette. If no obvious problems are found, MSU IV may be operated temporarily using one drive.

With only one drive, all modes of operation except diskette copying and two-diskette continuous operation are possible.

Leave the latch open and do not insert a diskette in the unused drive.

When recording data, select the functioning drive and either continuous or stop-full operation. During stop-full operation, replace the diskette when a blinking WRITE DISK indicator shows that the last data track has been written to.

During one-disk continuous recording, select the functioning drive and continuous operation. When side 2 of the disk is full, MSU IV returns to side 1 and over-writes the existing data.

To read continuously from one diskette, select the read mode as for two-diskette operation; however, leave the unused drive empty and leave the latch open. Both sides of diskette are read alternately.

MSU IV
OPERATOR'S INSTRUCTION MANUAL

DIGILOG
NETWORK CONTROL DIVISION
1370 WELSH ROAD, MONTGOMERYVILLE, PA 18936
(215) 628-4530 TWX 510-661-0060